

ENDO

e catalogue
Belanja Cepat Cara Tepat



LKPP
Lembaga Kebijakan
Pengadaan Barang/Jasa Pemerintah



2025

PRODUCT CATALOG

PT ENDO Indonesia



ENDO



PT ENDO Indonesia

PT ENDO Indonesia was founded in 2006 as a company engaged in importation and distribution of Medical Devices. Today, among many others, our product portfolio consists of Electromedical Devices, Instruments, Disposables, Orthopaedic Implants, and accessories. Since 2012 we established a subsidiary company named PT. Meditronik Hospilab Indonesia specializing in manufacturing. The products made at the moment are Medical Chart Paper and Electromedics.

Our Vision

"Improving health care of Indonesian society by providing good quality products at affordable prices."

Our Mision

"Consistent development and continuously increasing employee's well-being while maintaining integrity in daily routines."



Improving Healthcare
Providing high quality products at affordable prices



Qualified Personnels
Experienced staffs in their respective fields



Networking
Through doctors, hospitals, distributors, and resellers



Fast Delivery
Most products are ready in stock

EXCLUSIVE DISTRIBUTORS

TONTARRA



SEESHEEN



AYGÜN
SURGICAL INSTRUMENTS CO., INC.

ELMED

KANG JIAN

aselsan

AGS



iMEDICOM
Intended for Veterinary



Romsons



Potent

SEPLOU
MEDICAL

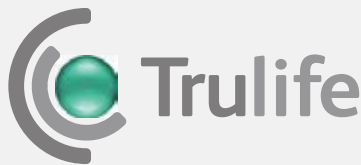

GUARDIAN



NELIS



Sinolinks

endovision
infinite vision of the medical device



STERIX

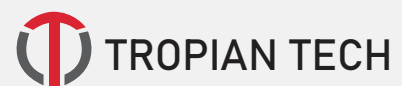

WASTON
MEDICAL

EZLIG

GERUI





Spirobank II Advanced
Spirometer

Accurate, Complete and Easy to use Spirometer with Oximetry option. 4 versions available : Smart, Basic, Advanced, and Advanced plus. Memory up to 10.000 Spirometry tests or 900 hours of Oximetry recording



Spirolab
Spirometer

Each function can be activated by a simple touch on the intuitive bar menu, always present on the screen. 7 inch Touchscreen. Database up to 10,000 Spirometry tests or 900 hours of Oximetry recording coupled with power and flexible search services.



Smart One
FEV1 and Peak Flow Meter

Simple and lightweight to carry on the go MIR Smart One App includes an exclusive Incentive for adults and children based on both exhaled Flow and Volume that is helpful in improving subject's compliance.



Bell Plus
Audiometer

Bell is extremely compact and lightweight and easy to carry in its dedicated case. Intensity AC : -10 to 120 dB HL, BC : -10 to 80 dB HL. Frequency range : 125 - 8000 Hz Input : tone, warble tone. Masking : WN (Plus), NBN.



Harp Plus
Audiometer

Harp features a large, bright graphic colour display, on which you can view the complete audiogram during the examination. Intensity AC : -10 to 120 dB HL, BC : -10 to 80 dB HL. Input : tone, warble tone, external source (tape, CD) 1-2, mic, flash memory (only in Plus Model)



Piano Plus VRA
Audiometer

Piano is the top-level audiometer in our portfolio, Besides the pediatric audiometry. Piano Plus VRA features a complete test battery, including the High Frequency audiometry. Channel : two separate and identical channel.



Flute Plus
Tympanometer

Flute is a diagnostic middle ear analyzer, capable of performing incredibly fast and reliable automatic sequences of tympanometry and reflex threshold tests, as well as manual reflex and reflex decay tests, ETF test, and high frequency tympanometry.



Viola Basic
Tympanometer + Audiometer

Viola has a very small footprint, just 2 kg of weight that allows to carry the entire diagnostic station in a small suitcase. Viola is available in two models: Basic and Plus. The following table is an overview of the tests available on each version.



EEG Digitrack
Electroencephalography

Advanced electrocorticographic mapping to automatically recognize and register signals from all types of reference electrodes. Ability to connect with a corticographic stimulator. Automatic artefact detection.



AED
Automated External Defibrillator

A rhythm analysis algorithm to detect shockable cardiac rhythms with high accuracy. Full-Automated and Semi-automated operating modes. CPR support by audio and visual instructions.



ENDO D1
Defibrillator Monitor

Comprehensive function With Defibrillation, Pacing, Monitoring and AED mode, S5 is not only suitable for pre-hospital first aid, but also applicable in in-hospital usage. Manual defibrillation modes include synchronous cardioversion and asynchronous defibrillation.



ENDO D2
Defibrillator Monitor

Having on-demand pacing and fixed pacing mode, for patients with cardiac arrest and acute severe slow arrhythmia, in vitro non-invasive pacing mode is rapid, easy to master, time-saving and improve recovery success rate. The model applies patented analysis algorithm and automated analysis as well as convenient setting to guide clinical emergency personnel in providing defibrillation and basic life support.



ENDO JRWD6012

Power Wheelchair

Features : Foldable directly. Removable battery box for recharging. Controller can be exchanged from right side to the left. Long driving distance, up to 25 km.



ENDO ANM1

Anesthesia Machine

More accurate, Safer and More Convenient. CE marked, meet EU clinical requirements. ISO quality guarantee. Suitable for adult and pediatric. Pin-Index for N2O/O2 Cylinder. Integrated high temperature sterilization and CO2 absorber system. Newly-developed reliable gas system. Compensation Flow, pressure, temperature compensation



ENDO ANM2

Anesthesia Machine

Multifunction, More Accurate. Internal 8" TFT Screen, Flexible Monitoring Angle. Integrated CO2 Absorber system, easy to disassemble and Assemble components, clean and Maintain. Two station Selectatec Back bar vaporizer. The highest quality and reliability vaporizer with Temperatures, Pressure and flowing compensa.



ENDO ANM3

Anesthesia Machine

CE marked, meet EU clinical requirements. Contemporary & ergonomic designed for ease of use Pull handle. DIN rail at both side of machine allows for flexibility and ease of mounting patient monitor other expansion medical devices. Optional integrated auxiliary O2 flowmeter and suction control. AGSS (Anesthesia Gas Scavenging System) is optional.



ENDO 2000E

Surgical Table Electro Hydraulic

ENDO Surgical Table Electro Hydraulic ENDO 2000E is designed to accommodate different patient positions required for demanding surgical procedures, with an ultimate focus on patient and user safety. ENDO 2000E Surgical Table is constructed with stainless steel and high quality materials to provide durability and long operating life.



ENDO 550S

Surgical Table Hydraulic

ENDO Surgical Table Hydraulic ENDO 550S are designed to accommodate various type of patient positioning required for demanding surgical procedures with ultimate care to the patient's and user's safety. Surgical Tables are constructed with stainless steel and high quality materials to provide durability and long operating life.



ENDO Ventilator V1
Portable Emergency Ventilator

Ventilation Mode : VCV, PCV, SIMV, SPONT, SIGH, MAN VT 50-1500 ml. Frequency 480 bpm. Inspiratory time 0.2~1 Os. Pressure trigger sensitivity. Flow trigger sensitivity 1 ~20 L/min. PEEP 0~20 cmH2O PInsp 5-80 cmH2O FiO2 45-100%



ENDO Ventilator V2.2
ICU Ventilator

Display Size : 18.5 inch-TFT Touch Screen Display. Resolution (H) x (V) : 1080 * 1920 pixels. Brightness : Adjustable. Patient Type. Invasive Ventilation Mode. Non-invasive Ventilation Mode. Battery Running Time: 3 hours (1 Qty Battery) & 6 hours (2 Qty Battery)



ENDO Ventilator V3
ICU Ventilator

With heating function, the expiratory valve protects the device from condensed water, accuracy of the flow sensor is ensure. Easy setting by navigator wheel knob and touch key Wide choice of ventilation modes including CPAP, APRV, BIPAP. Flow and pressure trigger. Static compliance and resistance monitor.



ENDO Ventilator V5
ICU Ventilator

Sleek, stable and highly mobile, this trolley is an all-in-one, comprehensive solution Easy to assemble and disassemble components on the trolley. Hold a full range of compatible accessories. Provide great convenience and ease-of-use when ventilating and moving patients.



ENDO BC
Bubble CPAP

Stable input: At the air inlet end AIR / O2 we adopted GENTEC gas connector and hose; the connector is made of high-quality device is installed internally to allow the clean gas source delivering steadily.

AKD PRODUCT

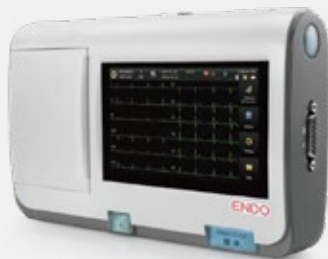

ENDO ECG EI.TC.ECG3

Electrocardiograph 3 Channel

Powerful External Device Support SE-301 arms with two USB ports and one microSD card slot, which extends its capability by supporting various external devices such as barcode scanner, external printer, USB Memory Drive as well as microSD card.

AKD PRODUCT



ENDO ECG EI-ECG3Ch

Electrocardiograph 3 Channel

Foldable LCD screen with waveform display and parameters configurable. High resolution thermal printer. Built-in rechargeable lithium battery, AC/DC power supply. Well designed membrane keyboard. Multi-languages selectable.

AKD PRODUCT



ENDO ECG EI-ECG12Ch

Electrocardiograph 12 Channel

User friendly design. 7" high resolution color touch screen. Streamlined workflow. One touch operation. Support barcode scanner to simplify workflow. Accurate clinical performances. Weak signal detection with the advanced 24-bit A/D converter technology.

AKD PRODUCT



ENDO EI.PC.ECG

PC Electrocardiograph

Dimensions 148 x 100 x 40 mm. Weight approx. 210 grams. Lead mode : 12 standard leads / Cbrera leads. Acquisition mode 12 leads simultaneously. Rate sampling 1000 / sec channel 24 bits A/D resolution. Time constant 3.2s. Frequency response 0.05Hz-150Hz (-3dB)

AKD PRODUCT



ENDO EI.PC.ECG+Treadmill

PC ECG + Treadmill Stress Test

ENDO Exercise ECG Test + Treadmill system providing comprehensive solutions for both stress ECG and resting ECG. Compatible with leading Treadmills (Trackmaster, h/p/cosmos and Lode), Bicycles (Ergoline and Ergosana) and Blood pressure monitor (Suntech).

AKD PRODUCT



ENDO EI.PO

Pulse Oxymeter

Type of protection against electric shock : II (Internal powered equipment). Degree of protection against electric shock : Type BF. Operation Mode : On-site inspection. Level of protection against explosion hazard : Common equipment: not protected.

AKD PRODUCT



ENDO EI.PO3 Pulse Oxymeter

Measured Parameters : SpO2 + PR. LCD display with backlight control. Dual work modes : monitoring and spot check. Numeric display with plethysmogram display. Trend review. Pulse-tone modulation (Pitch Tone). Adjustable audio and visual alarms

AKD PRODUCT



ENDO EI.PO7 Pulse Oxymeter

Pulse Oximeter adopts Photoelectric Oxyhemoglobin Inspection Technology integrated with Capacity Pulse Scanning & Recording Technology, which can be used to measure human oxygen saturation and pulse rate through finger.

AKD PRODUCT



ENDO EI.SP Syringe Pump

Self-testing - Every time the unit is turns on, self testing is proceeded. Auto-syringe detection size automatically. Shortcut key - Syringe brand set, Occlusion set, Buzzer level set. Infusion Setup - Flow rate/ Delivery volume/ Infusing time.

AKD PRODUCT



ENDO EI.SP3 Syringe Pump

The display is a 3.5" touch screen with a resolution of 480x320 and a brightness level that can be adjusted from 1-10 levels. Infusion mode: rate mode, time mode, VTBI, BW mode with 5, 10, 20, 30, 50 (ml) needle selection which has been configured to enable automatic recognition of syringe size.

AKD PRODUCT



ENDO EI.IP Infusion Pump

Numerical keypad Easy and fast way to setup. Various displays FND displays numerical data clearly and Color LCD displays detail information. User friendly Simple setup process makes user feels comfortable and variety display gives complete information.

AKD PRODUCT



ENDO EI.IP3 Infusion Pump

Supported by a 5.0" touchscreen display screen, resolution 480x320. Adjustable brightness levels from 1-10. Infusion mode: rate, time, VTBI, BW, intermittent, loading dose, sequence, trapezia, drip with a flow rate of 0.10-1600 ml/hour and preset volume (VTBI) 0.9999.99 ml.

AKD PRODUCT



ENDO EI.HM

Holter ECG Monitor

ENDO EI.HM Holter Recorder is designed with low power consumption, which enables it to record as long as 8 days with a single piece of Li-ion battery. The top toolbar brings access to different function modules. It can be customized by users based on their preference.

AKD PRODUCT



ENDO EI.HM12CH

Holter ECG Monitor 12 Channel

Practical and Lightweight Design. Supported by Micro SD Card storage memory, ENDO EI.HM12Ch weighs 50 grams which is easy to carry anywhere without disturbing the patient's daily activities. Event Marker. There are practical event markers available, just by pressing the M button it will be saved in the signal recording.

AKD PRODUCT



ENDO EI.VSM

Vital Sign Monitor

Loop Mode special working mode designed for daily cycle creation applications. Monitoring mode continuous patient monitoring with real time data, alarms and current condition history. Spot Mode Live examination applications, such as outpatient, emergency, etc.

AKD PRODUCT



ENDO EI-PM

Patient Monitor

Pacemaker detection and resist electrosurgical interference Defibrillation protection, defibrillation synchronization. The screen with touch screen feature allows intuitive operation by clicking on specific parameters waveforms in real time, standard configuration includes navigation buttons.

AKD PRODUCT



ENDO EI.PM2

Patient Monitor

High resolution color TFT-LCD display. Pacemaker detection. Protection against defibrillation and electrosurgery. Pitch tone (Pulse-tone modulation). Unique iSEAP algorithm specially optimized for arrhythmia patients. Dual mode anti-interference oxygen saturation.

AKD PRODUCT



ENDO EI.PM3

Patient Monitor

Color TFT display, 8 inch, touch screen available. 800 x 600 resolution. Max wave 13 waveforms. Record width 48mm. Line speed (12.5 / 25 / 50) mm/sec. Data Transmission export Ethernet/USB data. Patient care viewer data management. Oscillometric Method. Manual, automatic and continuous modes.

AKD PRODUCT



ENDO EI.PM7

Patient Monitor

Color TFT display, 10.1 inch, touch screen available. 800 x 480 resolution. Max wave 13 waveforms. Cuff pressure measurement range 0 - 300 mmHg. Pressure resolution 1mmHg. Max. Average Error ± 5 mmHg. PR measuring range 40 bpm to 240 bpm. Accuracy of ± 3 bpm or 3.5% whichever is greater. NIBP Oscillometric Method.

AKD PRODUCT



ENDO EI.PM8

Patient Monitor

Color TFT display, 12.1 inch, touch screen available. 800 x 600 resolution. Max wave 13 waveforms. Record width 48mm. Line speed (12.5 / 25 / 50) mm/sec. Patient care viewer data management. MFM-CMS central monitoring system. Measuring range 40 bpm to 240 bpm. Accuracy of ± 3 bpm or 3.5% whichever is greater.

AKD PRODUCT



ENDO EI.USGBW

Ultrasound Diagnostic System

Applications : Abdomen,OB/GYN,Vascular, Small parts (breast, testicles, thyroid),Musculoskeletal Conventional & Superficial, Pediatric, Basic Cardiac. Image,SRA,Compound imaging,THI. Display Modes B, B/B, 48, M, B/M,PW. Gray Scale 256 Levels. Scanning Depth 240mm Max.

AKD PRODUCT



ENDO EI.USGBW.1

Ultrasound Diagnostic System

Applications : Stomach, OB / Gynecology, Cardiology, Peripheral blood vessels, Musculoskeletal, Transvaginal, Lungs, Transrectal. Size : $\pm 378 \times 352 \times 114$ mm. Weight: 6.5 kg (with normal battery). 15.6 inch medical high resolution monitor. Resolution : 1920 x 1080. Probe Port: 1 (2 for optional).

AKD PRODUCT



ENDO EI.USGCD.2

USG Color Doppler

Applications : Stomach, OB / Gynecology, Cardiology, Peripheral blood vessels, Musculoskeletal, Transvaginal, Lungs, Transrectal. B, M, Anatomy and color M, CFM, PW, PDI/DPDI, CW, TDI (with PW/M). Size : $\pm 378 \times 352 \times 114$ mm. Weight: 6.5 kg (with normal battery). 7 kg (with large capacity battery)

AKD PRODUCT



ENDO EI.USG4D.v2

4D Digital Color Ultrasound Diagnostic System

Image Mode: Ovary, 2B Mode (Ovarium, Mode 2B). Fetal Face, Virtual HD (Wajah Janin, Virtual HD), Hepatic Vein, PIP Zoom. Fetus, B/BC Mode, Early Pregnancy, C Mode. Lymph Node Enlargement, B Mode. Testicle, CPA Mode, Carotid Vessel, C Mode. 9 inch LED monitor.

AKD PRODUCT



ENDO EI.USG4D.v3

4D Digital Ultrasound Diagnostic System

Image Mode: Modes B, B/M, M, 2B, 4B, CFM, 2D Steer, PD, DPD, PW, B/BC, Triplex, Quadplex, CW, Free Steering M, TDI, Color M, Curved Panoramic Imaging, Trapezoidal imaging, Compound, SRA, Elastography, ECG, Super needle, 4D, Virtual HD, FHI, AIO.

AKD PRODUCT



ENDO EI.USG4D.v7

4D Digital Color Ultrasound Diagnostic System

Image Mode: Mode B, B/M, M, 2B, 4B, CFM, 2D Steer, PD, DPD, PW, B/BC, Triplex, Quadplex, CW, Free Steering M, TDI, Color M, Curved Panoramic Imaging, Trapezoidal imaging, Compound, SRA, Elastography, Stress Echo, ECG, Super needle, 4D, Virtual HD, FHI, AIO.

AKD PRODUCT



ENDO EI.USG4D+EC.20

4D Ultrasound and Echocardiography

Abdominal and pelvic OB / Gynecology Cardiology and peripheral vessels Musculoskeletal Transvaginal and transrectal Lungs. Picture Mode : B, THI/PHI, M, anatomy and color M, CFM, PDI/DPDI, PW, CW, 3D/4D, TDI (with PW/M). Probe ports: 5, 4 active, 1 passive.

AKD PRODUCT



ENDO EI.PWS

Patient Warming System

Alarm : Power failure alarm, Over temperature alarm, sensor failure alarm, temperature variation alarm, system failure alarm. All alarm signals are medium priority. Sound pressure level of auditory alarm signal not less than 65 dB(A) while the distance is 3 meters from the device.

AKD PRODUCT



ENDO EI.TM

Non-contact Infrared Thermometer

Safe and hygienic no touch (1-3 cm distance). Multifunctional, can be used to measure body temperature and objects / objects. Can store up to 20 data. Screen : HD LCD. Measuring range & accuracy. Forehead mode & object mode

AKD PRODUCT



ENDO EI.FM

Fetal Monitor

Convenient to Carry or Transport. Compact, portable and lightweight. Long life Li-ion battery for outpatient service. Easy to Read & Operate. 5.6" foldable screen. Large numeric and waveform display. Simple workflow with silicone buttons for operations.

AKD PRODUCT



ENDO EI.VD

Vascular Doppler

Vascular Doppler has been widely used as standard equipment for peripheral vascular diagnosis. Versatile, modern and portable design allows for quick and simple yet effective arterial diagnosis. Easy to use. Supports 1.5V AA . battery. Modern and trendy design.

AKD PRODUCT



ENDO EI.FD

Fetal Doppler

Ultrasonic Pocket Doppler can meet the routine examination requirements of obstetricians and midwives. Easy-to-use fetal doppler. Fetal doppler with compact design. Interchangeable fetal doppler probe. Built-in audio recorder. Long time continuously use (4 hours) Automatic power-off

AKD PRODUCT



ENDO EI.BPM

Blood Pressure Monitor

Measuring method Oscillometric method
 Ventilation method Automatic ventilation by a micro controller.
 Pressure detection Semiconductor strain gauge. Display LCD or FND.
 Measurement Range Input: 30 to 300 mmHg. Minimum Measurement Unit. Belt driving by a micro controller

AKD PRODUCT



ENDO EI.BPM2

Automatic Blood Pressure Monitor

It is a digital tensiometer that measures blood pressure and heart rate on the upper arm. Equipped with interesting features, one of which is with intellisense technology that guarantees accurate, fast and comfortable blood pressure measurements.

AKD PRODUCT



ENDO EI.VC

Video Colposcope

Cold lighting system of LEDs produces true-to-life network images. Fast and advanced auto focus system ensures clear images. Remote capture control and keyboard layout/design for easy operation. Capturing the right and true pictures. Analyzing colposcopy findings.

AKD PRODUCT



ENDO EI.Neb02

Nebulizer

Power source AC230V, 50Hz. Rated power $\leq 140VA$. Air flow 10-12L/min. Noise $\leq 65dB(A)$. Spray rate $\geq 0.15ml/min$. Container capacity 2-8ml. Drug residue $\leq 1ml$. Size 266(L)x183(W)x128mm(H)

AKD PRODUCT



ENDO EI.SC3
Suction Pump

Single piston cylinder that does not require daily lubrication/maintenance, does not produce pollution to the environment. Good flow, vacuum & performance. The vacuum can be adjusted by the regulator as needed and displayed by the vacuum gauge.

AKD PRODUCT



ENDO EI.SC7
Suction Pump

Maintenance free, oilless pump and high flow rate. Large diameter storage bottle, stopper with sealing ring, easy to open, tighten and clean. The overflow protection device prevents liquid from entering the inner pipe. Transparent non-toxic PVC hose, easy to use observation.

AKD PRODUCT



ENDO EI.SC8
Suction Pump

Dimensions : 345 x 250 x 305 mm. Net weight : 6 kg. Motor speed : 1400 rpm. Vacuum range : 0-600/620 mmHg. Outputs : 20 L/mnt. Bottle capacity : 1Liter. Power consumption : 60W. Voltage : 230V, 50/60Hz

AKD PRODUCT



ENDO EI.SC10
Suction Pump

Dimensions : 485 x 650 x 985 mm. Net weight : 30 kg. Motor speed : 1400 rpm. Vacuum range : 0-680/710 mmHg. Bottle capacity : 2 ltr, 3 ltr, 5 ltr. Power consumption : 0.145 kW. Voltage : 230V, 50/60Hz

AKD PRODUCT



ENDO EI.CA
Chemistry Analyzer

EI.CA is the smallest and most integrated chemistry analyzer, which is perfect for low-volume laboratories. It optimizes the use of space in the laboratory by providing full functionality in small space-Standardized operation, which is consistent with larger analyzers, eliminates manual errors and makes test results more reliable.

AKD PRODUCT



ENDO EI.CA2
Chemistry Analyzer

Wavelength (Wavelength) : 340, 380, 405, 505, 546, 578, 620 (nm) and one free position. Light sources : Halogen lamp, 6V 10W. Appearance : 5 inch touchscreen. Memory : 15,000 storage results. Aspiration volume : 100~5000 µL. Test method : End Point, Fixed time, Kinetics, SUB, DIV, ABS

AKD PRODUCT



ENDO EI.HA
Hematology Analyzer

Test Principles : Impedance for cell counting and cyanide-free methods for HGB. Inputs : 8inch touch screen, keyboard, mouse. Outputs : Internal printer, can be connected to an external printer. Paper Printers : 80 x 35 (mm). Storage : 100.000. Dimensions : 410 x 435 x 472 (mm)

AKD PRODUCT



ENDO EI.CF
Mini Centrifuge

Motor type: DC motor, Rotor capacity: 8 x 1.5/2.0ml tube rotor & 2-place PCR strip rotor, Speed: 6000 RPM 2000 x 4 (MAX RCF), Speed accuracy: ±5% RPM, Size: 162 x 157 x 116mm, Weight: 1.1kg, Air temperature: 37.1°C ~ 38°C

AKD PRODUCT



ENDO EI.CF2
High Speed Centrifuge

Motor type: Brushless DC motor, Max volume: 12 x 2ml (microtubes), Speed adjustment: 500 to 15000 RPM, Max RCF: 15596xg, Speed accuracy: ±100rpm, Working time: 1 to 99 minutes & infinite mode, Acceleration time: 60≤60sec, Deceleration time: 50≤50sec, Size: 190 x 120 x 270mm, Weight: About 2,450kg (with rotor).

AKD PRODUCT



ENDO EI.CF3
High Speed Refrigerated Centrifuge

Motor type: Brushless DC Motor, Rotor capacity: 24x1.5/2ml tube (optional), 44x1.5/2ml tube (optional), 8x4x0.1/0.2ml PCR tube/strip 8x5ml tube (optional), Speed adjustment: 500 to 15000 RPM 22388 x 4 (Max RCF)*, Speed accuracy: ±100rpm, Temperature accuracy: ±1°C

AKD PRODUCT



ENDO EI.ESU
Electrosurgical Unit

Rated voltage: AC120V / AC230V, Frequency: 50Hz / 60Hz, Power consumption: 1200VA + 10%, Carrier frequency: 400kHz, 500kHz, Repetition frequency: 33kHz, Size: 330 x 455 x 150mm, Weight: 13Kg

AKD PRODUCT



ENDO EI.ESU2
Electrosurgical Unit

Rated voltage: AC120V / AC230V, Frequency: 50Hz / 60Hz, Power consumption: 1200VA + 10%, Carrier frequency: 400kHz, 500kHz, Repetition frequency: 33kHz, Size: 390x410x160mm, Weight: 12,5Kg

AKD PRODUCT



ENDO EI.ESU8
Electrosurgical Unit

Voltage rating: 100-240V~, Frequency: 50Hz / 60Hz, Power consumption: 800VA, Frequency: 333~727kHz, Repetition frequency: 23~33kHz, Size: 390x395x160mm, Weight: 11 kg

AKD PRODUCT



ENDO EI.BI
Baby Incubator

Power supply: AC110/220V 60/50Hz Power input: 650 VA, Mattress size: 65x37 cm Trough capacity: 1000 mL, Temperature: 20~30°, Relative humidity: 30~75% Air flow velocity: <0.3 m/s, Temperature fluctuation: +/- 5°C, Noise level <55dB (A) Tilt angle: +/- 12°, Mattress size: 65x37 cm

AKD PRODUCT



ENDO EI.IRW
Infant Radiant Warmer

Power supply : AC220V 60/50Hz Power input : 1000VA, Temperature : 18~30°C, Relative humidity : 30~75% Air flow velocity : <0.3m/s Atmospheric pressure : 700~1060hpa Temperature control range : 32~38°C Temperature sensor accuracy : +/- 0.3°C Temperature uniformity : <2°C

AKD PRODUCT



ENDO EI.BI2
Baby Incubator

Power supply: AC110/220V 60/50Hz Power input: 650 VA Temperature: 20~30°, Relative humidity: 30~75% Air flow velocity: <0.3 m/s Mattress temperature uniformity <0.8°C Temperature control range: 32-37°C Temperature sensor accuracy: +/- 0.2°C Temperature fluctuation: +/- 0.5°C

AKD PRODUCT

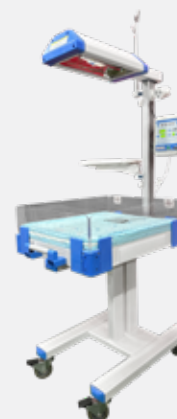

ENDO EI.IRW2
Infant Radiant Warmer

Power supply: AC110/220V 60/50Hz Power input: 900VA, Temperature: 18~30°C, Relative humidity: 30~75% Air flow velocity: <0.3m/s Atmospheric pressure: 700~1060hpa Temperature control range: 32~38°C Temperature sensor accuracy: +/- 0.3°C

AKD PRODUCT



ENDO EI.BI3
Baby Incubator

Input voltage: 110-120, 220-240V Input frequency: 50/60 Hz, Input current: 10A, Power cable: 5m, Size: 1130x650x1350 mm Weight: 83 kg, Fuse: T10AL/250V, Color touch screen, High brightness 8.0 " Resolution: 800x600, Display information: parameters 2200mAh lithium ion battery Battery charging time: 2 hours

AKD PRODUCT



ENDO EI.IRW3
Infant Radiant Warmer

Dimensions: 1190x640x1800 mm Net weight: 115 kg Display: 10.4" color touch screen Resolution: 800x600, Rechargeable lithium battery, Battery charging time: <12 hours Voltage input: 220-240V, Frequency input: 50/60Hz, Current input: 5.0-5.1A (220-240V)

AKD PRODUCT



ENDO EI.OL

LED Operating Lamp

Illumination at 1 m(lux) ≥ 30000 , Color rendering index(Ra) $\geq 85\%$, Color temperature(K), 4500 ± 500 , Tilt left and right 180° , Tilt front and back 180° , Height Adjustment distance(mm) ≥ 400 , Input power (VA) $20\pm 10\%$

AKD PRODUCT

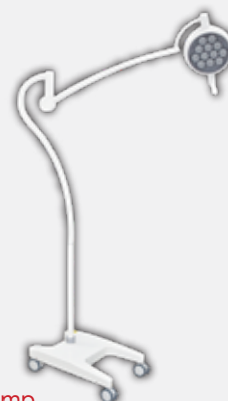

ENDO EI.OL2

LED Operating Lamp

Illumination at 1 m(lux) ≥ 60000 , Optional color temperature(K) 4500 ± 500 , Color temperature(K) 4500 ± 500 , Input power(VA) 20, Color rendering index(Ra), $100\geq Ra\geq 85$, Tilt left and right 160°

AKD PRODUCT

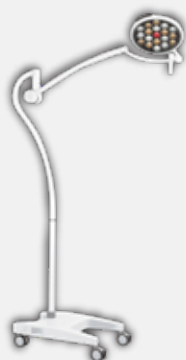

ENDO EI.OL3

LED Operating Lamp

Illumination at 1 m(lux) ≥ 30000 , Color rendering index(Ra), $\geq 85\%$ Color temperature(K), 4500 ± 500 , Tilt left and right 80° , Tilt front and back 180° , Height Adjustment distance(mm) ≥ 400 , Input power(VA), $20\pm 10\%$

AKD PRODUCT

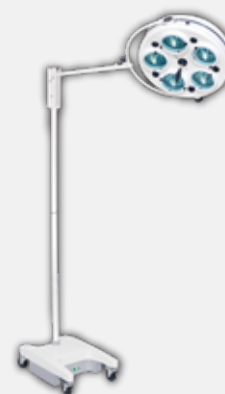

ENDO EI.OL7

LED Operating Lamp

Illumination at 1 m(lux) 80000, Optional color temperature(K) 4000 ± 500 , Color rendering index(Ra), $100\geq Ra\geq 85$, Depth of light beam(cm) ≥ 500 , The value of total irradiance $< 6\text{mW/m}^2\text{lx}$, Total irradiance (Temperature rise on the head of patient under surgical operation $\leq 2^\circ\text{C}$)

AKD PRODUCT

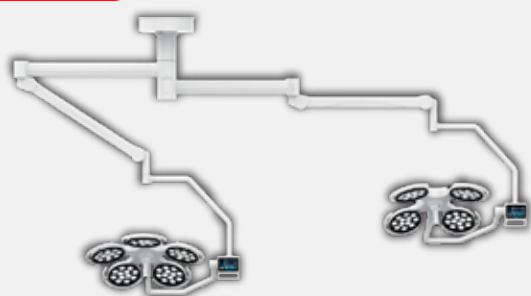

ENDO EI.OL8

LED Operating Lamp

Power supply : 100-240 VAC Frequency : 50-60 Hz Lamp head power : LED 4 lamps 48W, dia. 740mm, 15kg LED 5 lamps 60W, dia. 770mm, 17kg Center lighting: 120klx & 160klx Light field dia. : 220-320mm Light field depth : 600mm Color

AKD PRODUCT



ENDO EI.HL.2

Examination Headlamp

Light source : Single LED, LED power : 5W, Illuminasi : 55000-65000 lux, Work distance : 200-500mm, Light spot : Variable dari D=45mm hingga D=110mm, Power supply : AC 90-240V/DC5V, Baterai : Single (Standard), Dual (Optional).

AKD PRODUCT



ENDO EI.EL2

LED Cold Light Examination Lamp

Balanced spring-loaded articulating arm. Low center of gravity for optimum stability and reach. Automatic switchover from mains to battery in case of power failure. With battery status indicator. Removable autoclave handle

AKD PRODUCT



ENDO EI.EL

LED Examination Lamp Ei.EL

Voltage AC 220V, 50/60Hz, Lamp power: 3.3V/3W, Color temperature: 4800±200K, Usage period: 20000 hours, Illumination: 30000lux 0.5m/10000lux 1m, Lamp head diameter: 55mm

AKD PRODUCT



ENDO EI.EL3

LED Examination Lamp Ei.EL

Color temperature: 4800±200K, Illumination: ≥20,000lx 0.5m, Power supply: AC 220V±22V, 50Hz±1Hz, Power consumption: ≤8W, Lamp bulb: Super bright LED luminotron 3.2V/1W×7, Spot diameter: 120mm, Lighting range: 300~500mm from lamp adapter

AKD PRODUCT



ENDO EI.EL7

LED Examination Lamp Ei.EL

Input power: 10VA, LED bulb power: 12V / 12W, Power voltage: AC220V, Power frequency: 50/60Hz, Lighting level: ≥40000lx 0.5 m ≥ 26000lx 1m, Color temperature: 6000K ± 500K, Spot diameter: 80 – 150 mm

AKD PRODUCT



ENDO Modular Operating Theatre (MOT)

An operating theatre is the key facility within a hospital where surgical operations are carried out in an aseptic environment. Efficient and safe air purification system ensures the aseptic environment of operating theatre for the surgeries of organ transplantation, heart, blood vessel, artificial joint replacement and others.



ECG Bulb Electrode & ECG Limb

Clamp Electrode

ECG bulb and limb clamp electrode, reusable praecordial electrode for ECG. Ball material plastic. Reusable peripheral clamp electrodes for ECG. Electrode material coating Argento Chlorurato. Connection universal screw 4mm and clip.



Micropipette Tip

Accessories

Micropipette is a device used to move liquids in small quantities accurately. Compatible : Eppendorf blue, white and yellow tips.



Patient Cable Compatible

Patient cable compatible for Burdick, Fukuda Denshi, Kenz, Nihon Kohden, Schiller, Cardioline, GE-Marquette, Mortara, Philips/HP, Quinton.



ENDO EI.MP

Micropipette

A micropipette is a laboratory tool used to collect and/or transfer small (micro) amounts of liquid accurately. Usually used to move fluids with volumes < 1000 microliters. Micropipettes (micropipettes) are also often called automatic pipettes.



ENDO EI.Smart

Micropipette

Light and smooth plunger action. Locking mechanism prevents accidental volume changes during pipeting. Bigger digits. The slim design allows the pipette to operate even with the narrow tubes used in Soft touch tip ejection laboratories.



ENDO EI.MMS

Multichannel Micropipette Smart

Leak-free tip loading and ejection with gentle force. Easily removable and fully autoclavable manifold. One-handed tip ejection. Flexibility in operating the pipette without twisting the wrist.



ENDO CS64
CT SCAN 64

Multiple cutting-edge and high-end technologies are integrated to bring unprecedented clinical experience to customers with ultra high efficiency. Two hardware configurations enable flexible selection to satisfy various budgets. Powerful hardware platform optimizes patient throughput, increases work efficiency.



ENDO EI.CS128
CT SCAN 128

Provide 128-slice CT of 76cm large aperture to customers, and improve the resolution of image to 21Lp/cm, help precise diagnosis and treatment of diseases, and greatly improve the clinical performance and extensibility of the equipment.



ENDO MM1
Mammography

Stand-alone Design, more elegant. Outstanding center such as rotating invention patent technology, fast and comfortable. Six operational panel on both sides of equipment, more convenient. Arc style design and multilevel flexibly smart compression, more comfort.



ENDO MM2+Tomo
Mammography

Elegant design, humanized design. HD Low Dose, innovative technology. Four-screen sincronization, every thing under control. Efficiency and practical acquisition and viewing workstation. More excellent imaging performance.



ENDO DRS
Digital Radiography System

Incredibly easy to move, and simple to operate, ENDO DRS is ideal for various radiography applications. High flexibility through the use combined with high-quality images at 5.6 kW output allows you to get quick and dependable X-ray imaging anywhere you need it.



ENDO DRS2
Digital Radiography System

ENDO DRS2 is an all-around and affordable mobile X-ray system, that meets the needs of various medical situations. Highly intergrated and compact design make the device lighter and smarter, and a high-performance imaging system ensures imaging is faster and clearer. It offers you exceptional quality and operation

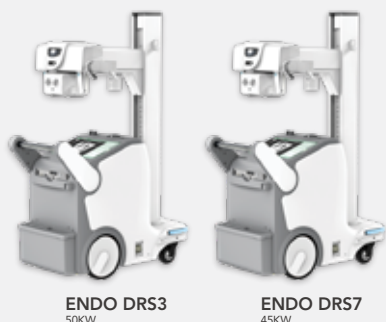

ENDO DRS3 & DRS7
Digital Radiography System

Utilizing cutting-edge technology, ENDO DRS3 & DRS7 always guarantees optimum stability and robustness in radiography. It makes agile maneuverability available in any clinical scene, while its reliable performance with superior image quality remarkably improves diagnostic effectiveness and confidence.



ENDO DRS8
Digital Radiography System

ENDO DRS8 makes continuous innovations on critical details that deliver excellent mobility, smooth workflow, and premium digital images. ENDO DRS8 can effortlessly travel to every point of care from radiology to orthopedics, imaging center, ER, ICU, NICU, etc.



ENDO MDR
Mobile Digital Radiography System

ENDO MDR uses lightweight materials, the weight of the whole machine is less than 150KG, innovative mechanical design, light and flexible to move; dislocation brake system, safe and reliable braking. Equipped with large size, low energy consumption, portable mobile wireless flat panel detector.



ENDO MDR2
Mobile Digital Radiography System

High quality portable FPD, outstanding acquisition conversion performance, the sharp clinical image can be guaranteed. It can realize digital radiography of all human body parts friendly, like head, limbs, chest, spine lumber and so on.



ENDO MDR3
Mobile Digital Radiography System

Mobile, accurate and versatile. Enhanced image clarity delivers diagnosis precision. Control dose, boost quality. High power supply meets all clinical demands. Compact, flexible and easy positioning. Humanized design and intelligent control mode.



ENDO C-Arm
High Frequency Mobile C-arm System

Pulse control, Digital radiography, Auto fluoroscopy. Attractive design, Compact appearance More details, Less dose. Flexible C-arm Design. Digital mega pixels image system. High frequency high voltage x-ray generator and high precision digital pulse control technology ensure excellent image with low skin dose.

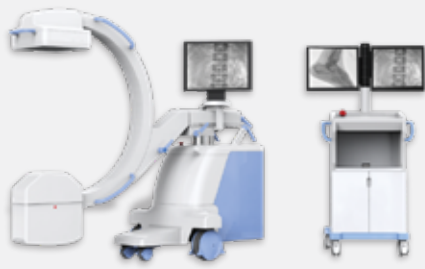

ENDO C-Arm2
Mobile Digital FPD C-arm System

Advanced digital with image humanized technology design, Lower dose Sharper image, Faster positioning Higher efficiency Free rotation without dead space. 360° horizontal movement to satisfy complex positioning Unique design of electric auxiliary support arm make the movement of machine more stable.



ENDO DRX
Digital Radiographic X-ray Equipment

Large size touch user interface Easy exposure control. Smooth positioning at complex angle for radiography. Rich options for clinical application. High efficient image system delivers effortless interaction. Floor-mounted tube support and fixed table. Flexible X ray tube movement. 4-way, floating bucky table



ENDO EI.XRV
X-Ray Film Viewer

Optical parameter: No flicker on the screen, brightness in the center of the screen is about 4000cd/m². Screen light dispersion coefficient > 0.8. The screen is evenly illuminated with a uniformity coefficient of ≥0.8. Light source color temperature: 12000K.



ENDO EI.XRV2
X-Ray Film Viewer

Optical parameters: No flicker on the screen, brightness in the center of the screen is about 4000cd/m² Screen light dispersion coefficient > 0.8 The screen is evenly illuminated with a uniformity coefficient ≥ 0.8 Light source color temperature: 12000K



ENDO Front Protection Apron RA660 & RA650
Radiation Protective Clothing

Our RA660 range offers up-to-date radiation protection clothing which accompanies your active working day and provides outstanding service Front protection in its pure form. Model RA650 offers full-body protection over the entire front section covering the required 60% of the girth.



ENDO Thyroid & Sternum Protection RA614
Radiation Protective Clothing

With Different Closures. Hook-and-loop fastener (RA614KL). Standard size fits neck sizes of 32 - 45 cm. Magnetic closure (RA614MA) Standard size fits neck sizes of 32 - 45 cm. Exchangeable hook-and-loop fastener (RA614AK). Standard size fits neck sizes of 37 - 50 cm.

AKD PRODUCT

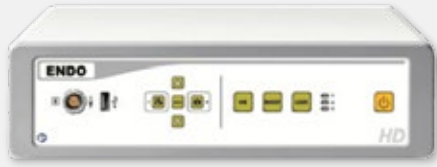

ENDO EI.EC7

Full HD Camera System

Full HD Display Resolution. High Speed Shutter. Multi-language Menu. Remote camera remote. Dimensions (WxHxD). Control : 353 x 103 x 252mm. Camera Head : 34 x 73mm. TV Resolution 1920 x 1080 Px (Full HD). Index Ratio 54 db

AKD PRODUCT



ENDO EI.LS2

Light Source

Main Voltage 100-240 VAC. Power Consumption 130 VA. Current Consumption 1.1 A. Frequency 50/60 Hz. Tool Dimensions (WxHxD) 360 x 125 x 251 mm. Accessories cyber optic cable, power cable, manual book. Video-In Terminal 1x video, BNC

AKD PRODUCT



ENDO EI.EC8

Endoscopy Camera

White balance: automatic. AGC (Automatic Gain Control): On / Off. Brightness adjustment: level 0 - level 9. Edge enhancement: level 0 - level 9. Contrast enhancement: low, medium, high. Photometry modes: full, wide, circular. Max. video resolution $\geq 1920 \times 1080$

AKD PRODUCT



ENDO EI.LS8

Light Source

Uniformity of illumination : Termiur value less than 1.05 times the nominal value. Points outside the illumination threshold: ≤ 2 . Maximum noise: ≤ 55 dB. Light intensity level : 1-19. Total length : 3000 mm, allowance: $\pm 5\%$. Light input surface dimensions: Diameter: 5.4 mm Length: 62.0 mm.

AKD PRODUCT



ENDO EI.EC9

Endoscopy Rigid Camera

Video resolution: ultra high definition video signal (HDMI, Quad SDI) : 3840 x 2160 high definition video signal (DVI, HD-SDI) : 1920 x 1080. Brightness adjustment: level 0 - level 9. Edge enhancement : level 0 - level 9. Contrast enhancement: low, medium, high. Photometry modes: full, wide, circular.

AKD PRODUCT



ENDO EI.LS9

Light Source

Endoscope port: Apply to video endoscope with 059.5 mm connector or connector. White Light mode (WL Mode) : Infrared ray cutting performance: In the wavelength range between 300 nm and 1700 nm, the ratio of radiation flux to light flux should not be greater than 6 mW/lm.

AKD PRODUCT



ENDO EI.EC11

Camera System All-In-One

Portable laptop size unit instead of the traditional heavy endoscope tower. Convenient for mobile medical treatment and clinical examination, e.g. in doctors office, outpatient setting and day clinics. Full HD camera head for use with rigid and flexible fiber endoscopes.

AKD PRODUCT



ENDO EC-1

Portable Camera System

Camera 1/3 inch CCD waterproof camera. Scanning standard DVI output 600 lines. Output Video. Light source LED lamp. Light source color temperature 6000K. Storage SD card dynamic / static storage. Display screen 15 inch TFT color screen.

AKD PRODUCT



EI. USBPC1

CCD USB Portable Camera

Product weight 4000 g. Waterproof camera head. Product size 18.3 x 4.8 x 11.6 cm. Frequency 50/60 Hz. Input 110 - 230 VAC 35 VA. Analog video output. Minimum lighting 3 Lux. Automatic white balance. Image sensor is 1/3 CCD sensor. High quality videos.

AKD PRODUCT



EI. USBPC2

Full HD USB Portable Camera

Product weight 4000 g. Waterproof camera head. Product size 18.3 x 4.8 x 11.6 cm. Frequency 50/60 Hz. Input 110 - 230 VAC 35 VA. Analog video output. Minimum lighting 3 Lux. Automatic white balance. Image sensor is 1/3 CCD sensor. High quality videos.

AKD PRODUCT



ENDO EI.Pump

Pump for Colonoscopy & Gastroscopy

Water flow Maximum 4.0 Lpm. Resource 220V - 230V AC. Power 55VA. Pressure Maximum 0.6 Mpa Frequency 50/60 Hz. Classification Class I, IP 20. Dimensions (LxWxH) 21.5 x 30.5 x 12.5 cm. Weight 4 kg

AKD PRODUCT



ENDO EI.Lap.Pump

Pump

Intelligent leak compensation for optimal display of fluid balance. Non-contact pressure measurement. Easy to operate. Permanent patient monitoring. Quick start time and easy loading tube sets. Precise pressure control and regulation. Small learning curve for surgeons and nurses LCD

AKD PRODUCT



ENDO EI.Lap.INS2

Insufflator with Heater

Storage and Transport Environment -40 degrees to +70 degrees centigrade ambient temperature. Operating Environment ambient temperature 10 degrees - 40 degrees and 30%-70% relative humidity. Minimum Pressure Display 0.5mmHg. Resource 100-240 VAC. Frequency 50 Hz.

AKD PRODUCT



ENDO EI.Lap.INS3

CO2 Insufflator with Heater

Inflation Pressure : 1-30 (max 65) mmHg. Pressure Measurement Accuracy : +/- 5%. Gas Flow : 1-xx liter.min. Gas Flow Display. Accuracy : +/- 10%. Insufflation Gas : Medical carbon dioxide gas CO2 /max 80 bar. Gas Connection : UNF 7/16. Dimensions : 355 x 105 x 285 mm

AKD PRODUCT



ENDO EI.Lap.MC

Morcellator System

Electronically controlled morcellator with digital speed indicator, rotation speed and torque control. Retractable cutting blade ensures high level of operating safety. Ergonomic and simple operation.

AKD PRODUCT



ENDO EI.Lap.MC2

Morcellator System

Used for minimally invasive procedures such as removing the uterus. Morphation refers to the division of tissue into smaller pieces or fragments and is often used during surgery to remove small incision tissue.



CO2 Insufflator

Insufflator

The start settings for flow and pressure are customized individually. The insufflator has a reliable venting system that safety reduces excess pressure in patients. A replaceable gas filter protects the device from gas supply contamination. Highest safety. Mature technology



Multi-Indication Pump

Four devices in one : Laparoscopy, Arthroscopy, Hysteroscopy, Urology. Resource saving, simple, innovative. The ingenious device combines a streamlined design, easy operation and maximum safety. Key parameters are seen at a glance, allowing for quick and correct actions by personnel.



Pulsar MB350
Electrosurgical Unit (ESU)

Pulsar MB350 provided with all the performance needed for the monopolar or bipolar use in open or laparoscopic surgery. Pulsar MB350 also allows the users to memorize up to 33 programs for all surgical needs and 6 specific programs for the use in saline with mini resectoscopes and bipolar instruments 5 Fr.



Ultrasonic Scalpel System
Scalpel System

Protection pad effectively extend the using time of the scalpel. Precise dissection lateral thermal tissue damage only 1 mm. Multifunction grasping, dissection, cutting, and coagulation, all in one single instrument.



Pneumatic Lithotripsy,
Lithotripter

There are total thirteen choices. Twelve repeat frequency starting 1 per second up to 12 per second. In addition Mono mode is provided to control the trigger precisely. High precision LITHOSPLIT Hand Pieces use matched piston and cylinder to give a long and reliable service life.



digiFLOW - 4
Uroflowmetry System (4W)

DigiFLOW 4 is a compact and Hi-Tech digital Uroflowmetry system designed for practical, everyday flow studies. The device works with any standard PC. The investigation starts automatically when the patient starts voiding. The flow and volume scales can be adjusted.

ENDO



ENDO EI.SB
Rectal Suction Biopsy Tools

Pistol grip designed for better control. Includes vacuum T assembly and positioning capsule. Reusable or designed for multiple uses.

endovision

infinite vision of the medical device



Arthross Plasma RF System RF Console

RF Plasma generator is applicable to all surgery as well ; as all area like Spine, Sports Medicine and ENT. It shows sophisticated signals and diversified levels 1-9 to meet the needs required from each indication. Depending on the target area, level 1 to 9 steps can be a sophisticated operation.



Medical Fluid Pump Fluid Pump

Intended use Arthroscopy, Urology, Hysteroscopy. Pressure range 10 - 150 mmHg 10%. Flow range 0,1 - 1,5 l/min 10%. Power draw 65VA. Supply voltage 100-240 VAC. Power frequency 50/60 Hz. Protection class Class I, type BF. Weight (kg) 7,6kg. Fuses As per Table 7.



Arthroscopic Shaver System Shaver

Wide range of rotational speeds. Window calibration feature. Available direction modes: forward, oscillation, reverse. Nine oscillation modes. Automatic handpiece detection. Controlled directly via buttons on the handpiece or via footswitch. Dedicated shaver blades

ENDO



ENDO Pneumatic and Ultrasound Lithotripter Pneumatic Lithotripter

Cutting edge multi microcompressor design that controls the ultrasonic energy for maximum power and performance. This intelligent design provides real time feedback that prevents overheating of the ultrasonic handpiece and probe that is common with other lithotripters.

blue endo international



Blueendo Morcellator Morcellator

Speed: 100-800 RPM. Maximum torque: 1,5 Nm. Cutter diameters: 12,5, 15 and 20 m. Temperature: 10 to 60 °C. Relative humidity: max. 90%. Air pressure: 700 to 1060 hPa. Operating and control unit. Weight: 6.5 kg. Degree of protection against flammable gases.

Sinolinks



Polymer Ligating Clips Ligating Clips

Used for human body blood vessels and coelom organization ligation and closing during operation. Safe polymer materials, good biological compatibility. No affecting on X-ray, CT, MRI, and other imaging studies. Safety lock, arc, elasticity, and prevent slippery designs.

Sinolinks



Polymer Ligating Clips Applier Ligating Clips

Precising Pinch, Non nod version, enhanced material for applier. Rounded corners of the appliers head reduce the risk of broken clips and misalignment

ELMED



Elmed ESWL

Electro Magnetic Shock Wave Lithotripsy

Two types of focusing method of Electro Magnetic System. All modern devices are EM system. Noise level is less. Powerful and high success rate. User friendly. Multimed EM is flat coil system. Movable shock wave head to four position (under table and over table and their oblique positions).

ELMED



Avicenna RoboFlex

Robotic Flexible Ureterorenoscopy

Surgeon perfect position and comfort during operation. Ergonomic & better control of the ureterorenoscopic intrarenal movements that are accurate, precise and fine movements. Less radiation for the surgeons during procedures. Extended life of the ureterorenoscopes.

Potent[®]



Holmium Laser Therapeutic

Laser Therapeutic

High Quality Laser Output Professional designed high stability anti-interference laser power device guarantees strongly for high quality laser output and continuous. Enhanced Targeting The laser is equipped with a green aiming beam which aids in targeting and is easily seen during procedures.

Potent[®]

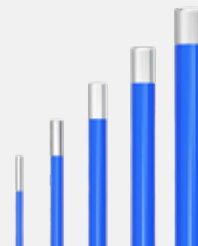

Holmium Laser Therapeutic Fiber

Fiber

Multiple Sizes: 200, 276, 365, 550, 800, and 1000 μm , even smaller sizes. Full Deflection: The 200 micron fiber is highly flexible and soft, boosting surgical efficiency with strong transmission in flexible scopes.

ENDO

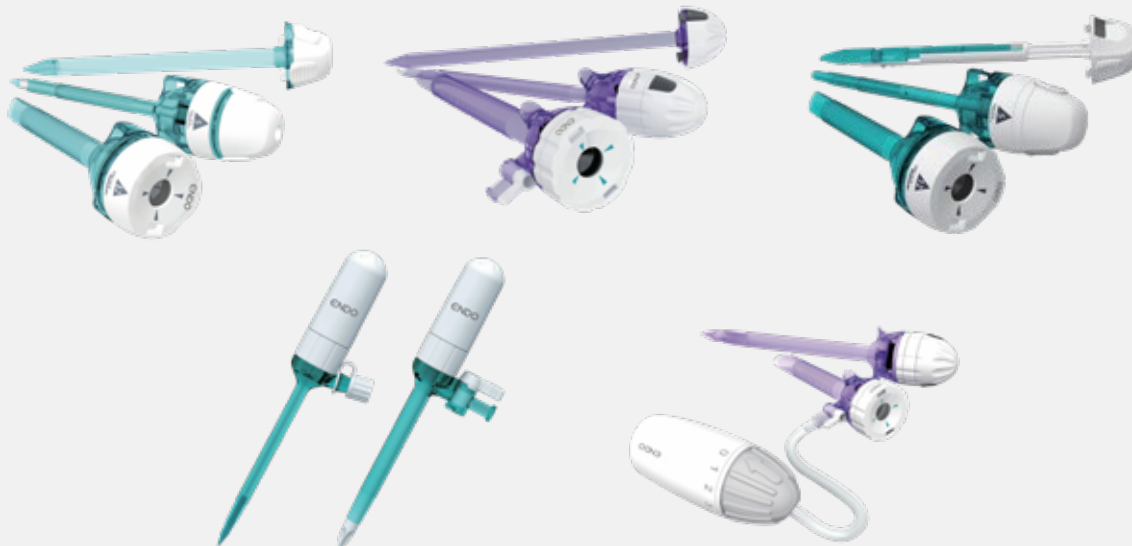

ENDO Single Use Laparoscopic Trocar Kit

Laparoscopic Trocar Kit

Universal Sealing increases trocar insertion resistance without. Threaded Design enables to control puncture speed that avoids damage to abdomen. Pyramid Tip protects inter organs when puncturing. Large aiming tapered surface facilitates one-handed operation and easy insert working channel.

Translucent Design for easier observation of instrument insertion/removal and extraction of specimen. Safety Lock indicates when the blade is shielded and exposed. Simple seal detachment for versatility during specimen removal.

ENDO



Single Use Multiport Single-Incision Laparoscopic Surgery Trocar

Multiport Laparoscopic Surgery Trocar

It is widely used in laparoscopic surgeries such as NOTES, TaTME etc. 3 holes/ 4 holes for different surgeries. 360° rotation prompt flexible operation. Optical easy to observe operation. Optical and rotatable.

Flexible adaption with good sealability. Collocating with Surgaid common trocar or pediatric trocar to supply an operative platform. Meanwhile, the number of holes is selected according to surgical needs to ensure good sealability. Safe and minimally invasive to protect the incision

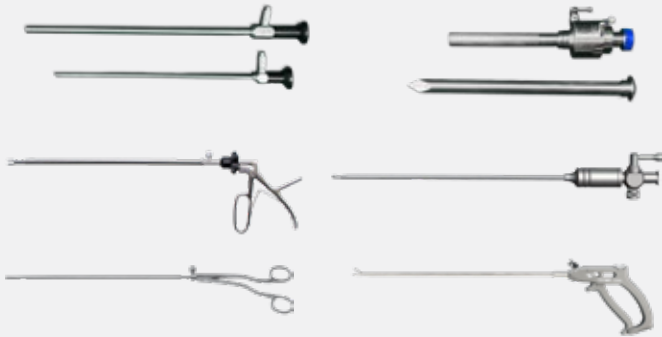

Laproscope Instruments



Urology Instruments



Hysteroscope Instruments

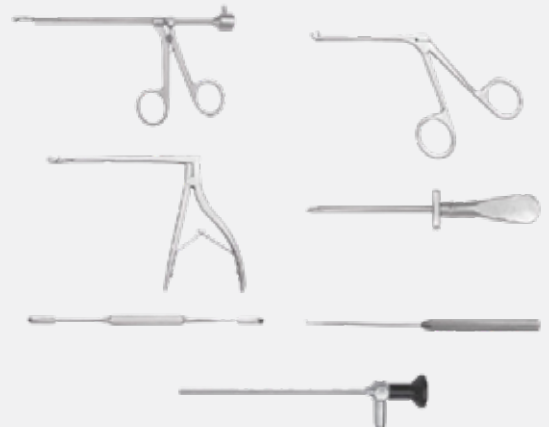

ENT Instruments



Arthroscopy Instruments



Lscope Single-Use

Digital Flexible Ureteroscope 7.5 Fr

Ergonomic handle with easily accessible control elements. Lightweight handle for reduced operating fatigue. Safety atraumatic tapered tip. Extremely smooth, slim and continuously cylindrical sheath for precise working operating comfort.



DIS Image Processor

Support endoscope during minimal invasive, provides power and processes the images for endoscope. Synchronous multi interface output support.



Percutaneous Nephrostomy Set

Set with PTFE Guidewire

Convenient removal, dual knobs allow the sheath to be easily peeled away after insertion is completed. Dilators constructed with firm, kink resistant material. Smooth surface reduces patients trauma.

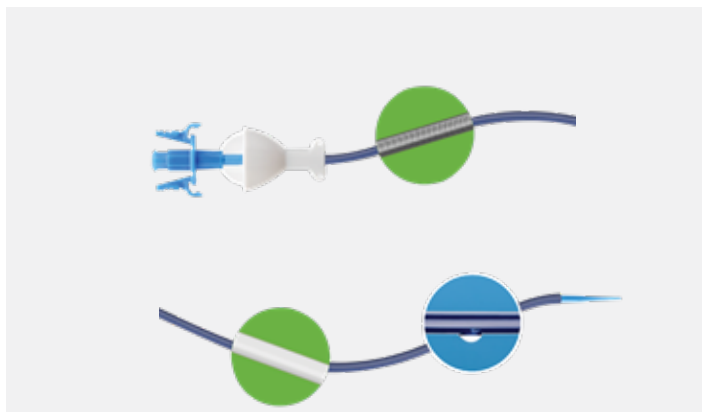

Bendable Ureteral Access Sheath

The sheath provides ureteral dilation and a continuous working channel for the introduction of endoscopes and instruments during ureteral access procedures. Use the sheath to reduce the potential for trauma to the ureter during repeated instrument exchanges.



Ureteral Access Suction Sheath

Urology Consumable

Ergonomically designed for single-handed use and easy control of negative pressure switch by doctors. Easier search and closer to renal calyx. Allowing for free pressure adjustment



Guidewire

Fixed Core Guidewire

PTFE Coating improves handling and offers a smooth wire surface to facilitate advancement and device tracking. Stainless Steel Core wrapped in a flat wire designed to provide balanced performance.



Zebra Guidewire

Zebra Nitinol Core Guidewire

Tungsten-filled radiopaque tip enhances fluoroscopic visualization. Multiple tip options designed to provide the additional tip flexibility for negotiation of narrowed ureters and access beyond obstructions.



Ureteral Stent Set

Urology Consumable

Biocompatible medical material softens up to 50% at body temperature, promoting enhanced comfort and minimal friction. Graduated circumferential markings every 5cm along the body of the stent to confirm advancement and placement.



Ureteral Dilator Set

Urology Consumable

The Ureteral Dilators are used for dilation of the ureter prior to ureteroscopy and stone manipulation. Smooth surface for less trauma and easy advancement

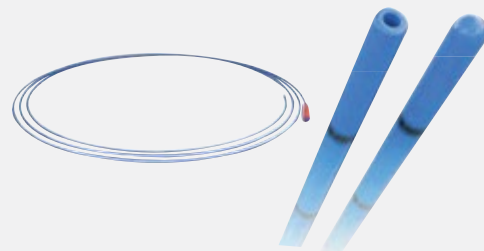

Ureteral Catheter

Urology Consumable

Graduated markers and radiopaque to facilitate visualization and placement. Various sizes and tip configurations for a variety of procedures. Straight tip closed and open, enclosed luer adapter. Tapered tip to provide atraumatic access for delivery of contrast or a guidewire



Nitinol Retrieval Basket

Urology Consumable

Various tips to treat a variety of stone position. High elastic nitinol material Retain its shape following extreme torsion and over multiple deployments.

ENDO



ENDO EI.DFU

Disposable Flexible Video Ureteroscope

Single use flexible video ureterorenoscope delivers high quality image for visual inspection with a clean and safe clinical flow. It's affordable without reprocessing and maintenance, and it benefits both patient and hospital by effectively avoiding cross contamination.

4-way bending facilitates multidimensional observation
Excellent image quality with highly integrated CMOS and LED
3.6Fr working channel ensures good perfusion flow and reduces the risk of surgical infection

SEESHEEN



Video Cystonephroscope & Ureterorenoscope

Flexible Video

Better vision and durability than traditional fiber scopes. Video Chip-on-Tip technology. 275° bending to reach lower calyx. Left & right 120° insertion rotation. Photograph and video recording.



Video Choledochoscope

Flexible Video

Video Chip-on-Tip technology Photograph and video recording
Left & right 120° insertion rotation Video signal output ability to medical grade display.



Video Bronchoscope

Flexible Video

Multi-function Buttons Capture, record, freeze, zoom in/out. Passive Bending 210° up and 130° down with passive bending: smooth bronchial advancement and less mucosal injury Left/Right Rotation ±120° rotation: ease of bronchial orientation and less fatigue



Video Rhinolaryngoscope

Flexible Video

Standard Class I, rule 5 according to annex IX of directive 93/42/EEC. Operating Condition Temperature: 15°C-37°C, atmospheric pressure: 700-1060hPa, Humidity: 30%-85%. Storage Condition Temperature: -47°C-70°C, atmospheric pressure: 700-1060hPa.



Video Intubation Laryngoscope

Flexible Video

Multi-function Buttons Capture, record, freeze, zoom in/out. Detachable Battery. Always ready for use. Portable Type Compatible with portable monitor CV-1080/HV-3101. Handheld Type Compatible with CV-1030 Portable. Compatible with portable monitor CV-1080/HV-3101

AKD PRODUCT



ENDO EI.EC.v3 & ENDO EI.LS.v3

Video Endoscope System & Light Source

The new chromoendoscopy VIST multi-mode is interchangeable at a touch of a button, without any delay you can notice. Maximized optical effect, minimal light loss. A clear vision with Full HD output . Brilliant workflow. One step connection, hot plugging

AKD PRODUCT



ENDO EI.EC.v2 & ENDO EI.LS.v2

Video Endoscope System & Light Source

VIST1 is a chromoendoscopy technology combining optical and digital image processing. Under both White Light and VIST mode, ENDO EI.EC.V2 image processor yields even more details with the 2-LED light source, and no longer sacrifices the brightness in the far field.

AKD PRODUCT



ENDO EI.EC.v7 & ENDO EI.LS.v7

Video Endoscope System & Light Source

Innovation rewrites the standard. With that in mind, ENDO Indonesia presents you the ENDO EI.EC.v7, a brand new high definition endoscopy system designed specifically for screening and diagnosis with an excellent budget friendliness. CMOS, Smart Workflow, Improved scope handle design.

AKD PRODUCT



Bronchoscopy EI.EC.v3

High Definition Video Bronchoscopy System

EB-5T28's large instrument channel renders a better suction, and can accommodate the passage of a wider range of instrument options. EB-5H20 allows you to visualise as deep as the fourth-order into the tracheobronchial tree, reaching a high diagnostic yield.

AKD PRODUCT



Bronchoscopy EI.EC.v2

High Definition Video Bronchoscopy System

Optimized insertion experience. The gradual stiffness makes the insertion experience easier and smoother. Brilliant workflow. Ergonomic scope handle design. Outstanding manoeuvrability. Optimized insertion experience

AKD PRODUCT



Bronchoscopy EI.EC.v7

High Definition Video Bronchoscopy System

EB-500 is an essential scope for physicians' routine clinical practice, featuring a slim diameter and a large angulation. CMOS Smart Workflow. improved scope handle design

AKD PRODUCT



ENDO EI.VL

Portable Video Laryngoscope

Slim Blade, The super slim blade profile improves access in smaller mouth gaps and reduces tooth decay making it safer for patient use. Portable or USB Rechargeable Universal, cord-free device whenever you need it.



ENDO Endoscopic Foreign Body Forceps

Instrument Flexible Endoscopy

This device is combined use with endoscope to extract and remove foreign body in digestive tract. Jaws are made from medical stainless steel with good biocompatibility. The head is carefully polished so that less damage is made to endoscope channel.



ENDO Single Use Cytology Brush

Instrument Flexible Endoscopy

Used to collect cells from the bronchi and/or upper and lower gastrointestinal tracts. PTFE Sheath Designed to help reduce friction, facilitating pass through the scope. Handle has reinforced metal tube for reliable actuation.



ENDO Disposable Endoscopic Cytology Brush

Instrument Flexible Endoscopy

This device is clinically used to brush cell samples. Unibody design of brush and pulling wire ensures that the brush will not fall off. Use imported bristles, which are neither too hard nor too soft, can brush cells easily and sufficiently.



ENDO Single Use Retrieval Net

Instrument Flexible Endoscopy

Used to endoscopic removal of stines and foreign bodies in the GI tract. Function of rotation is designed to accommodate physician technique preference. Nylon material engineered for better supporting strength.

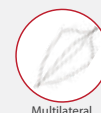

Multilateral

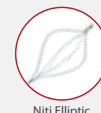

Niti Elliptic



Niti Spiral

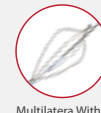

Multilatera With Guidewire

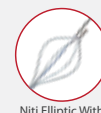

Niti Elliptic With Guidewire

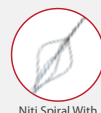

Niti Spiral With Guidewire

ENDO Single Use Stone Retrieval Basket

Instrument Flexible Endoscopy

Used to endoscopic removal of biliary stones and foreign bodies. The metal alloy basket is designed to maintain basket symmetry even after difficult stone manipulation.



Hemoclip

Disposable Endoscopy Instruments

The non-reposition hemoclip is used in conjunction with endoscope, applying in the mechanical hemostasis of non-variceal bleeding and wound suturing in digestive tract.



Polypectomy Snare

Disposable Endoscopy Instruments

The polypectomy snare is a monopolar electrosurgical device used with an electrosurgical unit for endoscopic polypectomy



Biopsy Forceps

Disposable Endoscopy Instruments

The disposable biopsy forceps works with flexible endoscopes, passing through the endoscope channel into the human body cavity to take the living tissues for pathology analysis



Grasping Forceps

Disposable Endoscopy Instruments

The disposable grasping forceps is used in conjunction with the soft endoscopes, entering into the human body cavity such as respiratory tract, esophagus, stomach, intestine and so forth through the endoscope channel.



Stone Retrieval Balloon (Platoid)

Disposable Endoscopy Instruments

The stone retrieval balloon (platoid) is used in conjunction with flexible endoscope to extract the stones on bile duct, which can also provide lumen for inserting guide wire and injecting contrast agent.



Sphincterotome

Disposable Endoscopy Instruments

The sphincterotome knife is mainly intended for resection and coagulation to the duodenal papilla sphincter in the ERCP procedures. It is usually used in conjunction with the guide wire devices.



Sclerotherapy Needle

Disposable Endoscopy Instruments

Clinically, disposable endoscopy injection needle is a medical device that pass the endoscope channel into the alimentary canal or gastrointestinal tract to perform injection to the gastrointestinal mucosa.

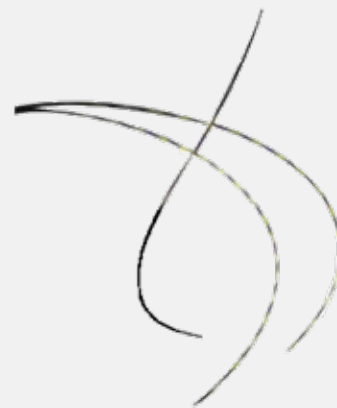

Guide Wire

Disposable Endoscopy Instruments

The guide wire is intended for ERCP diagnosis or therapy when there seems to be various diseases of the digestive system in the pancreatic and biliary duct.



Nasal Biliary Drainage Catheter

Disposable Endoscopy Instruments

Nasal biliary drainage catheter is used for endoscopic gall - stone operation or bile drainage after cholecystectomy.



Stone Extraction Basket

Disposable Endoscopy Instruments

Disposable stone extraction basket (security wire) is used for the endoscopic removal of biliary stones and foreign bodies.

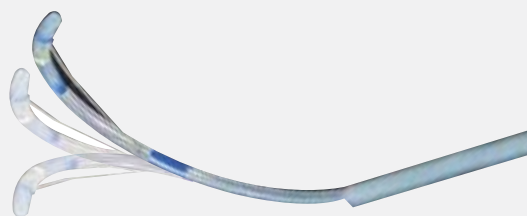

Sphincterotome (Rotatable)

Disposable Endoscopy Instruments

The swing sphincterotome is mainly intended for resection and coagulation to the duodenal papilla sphincter in the ERCP procedures. It is usually used in conjunction with the guide wire devices.

ENDO



ENDO Endoscope Washer

Endoscope Washer

Double Tank System: ENDO Endoscope washer and Disinfector Machine makes the contamination risk lower and the usage of the disinfectants longer. Double Scope Property: ENDO Endoscope washer and Disinfector Machine saves up the time and solution by disinfecting two endoscope at the same time



ENDO OPA

Disinfectant

Ready-to-use. Based on Orthophthalaldehyde (0,55%). Odorless and do not forms harmful gases. Thanks to low toxicity it makes a safe usage on staff. Can be used up to 14 days. Can be controlled by test strips. Be used manually. 5 mins and Cold Sterilization in 5 mins.



ENDO Forte

Disinfectant

Based on Gluteraldehyde (2%). Can be used upto 28 days. Can be used manually. Thanks to not foaming Formula, Detro Forte is suitable for use in Fully Automated Endoscopy Washer and Disinfector Machine. Disinfection in 5 mins and Cold Sterilization in 15 mins. Do not cause corrosion.



ENDO Enzym

Enzymatic

Concentrated product. Effective in 15 minutes at manual usage. Effective cleaning property. Decrease microbic agents by decontaminating organic contaminations. Decrease corrosion risk by decontaminating inorganic contaminations. Effective in 5 minutes at ultrasonic cleaner.



ENDO CLEAN 1000

Endoscope Washer

Maintaining concentration of sterilization liquid for certain period by minimizing dilution rate. A function to prevent draining of sterilization liquid Easy to determine sterilization liquid replacement cycle with counter display of sterilization liquid.



ENDO CLEAN 2000

Endoscope Washer

Dual scope processing. Rapid drying basin and surface of endoscope by strong air shower. Equipped with strong air gun. Equipped with filter. Blocking foreign substance entering endoscope. Strong multiple 3 channel 360 degree rotating nozzle type

GERUI



Disposable Bite Block with rubber headband

Function open the mouth and throat inspection. Material PP
Size L26.5 * W21 * H24.5 mm Strip 550*20 mm

EZLIG



Multi Band Ligator

Post installation of the bands makes the field clear. Precise ligation, obvious release resistance, easy to operate. Multi-bands design achieves to treat several points in one operation. Bands release reminds by feeling and sound.



SHANGXIAN



Disposable Endoscopic Distal Attachments

Disposable Endoscopic

Providing more working space for surgery. Maintaining the good field of viewing of endoscopy procedure. When colonoscopy procedure, it helps to unfold the colon. More positive rate. Be aware of the distance between tissue and endoscope.

ENDO



ENDO Disposable Circumcision Stapler Single Use Sterile Pre-use Stapler System

Replacing traditional circumcision. Increase the density of the staples, Achieve no bleeding surgery. Safe, convenient and economical. Quick threaded design reduces the number of turns and shortens the operation time. Operational manipulation is visual and the incision margin is neat and beautiful.

ENDO



ENDO Open Surgery Instrument Set

- Appendectomy Set
- Bandage Instrument Set
- Embryotomy Set
- Herniotomy Set
- Mastoidectomy Set
- Tonsillectomy Set
- Abdominal Operation Set
- Circumcision Set
- ENT Surgical Set
- Hysterectomy Set
- Mayor Set, Minor Set
- Tracheostomy Set
- Amputation Set
- Craniotomy Set
- Hecting Set
- Laparotomy Set
- Partus Set, IUD Set
- Venous Section Set



Disposable Circular Stapler III

III Rows Series, Circular Stapler

Stronger penetrability. Specification can be known at a glance. Fool-firing position Special design of the outer ring prevent anastomotic tissue from excessive squeezing. B-type staple with slightly incurved feet make the anastomotic a higher tensile strength.



Disposable PPH Stapler III

III Rows Series, PPH Stapler

Anastomotic wound is dry and has no bleeding after firing. No longer need to manually suture absence of special circumstances. The PPH stapler cartridge arrangement is more compact and its outermost surface has a special design. With 48 three-row titanium screws, the tissue can be closed with effect.

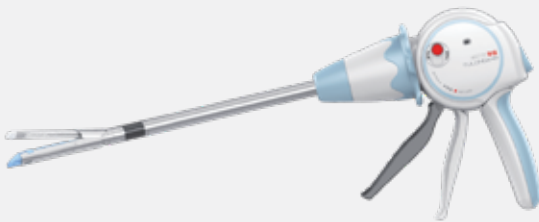

Disposable Endoscopic Cutter Stapler & Cartridge

Applied to tissue transection, resection & anastomosis in thoracic surgery, abdominal surgery and gynecologic endoscopy Adaptive joint head can swing within 90°. The joint moves flexible and can be operated by single hand conveniently. Operation is safer by resetting the button manually.



Disposable Auto Linear Stapler

Waston, III Rows Series, Auto Linear Stapler

II ROWS series of disposable auto linear stapler with cartridges (hereinafter referred to as stapler) is an instrument automatically placing three staggered rows of staples to suture the tissue for intended use. It is simply used to substitute the manual operation.

ENDO



ENDO Shaver System

Arthroscopic Shaver

Full touch LCD screen. Easy-to-use interface, switch work mode effortlessly. Two handpiece ports. Working efficiency. Blades: oscillation speed range 500-3000RPM, forward or reverse speed range 500-5000RPM. Burrs: forward or reverse speed range 6000-12000RPM

ENDO



ENDO Shaver System

Blades and Burrs

Single-use. Blades and burrs available. Different sizes and shapes. Compatible with handpiece from Dyonics & Livantec.

AYGUN[®]

SURGICAL INSTRUMENTS CO., INC.



AYGUN High Speed Motor Neuro System, HSM2

Surgical Instruments

AYGUN HSM-2 system, which combines the innovative technology and aesthetics, highlights the user comfort. High speed, high torque and motor recognition which are the most requested features by surgeons, in combination with ergonomic and light hand tools prevent fatigue even after long hours of surgery.

AYGUN[®]

SURGICAL INSTRUMENTS CO., INC.



AYGUN Scoren Surgical Power System

Surgical Power System

Perforator, Craniotome, Straight, Angular and Curved Attachment options. Higher and precise cutting speed for neurosurgical operations Rosen, Diamond, Tungsten, Acorn, Bud and Neuro Burrs Easy handling & keyless assembly.

iMEDICOM

Intended for Veterinary



EZX Acetabular Cup Removal System

Technology. EZX blades operating in rotational motion cut along the outer surface of the acetabular cup precisely and make accurate results. Patent Registered. New Excellent Technology. Efficient. EZX system offers 29 different sizes of disposable blades. Intended to remove hemisphere, cementless & cemented cups. A singular blade per a procedure.

ZKSK Medical



Disposable Pulse Lavage

Pulse Lavage

Clearer field and easier to operate. Ergonomic design, minimal set up, easy to use. To increase permeability between bone cement and sclerotic. To reduce the dosage of antibiotics and expenses. Pressure up to 15 PSI

AKD PRODUCT



ENDO EI.PT.CD
Cannulated Drill

ENDO power tools handpieces which provide the surgeon with power for the most demanding acetabular reaming procedures. High torque single function power tools. This has been achieved through continual engineering refinements.

AKD PRODUCT



EI.PT.CD V2
Cannulated Drill

ENDO Cannulated Drill (EI.PT.CD.v2) is a medical electric drill consisting of handpiece, battery charger, battery and accessories. The housing/package of the unit is completely enclosed and can be sterilized in an autoclave. With ergonomic design.

AKD PRODUCT



ENDO EI.PT.MF
Multifunction Handpiece

Orthopedic Handpiece/Powertool with Multifunction Drill type that can be used in trauma operation (plate and screw implant installation), kirschner wire installation (K-Wire pinning), and acetabular reamer. Has replaceable attachment tips with 4 types, namely AO Drill, Bone Drill, K-Wire Driver, and Acetabular Reamer

AKD PRODUCT



ENDO EI.PT.SS
360° Sagittal Saw System

Orthopedic Handpiece/Powertool with Sagittal Saw type that can be used in bone cutting procedures (Amputation or Arthroplasty). The head saw unit can be rotated 360 degrees, making it easier for the operator/user to operate the tool on hard-to-reach body parts.

AKD PRODUCT



ENDO EI.PT.RD
Acetabular Reamer Drill

ENDO EI.PT.RD is an instrument for application in acetabulum reaming in joint surgery. With perfect ergonomic design, the whole unit can be autoclaved, imported motor, low noise, high torque, long service life. Different interfaces can be customized according to different factory spindle and reamer.

AKD PRODUCT



ENDO EI.PT.BD
Bone Drill

ENDO Bone Drill EI.PT.BD is an instrument used for hole drilling applications on plates and screws during trauma surgery. This instrument has a small volume, is lightweight, does not require a power cable, is easy to carry and operate, thus reducing operating time.



Karinca M206-300

Sagittal Saw System

Sagittal saw system (*Without saw blades and power box). High-Low speed options. Steam sterilisable 11.000 - 14.000 cpm / 4 standart 50'. 77 x 158 x 218 mm / 930 g

Karinca M206-235

Reciprocating Saw System

Reciprocating saw system (*Without saw blades and power box). High-Low speed options. Steam sterilisable 11.000 - 14.000 cpm / 4 mm 77 x 182 x 212 mm / 960 g



Karinca M206-200

Hexa Function Drill System

Dual Trigger system for speed control and direction control. Steam sterilisable. Drill mode F&R (1200 rpm). Drill Oscillation Mode (1200 cpm) 77 x 137 x 212 mm / 920 g.

Karinca M206-240

Sternum Saw System

Sternum saw system (*Without saw blades, guide and power box). High-Low speed options. Steam sterilisable. 11.000 - 14.000 cpm / 4 mm 77 x 180 x 212 mm / 1040 g.



Skin Graft Mesher

Surgical Instrument

Skin Graft Mesher is a surgical instrument used for skin transplantation. Single cutter cuts skin graft into geometrical shaped mesh & enlarge skin surface. Graft expansion predetermined by graft carrying plates, eliminating need to change cutter during operation.

Dermatome

Skin Transplantation

Dermatome is a device used for skin transplantation. It can be used with three possible technologies: battery, electro-motor and pneumatic User friendly, battery powered high torque motor design. No need to connect electric supply or compressed air.

Dermatome ST-5

Skin Transplantation

Special designed hand pieces for different operation variations. Small, medium and large head designs provides precise cutting results in different areas. Light weight and cordless, battery operated ergonomic system offers mobility.

Titanium, Mini Fragment
Trauma Implant

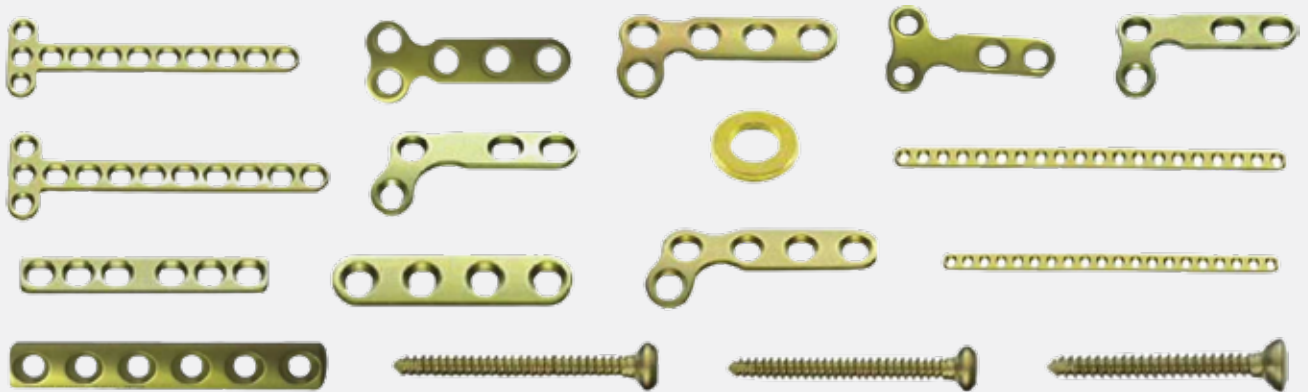

Titanium, Small Fragment
Trauma Implant

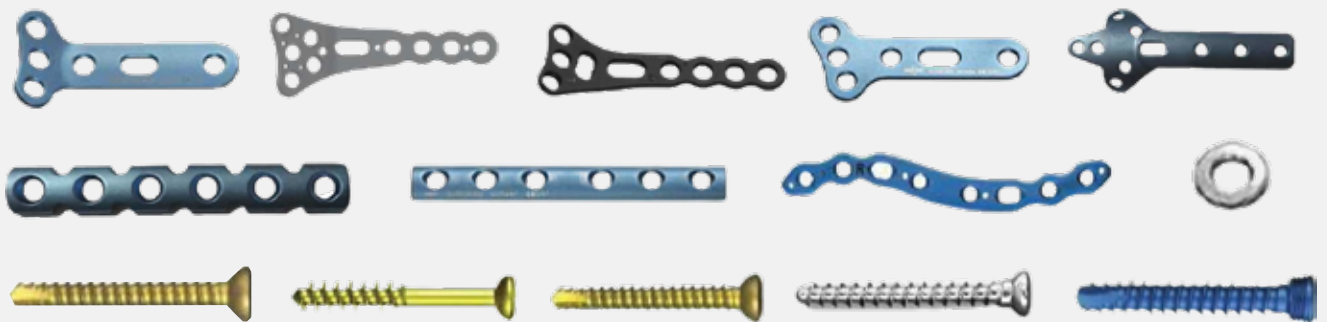

Titanium, Large Fragment
Trauma Implant



Titanium, Shoulder Fragment
Trauma Implant



Interlocking Nail



KTO Femoral Intramedullary Nail



KTO Tibial Intramedullary Nail



KTO Humerus Intramedullary Nail



KTO PFNA Gamma Nail

Stainless Steel, Locking Fragment

Trauma Implant



Stainless Steel, Non Locking Fragment

Trauma Implant





Bencox Cup System

Hip System

Acetabular component is hemisphere -shaped, maximizing the peripheral and polar contact at once. Three screw holes are anatomically designed and located for more effective fixation; and enough insertion angles are allowed to simplify the surgery.



Bencox Bipolar Cup

Hip System

A large array of component allows precise patient matching for optimal patient fit. Outer diameters from 38 to 60mm allow the surgeon to meet the unique challenges posed in a revision and extended situations. The bipolar cup offers use with 22, 28mm femoral heads.



Bencox ID Cementless Stem

Hip System

Cementless and cemented stem of ID system use same instrumentation. This instrumentation maximizes efficiency in the operating room, while still providing intraoperative flexibility. Provides the primary and secondary stability. Protects osteolysis from the wear debris.



Bencox ID Cemented Stem

Hip System

Cementless and cemented stem of ID system use same instrumentation. This instrumentation maximizes efficiency in the operating room, while still providing intraoperative flexibility. Proximally tapered & grooved stem geometry converts the shear forces to the compressive load.



Corentec Lospa Knee System & Modular Knee System

Knee System

Lospa knee system : Single axis concept for articular stability with flexion and improving range of motion. Anterior flange shape and dimension for the optimal patella tracking.

Modular knee system : Stability Constrained motion Increased AP stability, Modularity Stem extension available Augmentation. Longevity Stabilized concave tibial post Secured insert locking rod.



Corentec Coralis Reverse Shoulder System

Shoulder System

The Coralis Shoulder System allows for easy conversion from an anatomic or hemi to reverse prosthesis. The Coralis planers can be used to modify the bone as needed to maintain 135 degree inclination for easy conversion from Total to Reverse Shoulder.



Spacer for Hip
Preformed Spacer

The wide range of preformed spacer includes 18 variants. Four typology of stem combinable with 3 sizes of head and 2 options of antibiotic (gentamicin or vancomycin + gentamicin).



Spacer for Knee
Preformed Spacer

The wide range of preformed spacer include 18 variants. Four typology of stem combinable with 3 sizes of head and 2 options of antibiotic (gentamicin or vancomycin + gentamicin)



Spacer for Shoulder
Preformed Spacer

The Tecres spacer for Shoulder has a load-bearing structure in stainless steel coated with gentamicin bone cement and it resembles a shoulder prosthesis



Cemex Genta System
Bone Cement

Greater safety: with less monomer than any other cement on the market, Cemex is the acrylic resin with the lowest toxicity for anyone coming into contact with. Less heat given off: every gram of monomer generates heat amounting to 130 Kcal.



Cemex Genta ID Green
Bone Cement

Reduced shrinkage: shrinkage is the reduction in volume of the cement following its polymerization. It is directly proportional to the amount of liquid present. As the amount of monomer required is reduced, shrinkage is also reduced, thus greatly improving implant fixation



Mendec Spine
Bone Cement

Mendec spine is the user friendly low viscosity spine resin. The preparation process is easy and safe, and does not require an external mixer. Its optimal fluidity and its viscosity-allow an easy injection for an extended time and enough quantity for multilevel treatment.

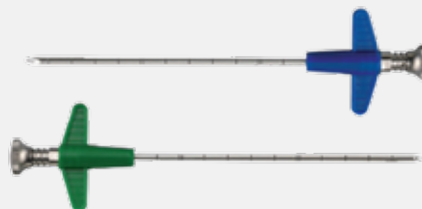

Beveled Tip & Diamond Tip
Bone Injection Needles

Luer-Lock connection system. Shock resistant metal head. Ergonomic handle in radiotransparent plastic or steel. Needle direction marker 9 gauge x 150 mm - Code ASB0000. 11 gauge x 120 mm - Code ASB0010. 13 gauge x 120 mm - Code ASB0020. 15 gauge x 120 mm - Code ASB0120

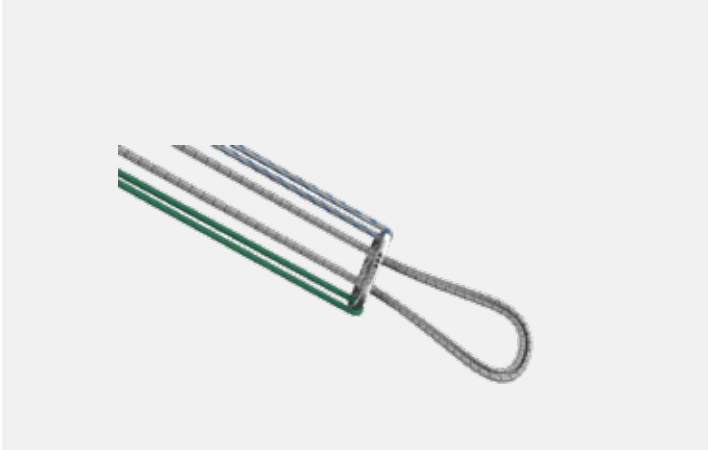

PULLUP Endobutton

ACL PCL Reconstruction

Reproducible, controlled locking at blind tunnel endstop, conservation of bone stock. Simple, no pre-op planning of tunnel length, perioperative adjustment. Reliable, stable locking system, renowned materials.



LIGAFIX Interference Screws

ACL PCL Reconstruction

Bioabsorbable, made of duosorb material, the implant are absorbed progressively and do not compromise future interventions. Osteoconduction, the high level of TCP promotes bone ingrowth.



MENIX Meniscal suture system

Meniscal repair system

On average, 53% of meniscectomies result in osteoarthritis in patients. The Menix and Menix Duo meniscal repair system offers a robust, reproducible and rapid meniscal repair technique.



POWERTEX

Suture loaded with needle

The POWERTEX suture loaded with needle can be used during ACL reconstruction to suture a single semitendinosus tendon harvest as well as a classic soft tissue transplant.



FIXIT

Pre-loaded Absorbable

Easy insertion, optimal tension maintained on the suture. Available from size 4.5mm. Absorbable threaded anchor. Composed of a bioabsorbable anchor & 2 UHMWPE sutures, the system is pre-loaded on a disposable screwdriver which allows a quick and reproducible implantation.



FIXIT KNOTLESS

Knotless Absorbable

FIXIT KNOTLESS is a bioabsorbable anchor which allows a quick and easy reproducible implantation while maintaining tension on the sutures. Slots for tightly wedging the strands to maintain optimal tension when screwing in the anchor



PEEK Cage PLIF, ACIF, TLIF

Lospa cage system is a spinal interbody fusion system that was developed to solve the drawback of current spinal fusion systems in the market. The cage, which closely resembles human anatomy, is designed for implantation between the endplates of the cervical vertebral bodies. motor



Monoaxial & Polyaxial Pedicle screw Pedicle screw

The components of Pedicle screw and Set screw are available in titanium alloy (ASTM F136) specifications as non-sterile and Gamma Sterilization. The rod components are available in titanium alloy (ASTM F136) or cobalt-chrome alloy (ASTM F1537) specifications as non-sterile and are either straight or pre-bent in configuration



MIS System Pedicle Screw Pedicle screw

LOSPA IS MIS system is a temporary, multiple component system comprised of a variety of non-sterile, single use components, made of titanium alloy, that allow the surgeon to build a spinal implant construct minimizing muscle injury. The system is attached to the



Rod, Set Screw & Rod Link Spine

Rod diameter 6.0 mm, lengt 40-500mm, set screw : as a specially designed screw thread tightens the set screw. Rod link it is simple assembling and strong stable fixation.

ENDO



Fenestrated

Non Fenestrated

ENDO Cannulated Pedicle Screw Pedicle Screw

ENDO Lumbar Fixation System is a comprehensive system with the design to optimize lumbar stabilization. The system comes with a variety of connectors. The complete set of the systems made of Ti-6Al-4V ensures users better, more secure, and safer implantation in spine surgery

ENDO



ENDO Cervical Pedicle Screw Pedicle Screw

The poly-axial screw is specially designed with 80° cranial caudal angulation which streamlines the lateral mass surgeries due to the wide angulation of the implanting site. Self-tapping and self-drilling characteristics ease out the process of surgical technique and shorten the surgical time.



Spinuss Pro Probe

Spine

Comprehensive Probe Series for Spine Endoscopy. World first higher power level 1~9. All fit in Spinal, Arthroscopy, ENT. Free voltage for global version. Compact design for user convenience



Spinuss Flex Probe

Spine

Endoscopy Flex Probe, Excellent hand grip, Sophisticated control. A stable plasma is realized by clearly separating the electrodes by making the tip of the tip in a unified structure



Spinuss Diamond & Round Burr

Spine

Spinuss burrs can be connected to the Shaver system you have. Connectors are provided with environmental considerations, and burrs can be used immediately after connection.



**Endovision UBE Scope Kit
(Telescope for Biportal Endoscopy Spine)**

Spine

Clear vision. Optimal saline flow. Smooth penetration. Economical instrument for hospital. Ready 0° and 30° endoscope. Light weight (Plastic Material) User fatigue is low when used for a long time



Endovision Freetome Punch-R

Spine

Shaft + Handle. Wide coverage of varied anatomy with diverse specifications. Used to grip, cut, or break bones during endoscopic surgery. User controllability maximization. 8 different angles and lock function

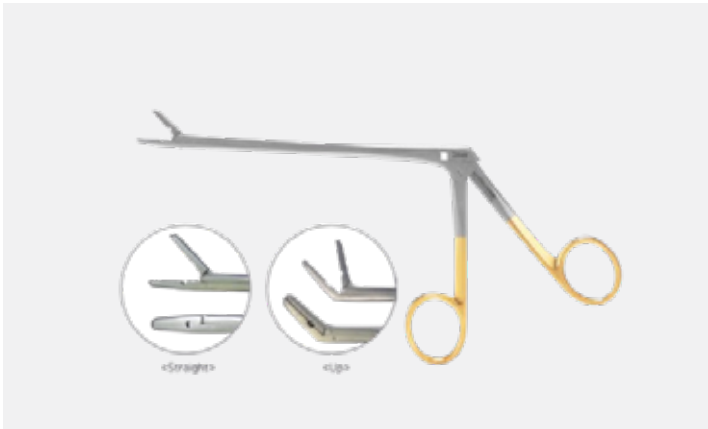

Endovision Tome Forcep

Spine

Is designed for tissue extraction and cartilage cutting. Improved safety. Easy and precise to us. Model : Straigh, Up

endovision
infinite vision of the medical device



Epidural Catheter System Cervical & Lumbar Spine

Used for percutaneous epidural neuroplasty. Non-invasive insertion. Minimizes tissue damage. Excellent rotation transmissibility. Thin and flexible tube. Precision steering

endovision
infinite vision of the medical device



Endovision Universal Retractor Spine

Retractor which is optimized for spinal endoscopic surgery which allows surgery without the help of an assistant. 2 Sets for Lumbar & Cervical. Instruments guider specialized. Free size up to 5mm to 15 mm

endovision
infinite vision of the medical device



Spinuss Tool Kit Spine

A total 24 instruments
A medical instrument set optimized for UBE Endoscopy
CE, MFDS patented

endovision
infinite vision of the medical device



Spinuss Fusion Instrument Set Spine

A total 9 instruments
A medical instrument set optimized for FUSION Endoscopy
CE, MFDS patented

GUARDIAN



Balloon Kyphoplasty Kyphoplasty System

Minimally Invasive Spine Surgery. Fast Pain Relief. Safe delivery of bone cement. User friendly approach. Local Anesthesia. Fast recovery

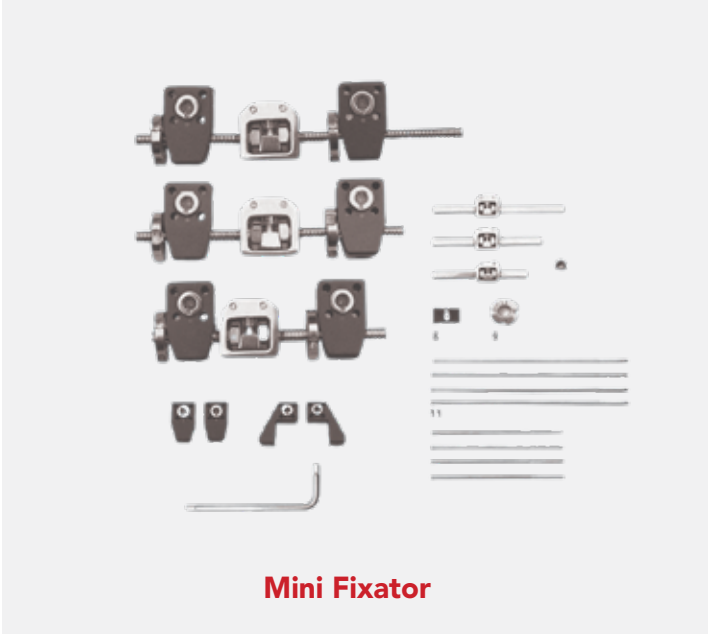

Mini Fixator

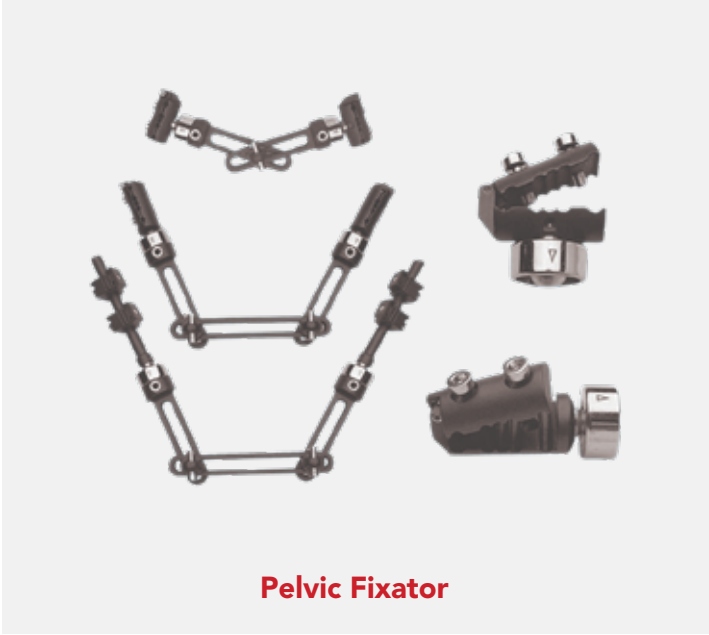

Pelvic Fixator



Paediatric Fixator



Paediatric Limb Reconstruction System



Elbow Fixator

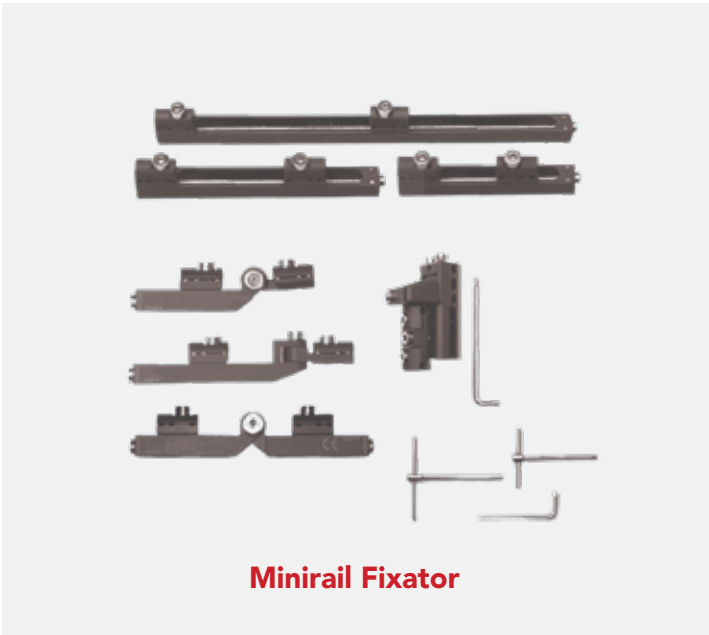

Minirail Fixator

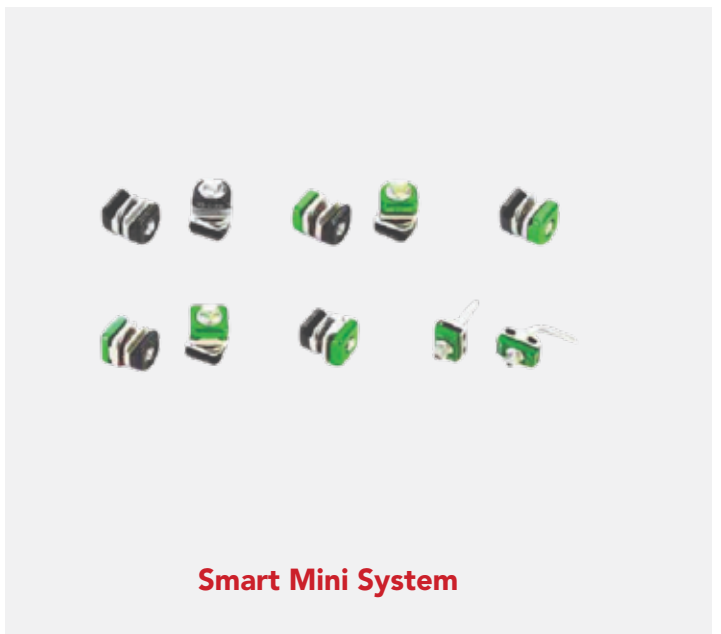
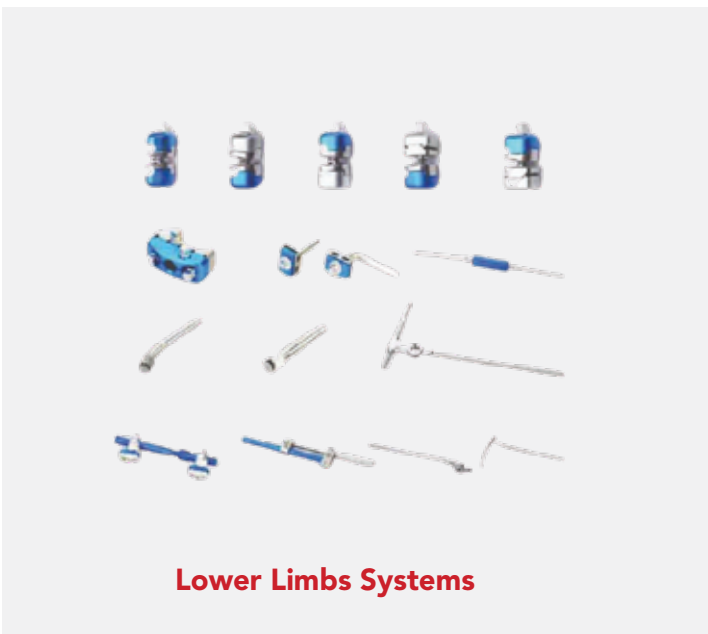
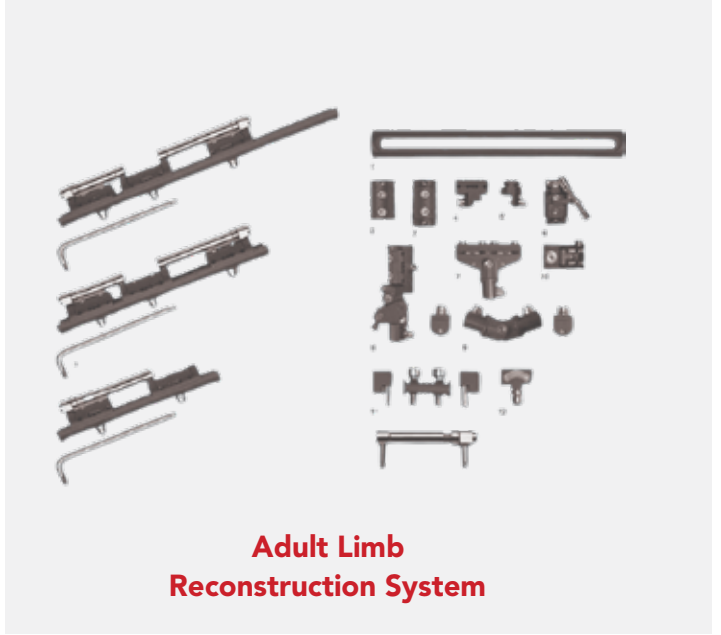
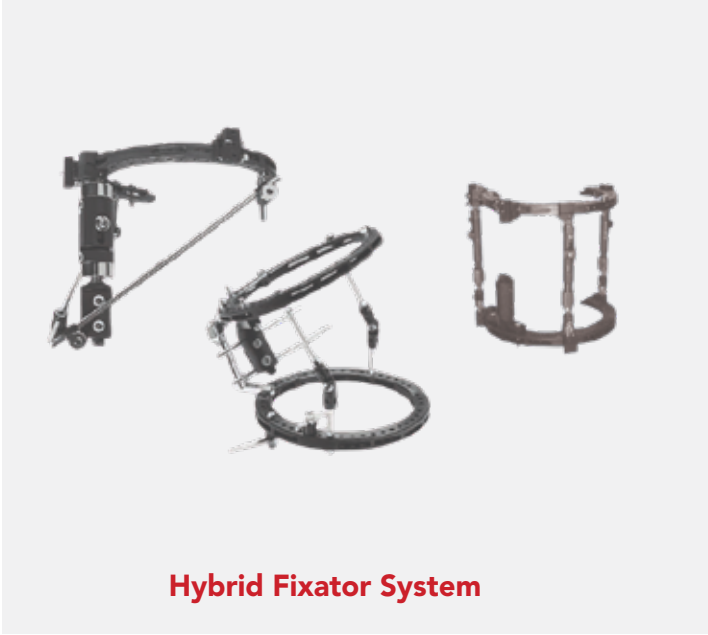

Duk-In



Cast

Plaster of Bandage

Expertise. The product of the only casting material specialized company in Korea. Consistent quality It always maintains consistent quality, smooth feeling and high solidity in modeling.



S-Splint

Synthetic Splint

Convenient use (pre-cut type). As various sizes are available, it can be immediately used only after selecting size. Anti bacterial and deodorization treated.



Lite-S

Fiberglass Casting Tape

Economical use. Use it the same way with plaster bandage. Its high strength saves the amount of use. Excellent molding. Patient can move after 30 minutes of application. Perfect penetration.

Maxillofacial Implant Set

ENDO

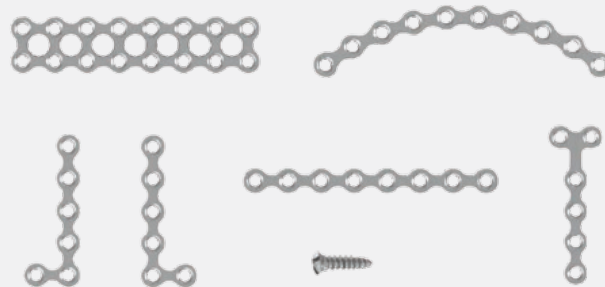

Special Trauma Implant

ENDO

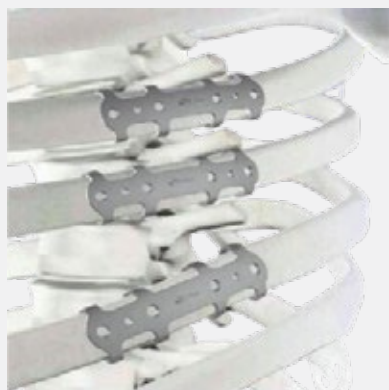

Ribs Plate



Patella Hook



Spinal Mesh



Suction Catheter With Thumb Control GS-2030TS
Bronchial Suction Catheter

Suitable for removal of secretions from mouth, trachea and bronchial tubes. Manufactured from non-toxic, non irritant medical grade PVC. Distal end is open with one lateral eye.



Guedel Airways GS-2012
Oropharyngeal Airway (OPA)

Guedel Airways are designed to maintain an unobstructed oropharyngeal airway during or following general anaesthesia and in patients who are unconscious for other reasons.



Oxy Lock GS-2038
Venturi Mask

Variable venturi mask system to ensure accurate concentrations of oxygen with single unit. Transparent air entertainment mask with soft anatomical form with easily adjustable elastic strap.



Oxy Set GS-2016
Nasal Cannula

Oxy Set is suitable for easy application and efficient administration of oxygen for greater comfort of the patient. Twin prong / nasal tips are designed to ensure equal volume of oxygen to both the air passages.



Aeromist GS-2074
Micro Mist Nebulizer Set

Soft, clear aerosol mask with anatomical form is ideal for long term use. Gently rolled, feathered edges with integrated nose bridge for extra comfort. Nebulizer rate 3cc / 10 mins.



Hi Mask GS-2044
Oxygen Mask with Reservoir Bag

High concentration oxygen therapy. Equipped with soft, transparent and odour free mask for greater patient comfort. Light weight reservoir improves the oxygen efficiency and patient comfort.



Flexi Mask GS-2020
Oxygen Mask

Flexi Mask is designed for convenient oxygen therapy. Moulded face mask is manufactured from non-toxic, non irritant medical grade PVC. Swivel connector for convenience of attachment to the oxygen tube.



Epidural Kit GS-2026
Epidural Anesthesia Kit

EPIDURAL/TUOHY NEEDLE : Tuohy type needle is provided with clear depth marking for accurate insertion depth reading, polished inner bevel edge minimize the risk of catheter shearing.



Resq Bag GS-2050, GS-2052
Silko Mask GS-2049

Manual Resuscitators and Spare Mask for Manual Resuscitators
Resq Bag kit consists of a Manual Resuscitator, Multichannel. Kink Resistant Oxygen Tubing, Reservoir Bag & Mask. Silicone. Resuscitator provides excellent bag re-expansion property.



Catheter Mount GS-2040
"T" Connector

Double swivel elbow connector with suction port & cap provides better flexibility, easy accessibility & provide comfort to patient during suction. Collapsible corrugated tubing is inert to all anaesthetic gases & reagents.



Endotracheal Tube (Plain) GS-2002
Endotracheal Tubes

Manufactured from thermosensitive material readily conforming to body contours at body temperature. Naso-oral tip Suitable for Nasal and Oral intubation. Kink resistant tube minimizes possibility of tube occlusion.



Endotracheal Tube (Cuffed) GS-2004
Endotracheal Tubes

Thermo sensitive tube softens at body temperature to conform to the anatomy of the respiratory tract. Kink resistant inflation tube ensures patient safety during cuff inflation and deflation.



Romovac Set GS-5002F, GS-5002N

Close Wound Suction Unit

Redon drain catheters are provided with radio opaque line and satin smooth eyes. Connecting tube is kink resistant & is provided with additional strength to withstand the suction.



Romoseal GS-5020, GS-5031

Water Seal Drainage System

Easy to read graduation help to determine the drain volume precisely. Clearly marked initial level ensures the under water seal. Kink resistant large bore tubing facilitates unrestricted flow.

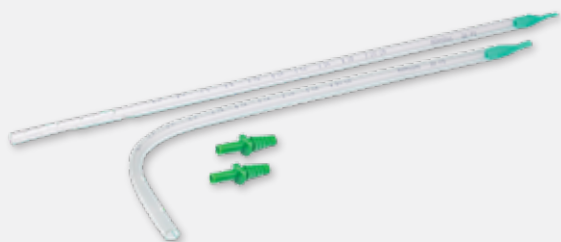

Chest Drainage Catheter GS-5010

Drainage Catheter

Thoracic Drainage Catheters are most suitable for post operative drainage after cardio-thoracic and thoracic surgery. Catheters are marked at every 2 cm from the last Eye to ascertain the depth of placement.



Thoracic Trocar Catheter

Catheter with Trocar

Specially designed for quick non operative pleural and chest drainage for the relief of chest conditions such as tensions pneumothorax. Catheter manufactured from medical grade PVC is snugly fitted over the trocar.



Yankaur Suction Set GS-5016 A

Yankaur Suction

Complete set is provided with Yankaur Suction Tip mounted on two meter long ribbed tube provided with. Universal connector at both ends. Ribbed tube is kink resistant and has the strength to withstand the suction.



Vaccu Suck, Suction GS-5016

Yankaur Suction

Moulded Yankaur Suction handle attached with 2.5mtr tube. Vent port is permanently closed with tight fit sleeve, which can be removed with small incision by blade to change over to vent control system.



Suction Connecting Tube GS-5017

Suction Tube

Suction connecting tube with Molded Connectors. Flexible connectors ensure easy and secure connection. Easy connection to suction canisters on one end, and Yankaur suction handle/ tip at the other end.



Tracheostomy Tube Plain, GS-2008

Tracheal Tubes Plain

Tracheostomy Tube - A tracheostomy tube, or "trach tube", is a 2-inch to 3-inch-long curved metal or plastic tube placed in a surgically-created opening (tracheostomy) in the wind pipe to keep it open.



Tracheostomy Tube (Cuffed), GS-2010

Tracheal Tubes Cuffed

Soft low pressure cuff dynamically adjusts the pressure at the point of contact during the breathing cycle. Thus minimizes the risk of tracheal trauma and other complications. Supplied with cotton neck tape.



Urine Bag GS-1020

Urine Collecting Bag

Closed urine drainage system for short and long term use. Manufactured from soft clinical grade PVC sheeting. Reinforced eyelets allow easy hanging and provide maximum protection against tearing.



Urine Leg Bag GS-1024

Urine Leg Bag

Suitable for day and night use for incontinence. Manufactured from soft clinical grade PVC sheeting. Available with "T" type bottom outlet. avNon-return valve to prevent the back flow of urine.



Male Catheter GS-1010

Kondom Catheter

Male Cath is specially designed for urine incontinence for day and night use in male patients. Manufactured from 100% latex for soft and gentle feel. Provided with soft adhesive coated strip for proper fixation.



Urometer 250 GS-1018-250

Urine Bag (Measured Vol Chamber)

Specially designed for measurement of hourly urine output. Clear and transparent measured volume chamber provides accurate measurement. Urine chamber directly attached to the urine bag with overflow facility.



Urometer 500 GS-1018-500

Urine Bag (Measured Vol Chamber)

500ml transparent chamber has four line measuring sections to measure the accurate & precise volume of the urine. Collection chamber is provided with hydrophobic filter to minimize the risk of urinary tract infection.



Foley Catheter 3 Way GS-1094

Urine Drainage Catheter

Foley Catheter is a tube to remove urine through the urinary tract. This tool is a small, thin tube made of rubber or flexible plastic. The purpose of installing a urinary catheter is to empty the bladder in patients who are unable to urinate normally on their own.

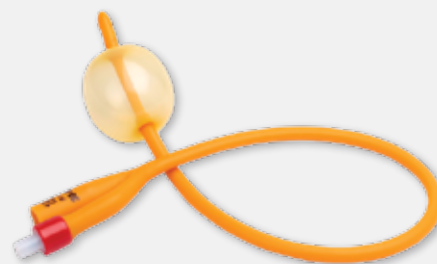

Foley Balloon Catheter 2 Way GS-1072

Urine Drainage Catheter

Manufactured from natural rubber coated with silicone to eliminate the risk of encrustation. Hard valve ensures easy inflation and deflation of balloon.



Nelaton Catheter GS-1004

Urine Drainage Catheter

Nelaton catheters are used for short term bladder catheterisation. Manufactured from non-toxic, non-irritant medical grade PVC compatible with catheter lubricants.



I.V Cannula GS-3022, GS-3031

Intra Venous Cannula

Kink resistant FEP-Teflon cannula has extremely smooth inner and outer surface to ensure minimum trauma and smooth flow. Transparent flashback chamber allows immediate detection of blood.



RMS Vented Infusion Set SS-3060

Infusion Set

Sharp piercing spike for easy insertion in I.V Container. Infusion set with built in air vent and bacteria barrier hydrophobic filter. Specially designed cylindrical collapsible drip chamber to visualize the flow rate.



**Microperf
Infusion Set Pediatric**

Micro drip infusion set with drop size reduced to 60 drops per ml for paediatric and critical therapy. Manufactured from non-toxic, clear and transparent P.V.C. material. Sharp piercing spike for easy insertion in fluid container along with built-in preventive bacterial air vent.



Blood Administration Set

Blood Transfusion Set

Conforms to ISO 1135-4. Cylindrical drip chamber provided with 200 micron filter to prevent passage of any clot into the chamber. Flash ball type injection port for extra medication.

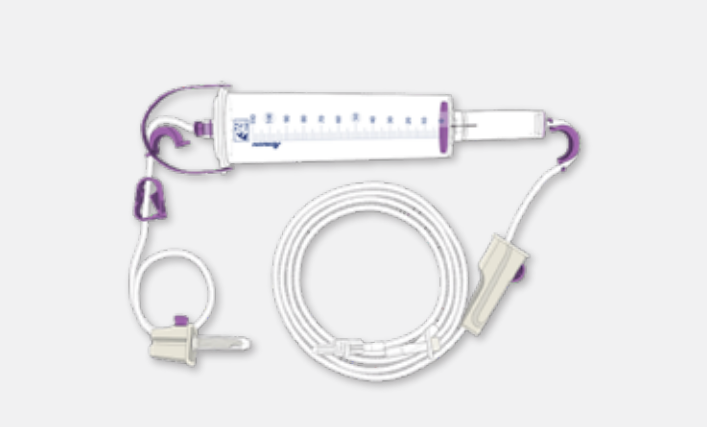

**Pediadrip Plus SS-3057
Infusion Set with Burette**

Burette type measured volume chamber of 100ml with 10ml overflow limit. Micro drip with drop sizes 60 drops per ml. Specially designed hanger facilitates the hanging of complete device on the I.V. stand.



Centro GS-3042

Central Venous Catheter Kit

Centro manufactured from specially formulated and biocompatible PU material. Specially designed soft tip catheter to make the insertion easy and non traumatic. Based upon much preferred Seldinger technique.



**Bi-Valve GS-3040
Three Way Stop Cock**

Three way stop cock are suitable for use during pressure infusion & invasive blood pressure monitoring. Manufactured from medical grade, clear transparent polycarbonate. Three arm handle is easy to operate.



Vein O Line GS-3034

Three Way with Tube

Male luer lock at one end and 3-way stop cock at other end and fits all standard equipment. Sterile, individually packed in peelable soft blister pack. Length: 10, 100cm.



PM-O-Line GS-3036

Perfusor Line

Small bore high pressure extension line. Suitable for high pressure monitoring. Provided with male and female luer lock at either ends and fits all standard equipment.



Romolene GS-4032

Nasogastric Tube (NGT)

Suitable for nasogastric introduction, for nutritional purposes or aspiration of intestinal secretions. Manufactured from medical grade PVC. Radio opaque line is provided throughout the length



Infant Feeding Tube GS-4008

Infant Feeding Tube

Manufactured from DEHP free PVC. Suitable in neonatal and paediatric enteral nutritional feeding. Distal end is coned with two lateral eyes.



Feeding Bag GS-4028

Feeding Bag, Gravity Bag

Specially designed 1.2 Lit. capacity bag for feeding purpose. An ice pouch is provided with the bag for preserving the food for longer period. A transfer set is directly connected to the bag for easy feeding.



Mucus Extractor GS-5018

Infant Mucus Extracting Device

Used for aspiration of secretion from oropharynx in newly born babies to ensure free respiration. Clear transparent container permits immediate visual examination of the aspirate.



Respirometer GS-6018

Breathing Exerciser

Innovative system to exercise respiration through inspiration. Specially designed with three stage chambers to provide more efficient exercise to patient on a step up basis.



Umbilical Cord Clamp GS-508

Clamping Devices, Umbilical Clamp

Suitable for clamping the umbilical cord of new born baby, immediately after birth. Provided with dual security lock with distinct "click" to indicate the correct locking.

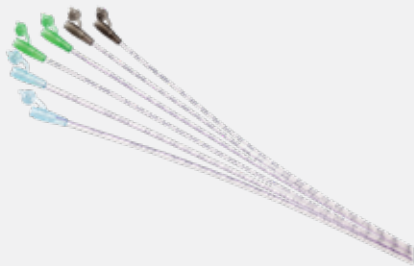

Umbilical Catheter

Umbilical Catheter

Special designed carger for intermittent access to the umbilical vessles of new born. Smooth round tip helps easy cannulation. Open distal endo without lateral eyes, eliminates the chance of clot formation in the blind spaces.



Dignity Mathey Underpads GS-8414

Underpads

Clinically Proven. Top sheet gives soft cloth like comfort. PE back sheet prevents leakage. Tissue with better core integrity. Unique quilted pattern. Side seal prevents leakage.



Dignity Overnight Pull-Ups

Adult Diapers

Clinically proven. Used for bladder control for both men and women. Higher absorbency. Advance leakage protection. Provides full profile coverage. Maintain dry feeling and no skin irritation.

KANG JIAN®

ENDO - KANG JIAN Vacuum Tubes



Nama Item	Spesifikasi	Volume	Additive	Qty / Box	Qty / Karton
K2.EDTA 3 mL - Glass	Ø 13x75 mm	3 ml	EDTA K2	100	1800
K2.EDTA 2 mL - Glass	Ø 13x75 mm	2 ml	EDTA K2	100	1800
K3EDTA 3 mL - Glass	Ø 13x75 mm	3 ml	EDTA K3	100	1800
K3EDTA 3 mL - Glass, for Soft Needle	Ø 13x75 mm	3 ml	EDTA K3	100	1800
K3EDTA 3 mL - Plastic	Ø 13x75 mm	3 ml	EDTA K3	100	1800
K3EDTA 2 mL - Glass	Ø 13x75 mm	2 ml	EDTA K3	100	1800
K3EDTA 0.5 mL - Glass		0.5 ml	EDTA K3	100	3000
Plain / Serum 3 mL - Glass	Ø 13x75 mm	3 ml	Plain / No Additive	100	1800
Plain / Serum 3 mL - Plastic	Ø 13x75 mm	3 ml	Plain / No Additive	100	1800
Plain / Serum 5 mL - Glass	Ø 13x75 mm	5 ml	Plain / No Additive	100	1800
Plain / Serum 5 mL - Plastic	Ø 13x75 mm	5 ml	Plain / No Additive	100	1800
Plain / Serum 10 mL - Glass	Ø 16x100mm	10 ml	Plain / No Additive	100	1200
Clot Activator 3 mL - Glass	Ø 13x75 mm	3 ml	Clot Activator	100	1800
Clot Activator 3 mL - Plastic	Ø 13x75 mm	3 ml	Clot Activator	100	1800
Clot Activator 5 mL - Glass	Ø 13x75 mm	5 ml	Clot Activator	100	1800
Clot Activator 5 mL - Glass, for Soft Needle	Ø 13x75 mm	5 ml	Clot Activator	100	1800
Clot Activator 5 mL - Plastic	Ø 13x75 mm	5 ml	Clot Activator	100	1800
Sodium Citrate 1.8 mL - Glass	Ø 13x75 mm	1.8 ml	Sodium Citrate	100	1800
Sodium Citrate 2.7 mL - Glass	Ø 13x75 mm	2.7 ml	Sodium Citrate	100	1800
Sodium Fluoride 3 mL - Glass	Ø 13x75 mm	3 ml	Sodium Fluoride	100	1800
Lithium Heparin 4 mL - Glass	Ø 13x75 mm	4 ml	Heparin Sodium	100	1800
Gel Clot Activator 3 mL - Glass	Ø 13x75 mm	3 ml	Gel & Clot Activator	100	1800
Gel Clot Activator 3 mL - Plastic	Ø 13x75 mm	3 ml	Gel & Clot Activator	100	1800
Gel Clot Activator 5 mL - Glass	Ø 13x75 mm	5 ml	Gel & Clot Activator	100	1800
ESR Tube 1.28 mL	Ø 9x120 mm	1.28 ml	Sodium Citrate	100	1800



Colostomy Bag Colostomy Bag

The skin friendly and very flexible skin wafer is made of 100% hydrocolloid. The very soft, breathable, and water resistant tissue is comfortable against the skin and prevents perspiration forming underneath the pouch.



Ileostomy Bag Ileostomy Bag

Used to collect feces and gas from patients who cannot defecate normally. One piece system. Drainable, there is a discharge system to empty the bag. 500ml bag volume



Urostomy Bag Urostomy Bag

Used to accommodate the urine of patients who cannot urinate normally. One piece system. Drainable, there is a discharge system to empty the bag in the form of a flexible tap. Cut to fit type, adjusts stoma diameter, from 10-60 mm.



ENDO Non-woven Adhesive Wound Dressing Strip without Pad
Wound Dressing

Provides light compression without causing constriction. Strong medical adhesive holds dressing safely, even in the presence of moisture. Easily cut to eliminate waste. Latex-free.



ENDO Non-woven Adhesive Wound Dressing with Pad
Wound Dressing

High MVTR, waterproof PU film/ spun lace non woven fabric allows excess moisture to pass away, reduces the risk of maceration. Bacterial barrier protects wounds against external contamination.



ENDO Hydrocolloid Dressing
Wound Dressing

Keep the wound in a moist environment, promote wound healing, effectively release pain and reduce care frequency. Water-proof, protect the wound from microbial invasion.



ENDO IV Dressing with Notch
Wound Dressing

Fuction.I.V. dressing is a moisture permeable dressing specially designed to meet the needs of catheter fixation and to keep the catheter site dry. Frame Style. Frame style transparent film I.V. dressing with notch. Paper frame design;



ENDO Film Island Dressing
Wound Dressing

High MVTR and waterproof PU film/spun lace non-woven fabric allows excess moisture to pass away, reduces the risk of maceration. Bacterial barrier protects wounds against external contamination



ENDO Nasopharyngeal Airway

Disposable Nasopharyngeal Airway

ENDO Nasopharyngeal Airway, Blue Trumpet type made of medical soft PVC, non-toxic, latex free. Smooth surface permits easy insertion and withdrawal.



ENDO Laryngeal Mask

Disposable Laryngeal Mask Airway

Made of medical silicone or PVC, and have good biocompatibility. Exclusive soft cuff can be insert comfortable and increasing sealing. Kink free tube eliminates the risk of airway tube occlusion.



ENDO Reusable CPAP Mask

CPAP Mask

Made from medical standard silicone material and suitable for all face shapes. The soft hood makes the user feel comfortable when worn. The design of the hood fits perfectly with the contour of the face so there is minimal leakage.



ENDO Disposable Breathing Circuit

Disposable Breathing Circuit

Proper design assures good conformability and lower tube resistance. Tube types: Corrugated. Size: Adult 22mm, Pediatric 15mm. Available with different length.



ENDO Reinforced ETT Cuffed

Reinforced Endotracheal Tube Cuffed

Made of medical grade PVC, for single use only. Reinforced Cuffed Murphy eye reducing the risk of occlusion and maintaining airflow High volume low pressure cuff providing good sealing.

ENDO ECG Electrode Disposable

Disposable ECG Electrode



ENDO ECG Electrode SF11
(Pediatric)



ENDO ECG Electrode SF40
(Adult / Child)



ENDO ECG Electrode SF08
(Adult)

Specification	ENDO Disposable ECG Electrode SF11
Description	Pediatric, Solid Gel, Round, Ø 30 mm
Packaging	50/pk, 40pk/cs
Case Dimension	40 x 36 x 28 cm

Specification	ENDO Disposable ECG Electrode SF40
Description	Child/Adult, Solid Gel, Oval, 43*46 mm
Packaging	50/pk, 40pk/cs
Case Dimension	40 x 36 x 28 cm

Specification	ENDO Disposable ECG Electrode SF08
Description	Adult, Solid Gel, Round Ø 50 mm
Packaging	50/pk, 40pk/cs
Case Dimension	48 x 36 x 28 cm

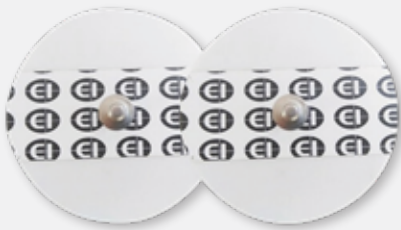

ENDO ECG Electrode

ECG Electrode

Used for various ECG Test. It uses an Ag/AgCl sensing element and Hydro-gel for adhesion . An Ag/AgCl sensing element has the best sensitivities and the solid adhesive hydro-gel has very low impedance.

ENDO Monopolar Pencil

Electrosurgical Pencil

Ergonomic and lightweight. Design is comfortable and minimizes fatigue. Water resistant construction minimizes electrical shocks and inadvertent activations.



ENDO Disposable Plate GP03

Electrosurgical Unit

Monopolar use. Designed for optimal conductivity and adhesive. Optimal hydrogel of low impedance characteristics removal of the Hot spot area. Applied biocompatible hydrogel and adhesive No side effects caused by backing and gel adhesive



ENDO Disposable Plate GP04

Electrosurgical Unit

Bipolar use. Designed for optimal conductivity and adhesive. Optimal hydrogel of low impedance characteristics removal of the Hot spot area. Applied biocompatible hydrogel and adhesive No side effects caused by backing and gel adhesive



USG Gel 5L and 250ml Ultrasound Gel

Based on the same "can't be copied" formula of the World Standard; Ultrasound Transmission Gel, without fragrance or color. For diagnostic and therapeutic medical ultrasound procedures, like obstetrics, gynecology, digestion urinary and nervous systems, etc.

No fragrance. No color (transparent). Based on the same "can't be copied" formula of the world standard. Acoustically correct for the broad range of frequencies used. No formaldehyde



ENDO Latex T-Drainage Tube Latex T-Drainage Tube

Specifications: Kher's Tube, Made of silicone-coated latex, Non-toxic, non-pyrogenic, Sterile, Length 16 x 38 cm, For wounds or biliary drainage, Disposable.



ENDO Rectal Tube

Made from soft non-toxic and non-irritant medical grade PVC material. Equipped with color code for size identification. Distal end with 2-sided holes. Available in length 40 cm.

AKD PRODUK

ENDO



ENDO Medical Recording Chart Paper



- ECG/EKG Paper • Treadmill Paper • CTG/NST Paper • Defibrillator Paper
- Chemistry Analyzer Paper • Spirometer Paper • Audiometer Paper
- Hematology Analyzer Paper • Chemistry Analyzer Paper
- Auto Refractometer Paper

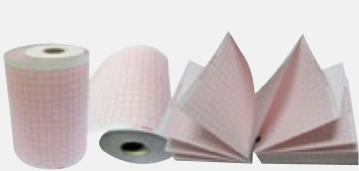

ECG Paper

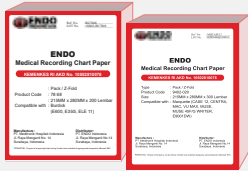

Treadmill Paper

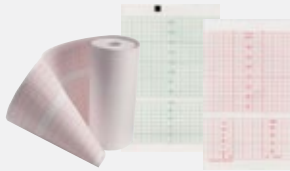

CTG / NST Paper



Thermal Paper

- Dark and vivid print out
- Medical Grade Material
- Accurate precision
- Consistent quality and supply reliability, for more than 100 Paper types for use on most major machine brands.



USG Video Printer Paper

- Compatible USG Paper for Sony UPP-110HG
- Long Lasting Image Durability for High Storage Stability
- Precise, High Resolution Image Reproduction
- Trouble-free Printing & Long-Term Use of Printer

AKD PRODUK

ENDO

ENDO Medical Face Mask



Comfortable Earloop

Innovative earloop made of fabric that is soft and wider in size provides comfort on the skin and reduce pressure to the ears for long-time use.



3 Layers of Protection

The 3-ply thicker layers will give a stronger filtering effect, but also breathable, soft, and gentle to the skin at the same time.



The Wider Coverage

It can fully cover mouth, nose, and chin.



Adjustable Nose Wire

Secure fit to shape easily the contoured over the nose for a better protection.

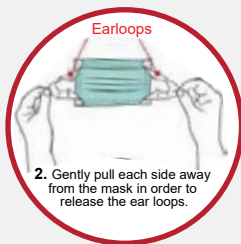
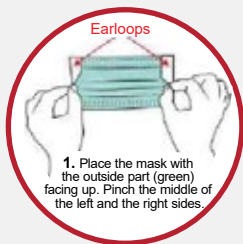



Oasis Elite Closed Head Ring

Head and Neck Protection

Unique gel and foam combination conforms comfortably to the patient's head, this head ring is suitable for use in many surgical procedures.

Adolescent with dimension 140x34mm (EL011)
 Adult with dimension 200x50 mm (EL012)



Oasis Elite Prone Head Rest

Head and Neck Protection

Developed in conjunction with the operating staff at a leading hospital, the Oasis Elite Prone Head Rest is anatomically designed so that the patient's head can comfortably rest face down with respiratory tubes in place.

Adult with dimension 280x240x140mm (EL141)



Oasis + Head and Neck Support

Head and Neck Protection

The oasis + head and neck support is ergonomically designed to support the head and neck. The product has anti slip properties designed for additional safety.

Adult with dimension 264x220x64mm (OP151)

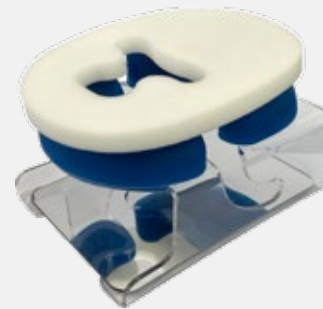

Clearview Prone Headrest

The Trulife Clearview Prone Headrest raises and supports the head while offering maximum pressure relief. A clear acrylic base and mirror to allow the patient's eyes to be monitored. Chin and forehead silicone positioners that can be adjusted to suit the patient's head.

Clearview Prone Headrest (CVP01)
 Clearview Foam Face Pads (CVF01)



Oasis Elite Supine Head Rest

Head and Neck Protection

This Supine Head Rest is ideal for positioning the patient during eye surgery and other supine procedures. Ergonomically shaped to position the patient's head, while effectively protecting against the onset of pressure sores.

Adult with dimension 275x237x90mm (EL151)



Oasis Elite Open Head Ring

Head and Neck Protection

Combination of gel and foam provides stability and protection to the patient's face during surgery. An opening allows for intubation.

Adult with dimension 200x54mm (EL022)

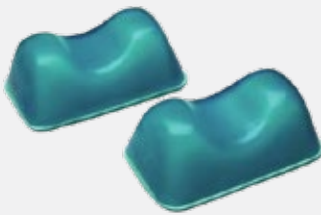

Oasis Elite Heel Pads

Ankle, Heel and Foot Protection

The Oasis Elite Heel Pads provide support and maximum protection for the heels, even during the longest surgical procedures. They support the Achilles and effectively remove pressure from the heels.

Adult with dimension 180x100x70mm (EL130)



Oasis Elite Armboard Pad

Arm and Elbow Protection

This flat armboard pad has a slight indentation to cradle the arm and provide effective pressure relief during various surgical procedures.

Adult with dimension 600x125x20mm (EL072)



Oasis Elite Knee Pad

Leg Protection

The Knee pad is used for various procedures in the prone position to protect the knees against pressure damage and the onset of pressure sores.

Adult with dimension 510x155x40mm (EL401)

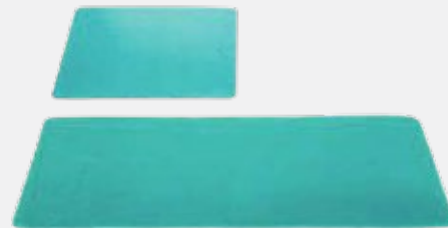

Oasis Elite Table Pads

Table Pad Protection

The oasis elite table pads can be used to protect the body in all surgical positions. The ultra light weight pad consist of a foam base and a gel top, allowing for easy carrying.

Universal table pad dimension 520x520x30mm (EL030)
3/4 length table pad dimension 1150x520x20mm (EL031)



Azure Sacral Protector

Body Protection

The Sacral area is an area of serious risk if left unprotected. The Azure Sacral protector has been designed to provide support in the supine and lithotomy positions by relieving pressure and focussing on peripheral support.

Adult with dimension 450x445x30mm (AZ301)

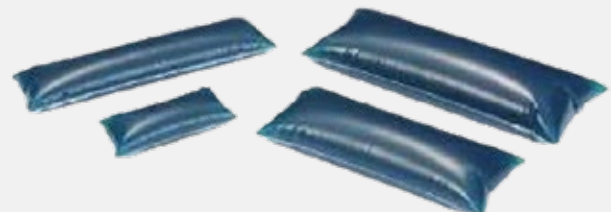

Oasis Universal Patient Positioners

Body Protection

These 100% silicone positioners are suitable for safe and effective positioning during all surgical procedures.

Adult with dimension 290x100x60mm (OA052)



Oasis Elite Large Prone Positioner
Body Protection

The Large Prone Positioner eliminates pressure on the abdomen and facilitates easy ventilation and circulation during long cases in prone position, i.e surgeries to the backs of legs and laminectomy procedure.
Dimension 1115x520x140mm (EL904)



Oasis Elite Lateral Park Bench Positioner
Body Protection

The Park Bench position is a modification of the Lateral position. This position provides the surgeon with better access to the Posterior Fossa in the Skull.

Adult with dimension 520x413x230mm (EL913)

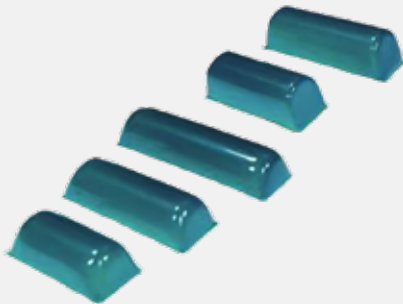

Oasis Elite Flat Bottom Chest Rolls
Body Protection

Chest Rolls provide excellent support and stability. The unique gel and foam combination means they are up to 75% lighter than comparative gel products, allowing for easy manipulation and handling by OR staff.

Adult with dimension 505x140x110mm (EL216)
Adult with dimension 510x150x150mm (EL218)



Oasis Elite Prone Positioner
Body Protection

The Prone Positioner gel and foam combination has been designed to provide effective positioning to the patient during surgical procedures in the prone position. For best protection, it is recommended to be used in conjunction with the Prone Head Rest.

Adult with dimension 610x530x130mm (EL903)



Elite Foam Universal Positioner
Elite Foam Positioner

Unique two layer foam, lightweight with a fully sealed cover. Suitable for X-Ray.

Dimension 330x230x50mm (ELP011)



Elite Foam Roll Positioner
Elite Foam Positioner

Unique two layer foam, lightweight with a fully sealed cover. Suitable for X-Ray.

Dimension 500x120mm (ELP214)



Active Flow
Breast Prosthesis

Trulife swim forms are ideal for all water activities. They retain their shape in and out of water. They can be used in chlorinated and salt water. The perfect combination of beads and moulded spacer fabric provide a flattering, natural profile, whether active or lying down.
Code : 630
Shape : Symmetrical Triangle
Sizes : 1-14



Silk Triangle
Breast Prosthesis

Silk defines what a breast form should be: soft and natural. All Silk breast forms offer a natural drape not found with other breast forms and are made from the highest quality of silicone for lasting comfort and softness. 30% lighter than traditional silicone breast forms.
Code : 471
Shape : Symmetrical Triangle
Sizes : 1-17
Fit : Shallow to Average



Teardrop Partial
Breast Prosthesis

Trulife offers soft partial silicone breast forms designed to provide the lightest and most natural symmetry for post-lumpectomy, post-reconstruction and enhancement of underdeveloped breasts. All partial breast forms feature tapered edges to ensure a flawless, smooth profile under clothing.
Code : 531
Shape : Symmetrical Teardrop
Sizes : 1-11

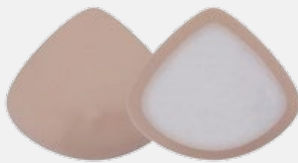

Silk Triangle Plus
Breast Prosthesis

Silk defines what a breast form should be: soft and natural. All Silk breast forms offer a natural drape not found with other breast forms and are made from the highest quality of silicone for lasting comfort and softness. 30% lighter than traditional silicone breast forms. Conformable back provides additional fullness and projection.
Code : 472
Shape : Symmetrical Triangle
Sizes : 1-17
Fit : Average to Full



Sublime Aris
Breast Prosthesis

These revolutionary breast forms are made using 100% pure silicone and feature a honeycomb core which ensures optimum breathability. The pure silicone design with tapered edges allows these breast forms to be worn directly against the skin for the most intimate fit.
Code : 151
Profile : Average
Sizes : 3-14



Barbara
Bra

Four core and a variety of fashion colors make this a favorite. This seamed style offers unparalleled support, and is highlighted with a lace trim that accentuates its loveliness.
Code : 210
Style : Lace Accent Softcup
Profile : Shallow to Average
Colors : White, Nude, Black



Jessica
Bra

This fashionable and preferred style features a built-in lacy camisole panel tailored to give you all-day security and comfort. Seamed soft cup design offers excellent support. Lace accents and lace camisole panel for an exceptionally feminine style.
Code : 4019
Style : Softcup
Profile : Shallow to Average
Colors : White, Nude, Black

ENDO

PT ENDO Indonesia

 Jl. Raya Menganti 14 Kedurus, Surabaya 60223

 +62-31-7673636

 +62-31-7673737

 info@endo.id

 <https://endo.id>