

**TONTARRA**

ENDOSCOPY

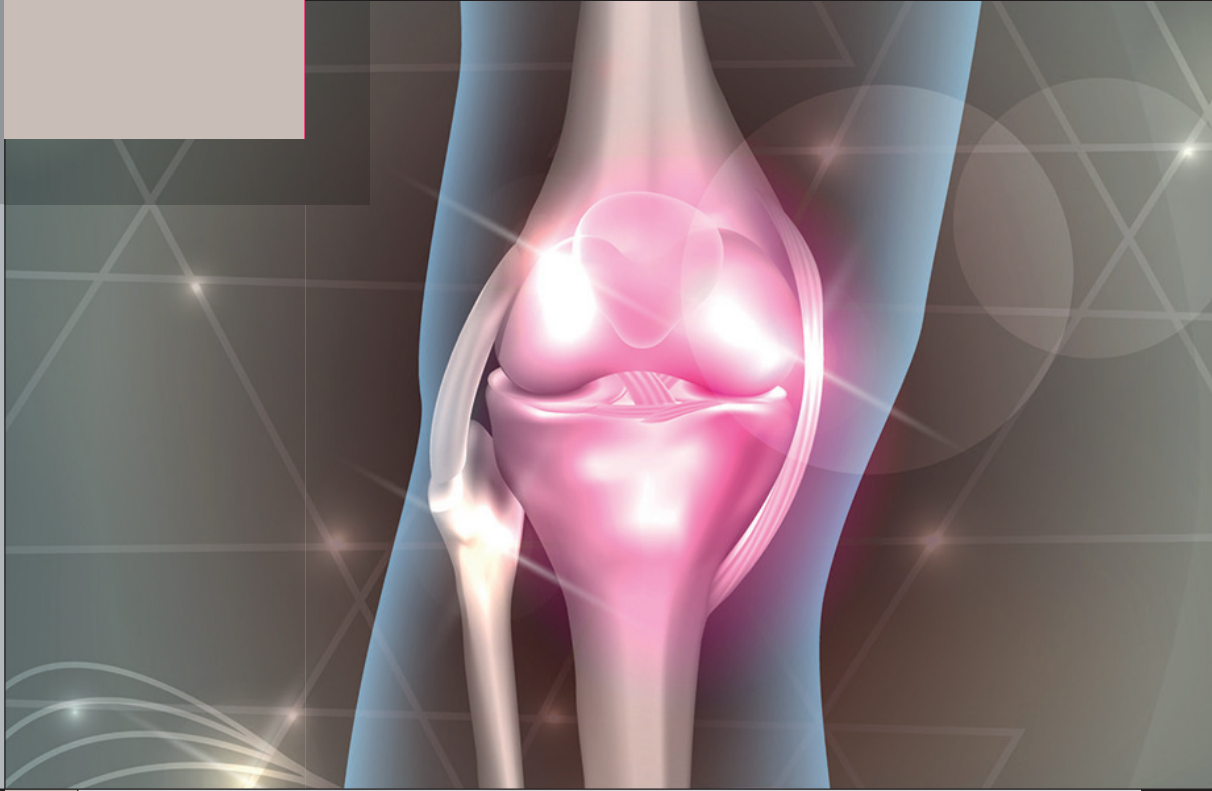

ARTHROSCOPY

# ABOUT US

For more than 50 years “made by TONTARRA, Germany” is a synonym for state-of-the-art surgical and endoscopic instruments and equipment.

This success and the international recognition of the skillfulness in surgical and endoscopic instrument making of Tontarra Medizintechnik GmbH are based on our commitment to medical innovation, mastery in manufacturing, and a strong focus on our continuing tradition of excellence.

The confidence in our surgical and endoscopic lines as expressed by our international customers, distribution- and OEM-partners are a driving force to face and meet new challenges.

# TONTARRA



Indispensable ‘tools’ for maturing new ideas into high-precision surgical instruments of highest precision include our state-of-the-art manufacturing facility and production processes, and especially the comprehensive technical know-how, ingenuity and strong commitment of our entire team.

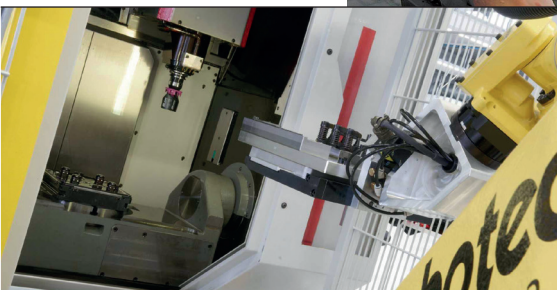
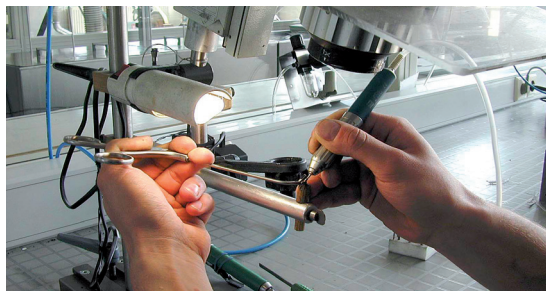

# ICONS – OVERVIEW



Function length



LuerLock



Quick Lock



For use with sheath in size



Round sheath



Oval sheath



Drop style sheath



Continuous flow



#### **Teloscopes and Instruments:**

TONTARRA telescopes and instruments are designed in particular for the demand and needs of diagnostic and therapeutic procedures for all endoscopic surgeries.

Premium multi-coated optical systems ensuring high-quality imaging by allowing excellent optical transmission as well as high brilliance in image reproduction. All optical systems of the TONTARRA endoscope line are sealed by using specially designed process for laser-welding and soldering. High quality scratch-resistant sapphire glass for proximal and distal sides of each optical system ensures extended longevity and durability.

A special focus on the very precise centering of all mechanical and optical components allows in-surgery imaging of high contrast and brightness even at the edge.

#### **STELLA-Arthroscopy-Line**

The TONTARRA premium arthroscopy instrument line with sliding sheath meet the particular needs of arthroscopic surgeons. The multiple designed tips are optimized to reach the specific areas of the joints. The small joint instruments with shorter sheath and lower profile tips are made for the special demands.

- manufactured according to TONTARRA-defined precision mechanics standards
- mechanically safe (no pins) and proved jaw design overload protected
- exclusively made in Germany
- a complete range of instruments is available
- backlash-free mechanics for one to one tactile feedback



**I**



**Sheath systems  
for Ø 4,0 mm  
telescopes  
(FL 175 mm)**

**8 - 11**

**II**

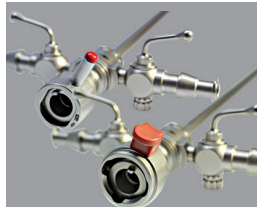

**Sheath systems  
for Ø 2,7 mm  
telescopes  
(FL 187 mm)**

**12 - 13**

**III**

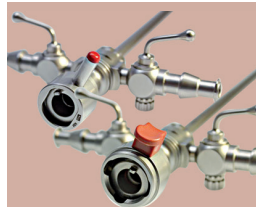

**Sheath systems  
for Ø 2,7 mm  
telescopes  
(FL 110 mm)**

**14 - 15**

**IV**

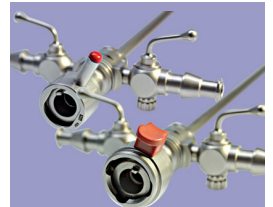

**Sheath systems  
for Ø 1,9 mm  
telescopes  
(FL 60 mm)**

**16 - 17**



**We reserve the right to technical modifications.**



**Quick Lock**





**V**



**STELLA-punches**

**18 - 28**

**VI**

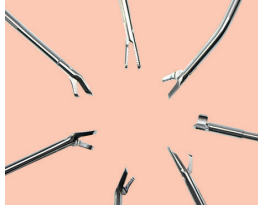

**STELLA-graspers**

**29 - 31**

**VII**

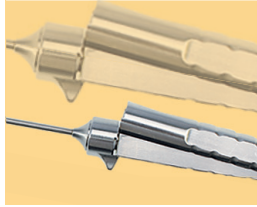

**STELLA-instruments with rotating function**

**32 - 33**

**VIII**



**STELLA-small joint punches and graspers**

**34 - 35**

**IX**

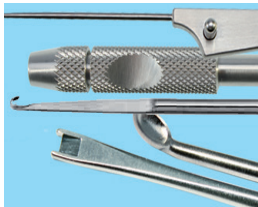

**Instruments for adaptable and triangular handles**

**36 - 41**

**X**



**Monopolar needles and knife electrodes**

**42 - 43**

**XI**

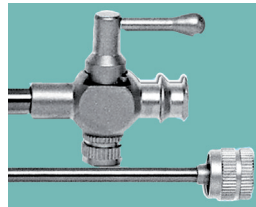

**Rinsing cannulas**

**44**

**XII**



**Light guide cables**

**45**



**recommended telescopes**



**function length**



**Sheath version explanation | *Distal version***

**Sheath tip universal**  
for use of 0°/30°/45°/70° telescopes

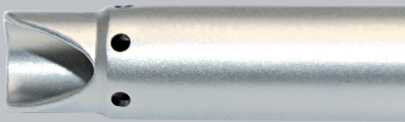

**Sheath tip 30°**  
only for 30° telescopes  
maximum protection of 30° telescope

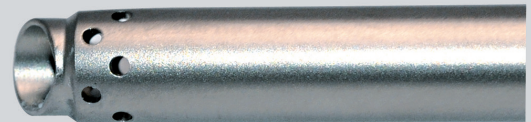

**Conical blunt trocar**



**Pyramidal trocar**



**Conical trocar**



**Trocar with bead**  
centering of the telescopes; no tapering needed;  
**HIGH FLOW**



**Colour code**

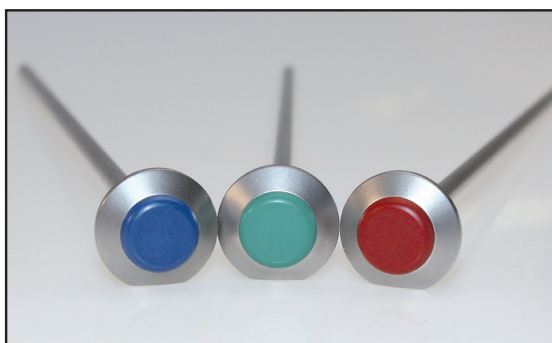

**The Quick Lock connection system**

The main feature of the Quick Lock connecting systems is that the sheath which is rigidly coupled with the connecting system can be very easily assembled and disassembled. Due to the spring locking the centering of inner and outer sheaths is optimized compared to the established Bayonet-type instruments. The precise labeling on the instruments makes it easy to operate the connecting system. Compared to the long time established Bayonet-type of connection the Quick Lock system is characterized by a smooth running take apart and tight sealing of the sheath telescope connection.



Sheath version explanation | *Proximal version*

**One fixed stopcock**

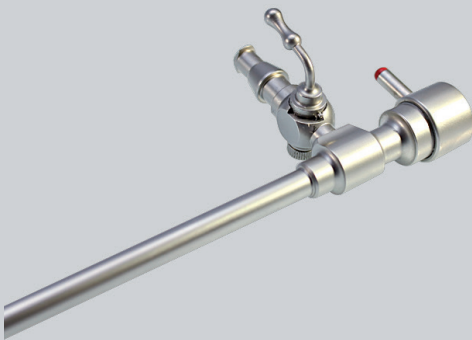

**Two fixed stopcocks**

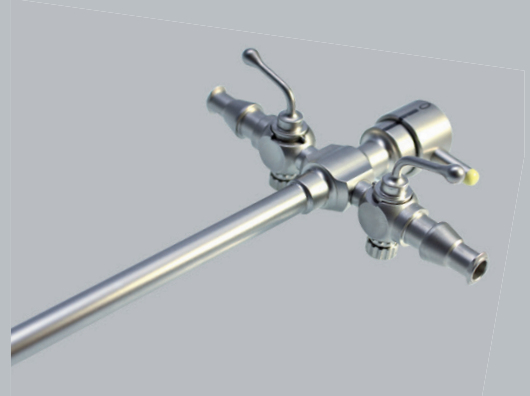

**One rotating stopcock**

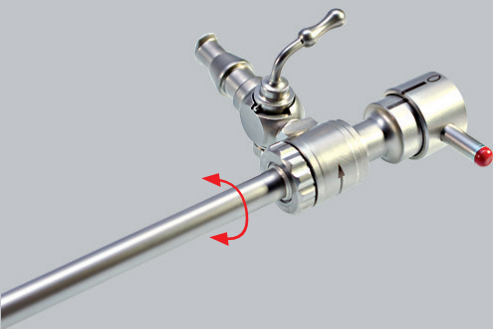

**Two rotating stopcocks**

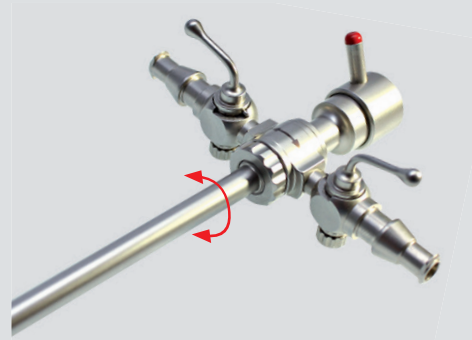

**Standard telescope connection**



**Quick Lock telescope connection**

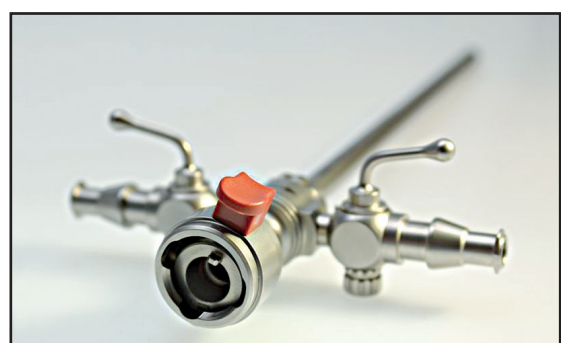



**Arthroscopy telescopes suitable for HD-SYSTEMS;  
 Ø 4,0 mm; FL 175 mm**

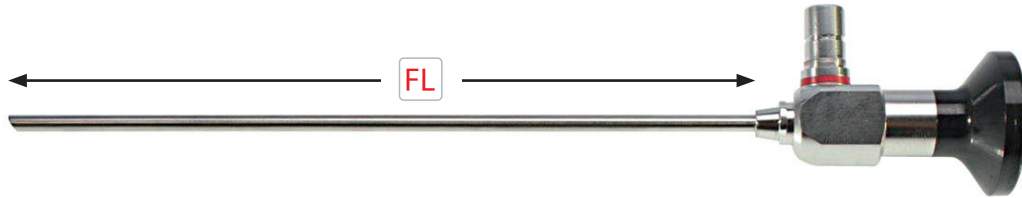

Art.Nr.	Description	Size	Spez
601-204-09	HD-telescope; autoclavable	Ø 4,0 mm; FL 175 mm	0°
			
601-204-39	HD-telescope; autoclavable	Ø 4,0 mm; FL 175 mm	30°
			
601-204-49	HD-telescope; autoclavable	Ø 4,0 mm; FL 175 mm	45°
			
601-204-79	HD-telescope; autoclavable	Ø 4,0 mm; FL 175 mm	70°
			





**Sheath system for telescopes;  
Ø 4,0 mm; FL 175 mm**

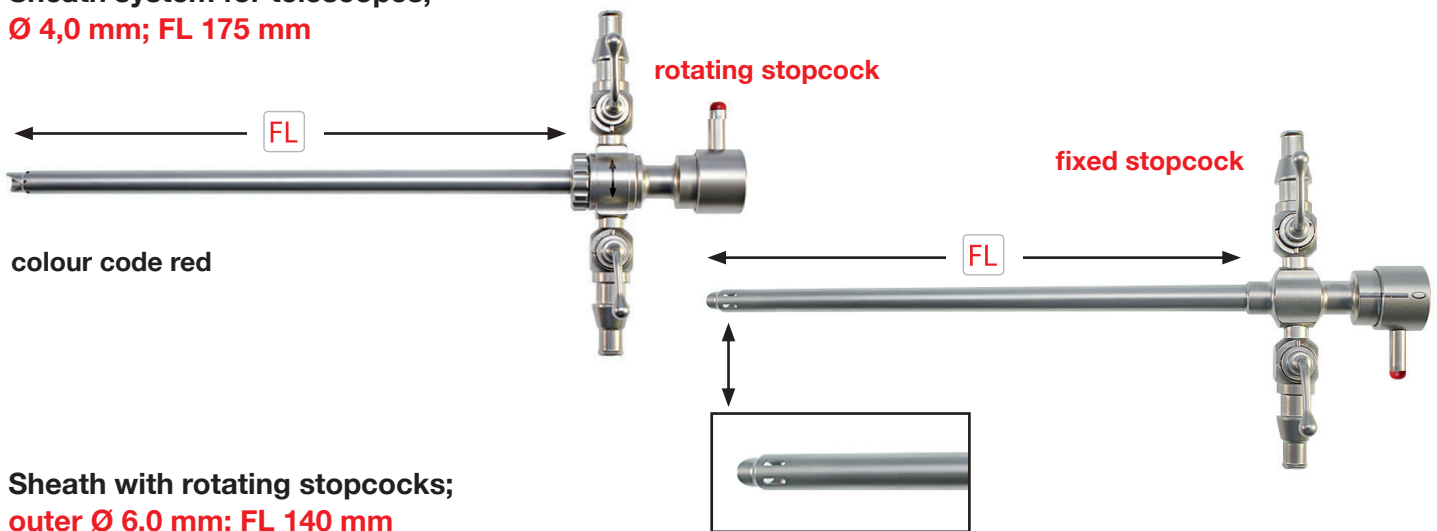

**Sheath with rotating stopcocks;  
outer Ø 6,0 mm; FL 140 mm**

Telescope connection standard	Telescope connection Quick Lock	for direction of view; Ø 4,0 mm; FL 175 mm	Number of rotating stopcocks
650-131-10	650-131-10QL	30°	1
650-131-20	650-131-20QL	30°	2
650-141-10	650-141-10QL	0°/30°/45°/70°	1
650-141-20	650-141-20QL	0°/30°/45°/70°	2



**Sheath with fixed stopcocks;  
outer Ø 6,0 mm; FL 140 mm**

Telescope connection standard	Telescope connection Quick Lock	for direction of view; Ø 4,0 mm; FL 175 mm	Number of fixed stopcocks
650-135-10	650-135-10QL	30°	1
650-135-20	650-135-20QL	30°	2
650-145-10	650-145-10QL	0°/30°/45°/70°	1
650-145-20	650-145-20QL	0°/30°/45°/70°	2



**Trocar;  
for sheaths shown on this page**



Art.Nr.	Description	
650-100-60	pyramidal	
650-100-70	conical blunt	
650-100-80	conical	



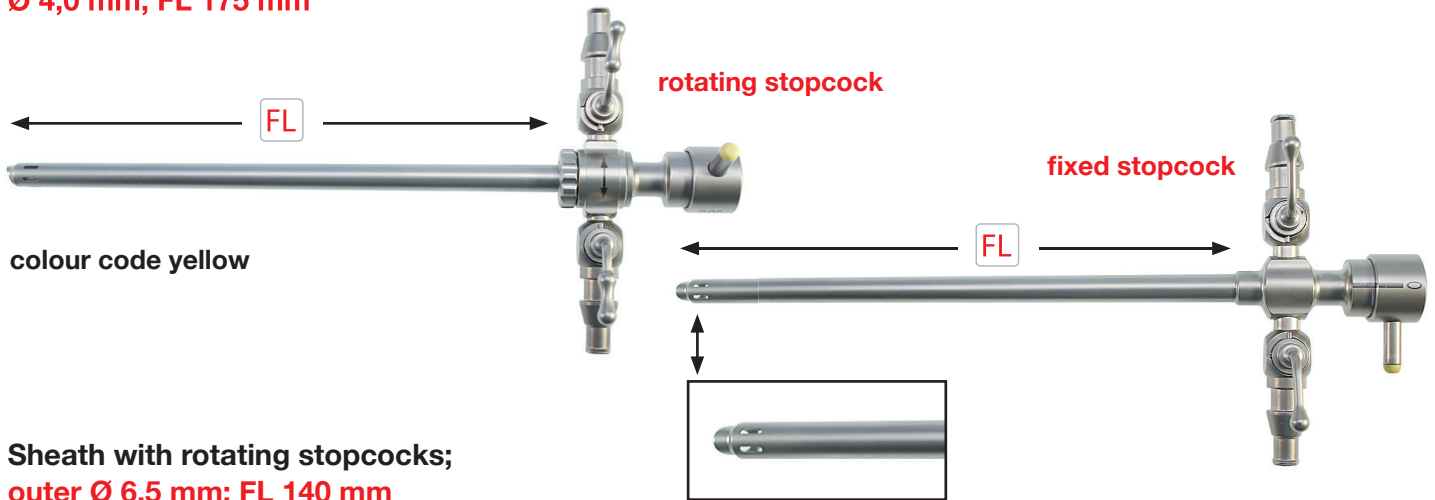

**Sheath system HIGH FLOW for telescopes;  
Ø 4,0 mm; FL 175 mm**

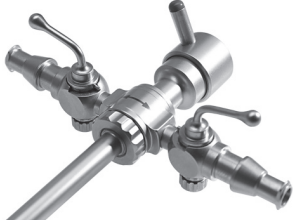

**Sheath with rotating stopcocks;  
outer Ø 6,5 mm; FL 140 mm**





Telescope connection standard	Telescope connection Quick Lock 	for direction of view; Ø 4,0 mm; FL 175 mm	Number of rotating stopcocks	
650-231-20	650-231-20QL	0°/30°/45°/70°	2	

**Sheath with fixed stopcocks;  
outer Ø 6,5 mm; FL 140 mm**

Telescope connection standard	Telescope connection Quick Lock 	for direction of view; Ø 4,0 mm; FL 175 mm	Number of fixed stopcocks	
650-235-20	650-235-20QL	0°/30°/45°/70°	2	

**Trocar;  
for sheaths shown on this page**



Art.Nr.	Description	
650-200-60	pyramidal	
650-200-70	conical blunt	
650-200-80	conical	

Telescopes please see page 8.



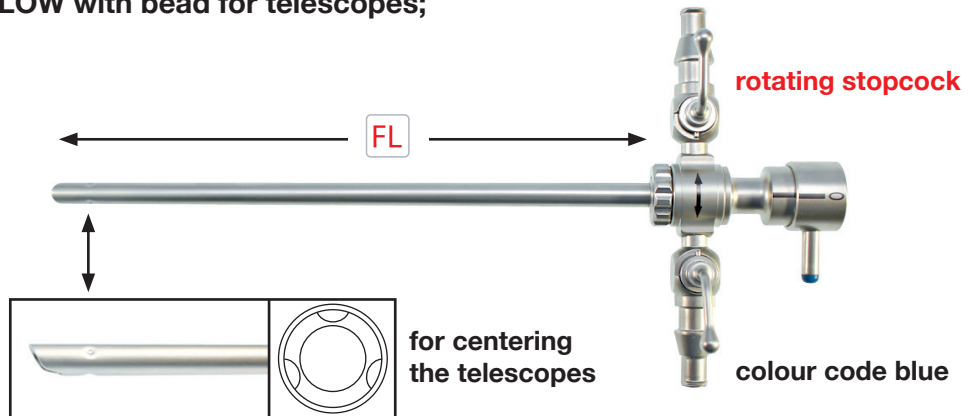

**Sheath system HIGH FLOW with bead for telescopes;  
Ø 4,0 mm; FL 175 mm**

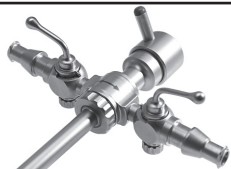

**Sheath with rotating stopcocks;  
outer Ø 6,0 mm; FL 140 mm**

Telescope connection standard	Telescope connection Quick Lock 	for direction of view; Ø 4,0 mm; FL 175 mm	Number of rotating stopcocks	
650-341-10	650-341-10QL	0°/30°/45°/70°	1	
650-341-20	650-341-20QL	0°/30°/45°/70°	2	



**Sheath with fixed stopcocks;  
outer Ø 6,0 mm; FL 140 mm**

Telescope connection standard	Telescope connection Quick Lock 	for direction of view; Ø 4,0 mm; FL 175 mm	Number of rotating stopcocks	
650-345-10	650-345-10QL	0°/30°/45°/70°	1	
650-345-20	650-345-20QL	0°/30°/45°/70°	2	

**Trocar;  
for sheaths shown on this page**



colour code blue

Art.Nr.	Description	
650-300-60	pyramidal	
650-300-70	conical blunt	
650-300-80	conical	

Telescopes please see page 8.



**Arthroscopy telescopes suitable for HD-SYSTEMS;  
 Ø 2,7 mm; FL 187 mm**

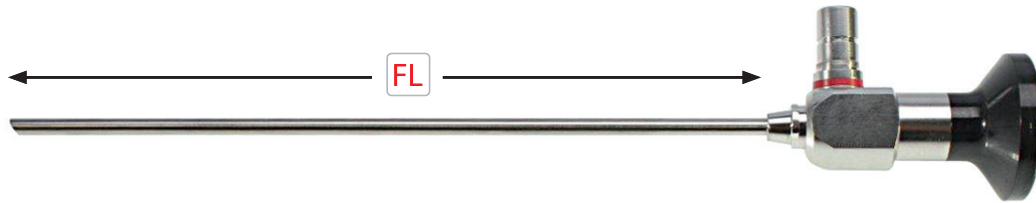

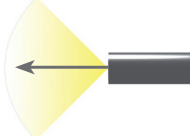
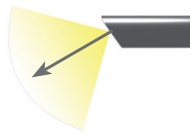
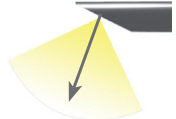

Art.Nr.	Description	Size	Spez.
601-203-09	HD-telescope; autoclavable	Ø 2,7 mm; FL 187 mm	0°
			
601-203-39	HD-telescope; autoclavable	Ø 2,7 mm; FL 187 mm	30°
			
601-203-79	HD-telescope; autoclavable	Ø 2,7 mm; FL 187 mm	70°
			



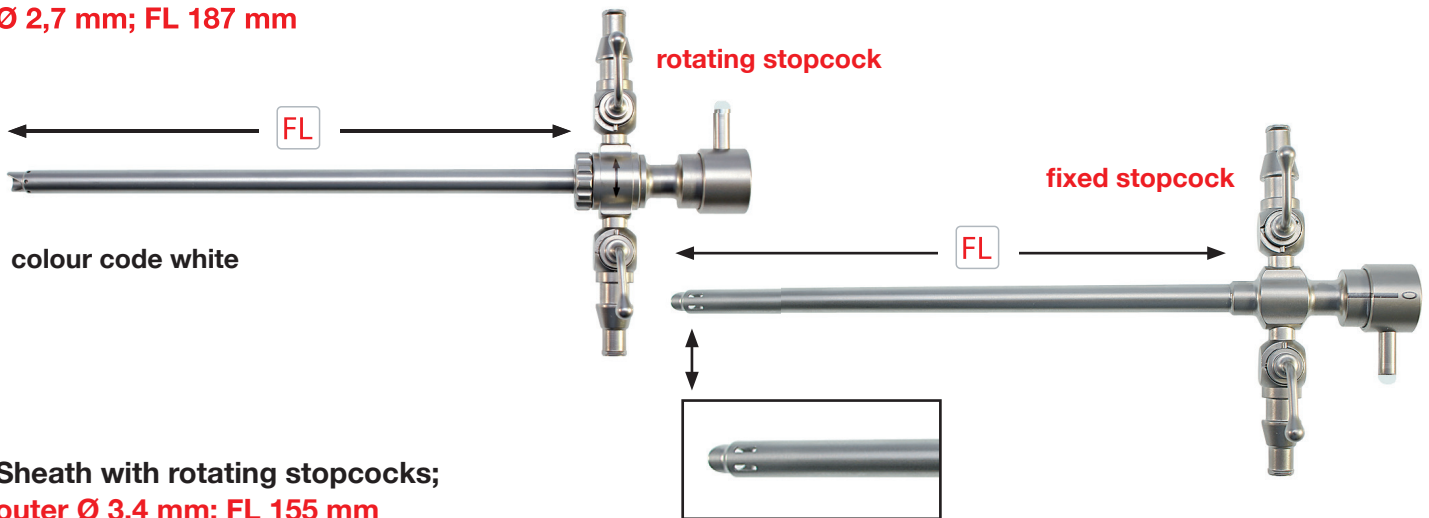

**Sheath system for telescopes;  
Ø 2,7 mm; FL 187 mm**



**Sheath with rotating stopcocks;  
outer Ø 3,4 mm; FL 155 mm**

Telescope connection standard	Telescope connection Quick Lock 	for direction of view; Ø 2,7 mm; FL 187 mm	Number of rotating stopcocks	
650-431-10	650-431-10QL	30°	1	
650-431-20	650-431-20QL	30°	2	
650-441-10	650-441-10QL	0°/30°/45°/70°	1	
650-441-20	650-441-20QL	0°/30°/45°/70°	2	



**Sheath with fixed stopcocks;  
outer Ø 3,4 mm; FL 155 mm**

Telescope connection standard	Telescope connection Quick Lock 	for direction of view; Ø 2,7 mm; FL 187 mm	Number of fixed stopcocks	
650-435-10	650-435-10QL	30°	1	
650-435-20	650-435-20QL	30°	2	
650-445-10	650-445-10QL	0°/30°/45°/70°	1	
650-445-20	650-445-20QL	0°/30°/45°/70°	2	

**Trocar;  
for sheaths shown on this page**



colour code white



Art.Nr.	Description	
650-400-60	pyramidal	
650-400-70	conical blunt	
650-400-80	conical	



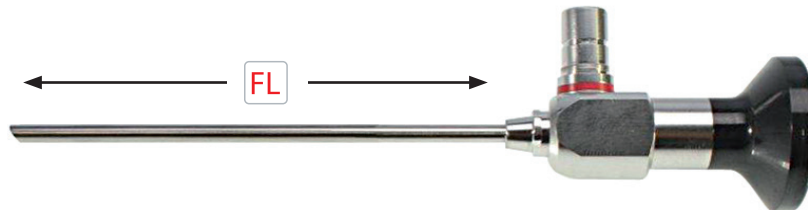

**Arthroscopy telescopes suitable for HD-SYSTEMS;  
 Ø 2,7 mm; FL 110 mm**

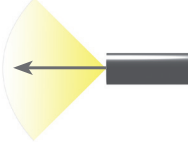
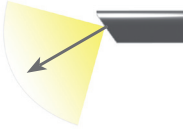

Art.Nr.	Description	Size	Spez.
601-303-09	HD-telescope; autoclavable	Ø 2,7 mm; FL 110 mm	0°
			
601-303-39	HD-telescope; autoclavable	Ø 2,7 mm; FL 110 mm	30°
			
601-303-79	HD-telescope; autoclavable	Ø 2,7 mm; FL 110 mm	70°
			



**Sheath system for telescopes;  
Ø 2,7 mm; FL 110 mm**

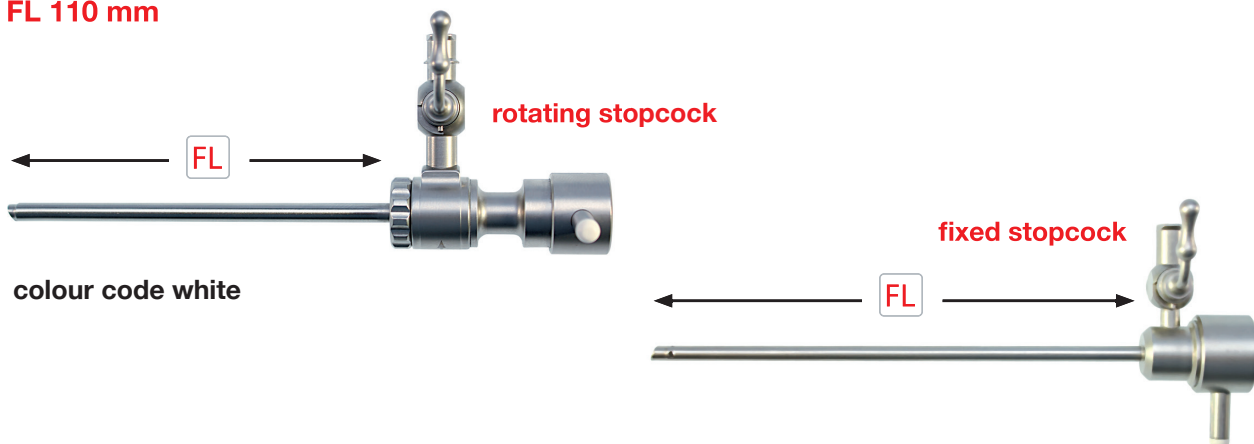

**Sheath with rotating stopcocks;  
outer Ø 3,4 mm; FL 77 mm**



Telescope connection standard	Telescope connection Quick Lock 	for direction of view; Ø 2,7 mm; FL 110 mm	Number of rotating stopcocks
650-531-10	650-531-10QL	30°	1
650-531-20	650-531-20QL	30°	2
650-541-10	650-541-10QL	0°/30°/45°/70°	1
650-541-20	650-541-20QL	0°/30°/45°/70°	2

**Sheath with fixed stopcocks;  
outer Ø 3,4 mm; FL 95 mm**

Telescope connection standard	Telescope connection Quick Lock 	for direction of view; Ø 2,7 mm; FL 110 mm	Number of fixed stopcocks
650-535-10	650-535-10QL	30°	1
650-535-20	650-535-20QL	30°	2
650-545-10	650-545-10QL	0°/30°/45°/70°	1
650-545-20	650-545-20QL	0°/30°/45°/70°	2

**Trocar;  
for sheaths shown on this page**



Art.Nr.	Description	
650-500-60	pyramidal	
650-500-70	conical blunt	
650-500-80	conical	



**Arthroscopy telescopes suitable for HD-SYSTEMS;  
 Ø 1,9 mm; FL 60 mm**

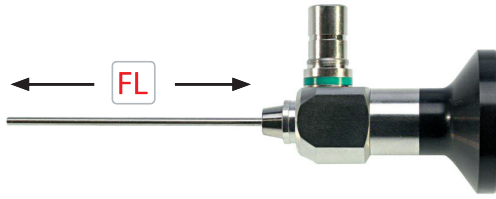

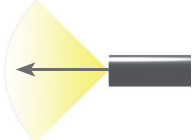
Art.Nr.	Description	Size	Spez.
601-122-09	HD-telescope; autoclavable	Ø 1,9 mm; FL 60 mm	0°
			
601-122-39	HD-telescope; autoclavable	Ø 1,9 mm; FL 60 mm	30°
			



**Sheath system for telescopes;  
Ø 1,9 mm; FL 60 mm**

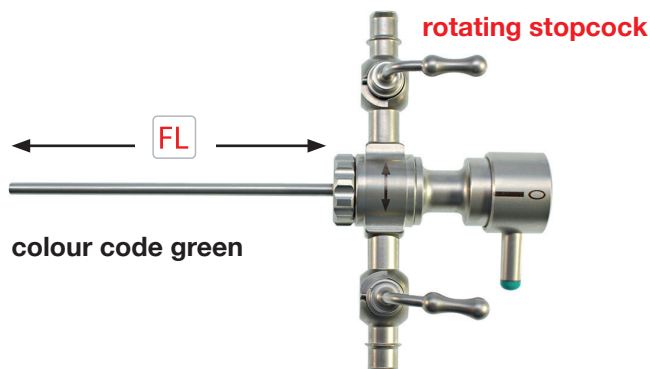



**Sheath with rotating stopcocks;  
outer Ø 2,5 mm; FL 37 mm**

Telescope connection standard	Telescope connection Quick Lock 	for direction of view; Ø 1,9 mm; FL 60 mm	Number of rotating stopcocks
650-631-10	650-631-10QL	30°	1
650-631-20	650-631-20QL	30°	2
650-661-10	650-661-10QL	0°	1
650-661-20	650-661-20QL	0°	2



**Trocar;  
for sheaths shown on this page**



Art.Nr.	Description	
650-600-60	pyramidal	
650-600-70	conical blunt	



**STELLA-Arthroscopy-instruments | *Handle versions***

**Standard handle**



**Standard handle with locking**



**AXIAL handle with locking;  
rotating function**



**Standard handle;  
rotating function**















**STELLA-Arthroscopy-instruments | *Sheath versions***

**Sheath version**

← FL 130 mm →

- straight  direct access
- curved left 12°  designed for the access of posterior and anterior meniscus
- curved right 12°  optimized to the contour of the condyle
- curved up 15°  optimized to the contour of the condyle
- curved down 15°  optimized to the contour of the condyle
- upbiter straight  increase the access to the posterior meniscus
- upbiter curved left 12°  increase the access to the posterior meniscus
- upbiter curved right 12°  increase the access to the posterior meniscus
- upbiter curved up 15°  increase the access to the posterior meniscus

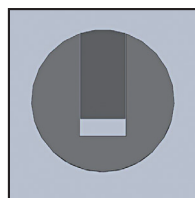

Stella sliding sheath profile

**Small joint;  
shorter sheath lower profile tips**

← FL 85 mm →

- straight 





**STELLA-punches**

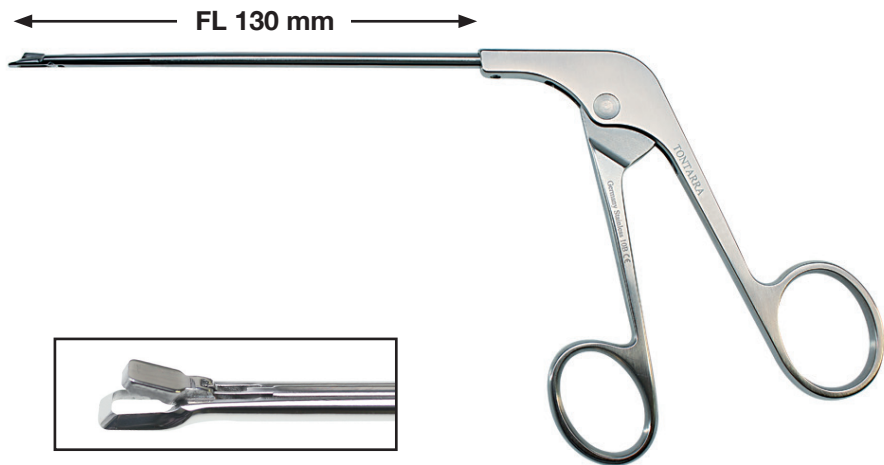

**Wide punch low profile;  
straight**

Art. Nr.	Description	Sheath versions	Tip profile	Bite wide	Jaw wide
578-010-00	straight; small		1,90 mm	2,50 mm	4,10 mm
578-020-00	straight; medium		1,90 mm	3,20 mm	5,00 mm
578-021-00	straight; large		1,90 mm	4,50 mm	6,10 mm
578-035-03	curved left 12°; medium		1,90 mm	3,20 mm	5,00 mm
578-040-04	curved right 12°; medium		1,90 mm	3,20 mm	5,00 mm
578-030-02	curved up 15°; medium		1,90 mm	3,20 mm	5,00 mm

**Wide punch low profile;  
upbiter**



Art. Nr.	Description	Sheath versions	Tip profile	Bite wide	Jaw wide
578-015-10	upbiter straight; small		1,90 mm	2,50 mm	4,10 mm
578-025-10	upbiter straight; medium		1,90 mm	3,20 mm	5,00 mm
578-021-10	upbiter straight; large		1,90 mm	4,50 mm	6,10 mm
578-035-13	upbiter curved left 12°; medium		1,90 mm	3,20 mm	5,00 mm
578-035-14	upbiter curved right 12°; medium		1,90 mm	3,20 mm	5,00 mm
578-035-12	upbiter curved up 15°; medium		1,90 mm	3,20 mm	5,00 mm



**STELLA-punches**

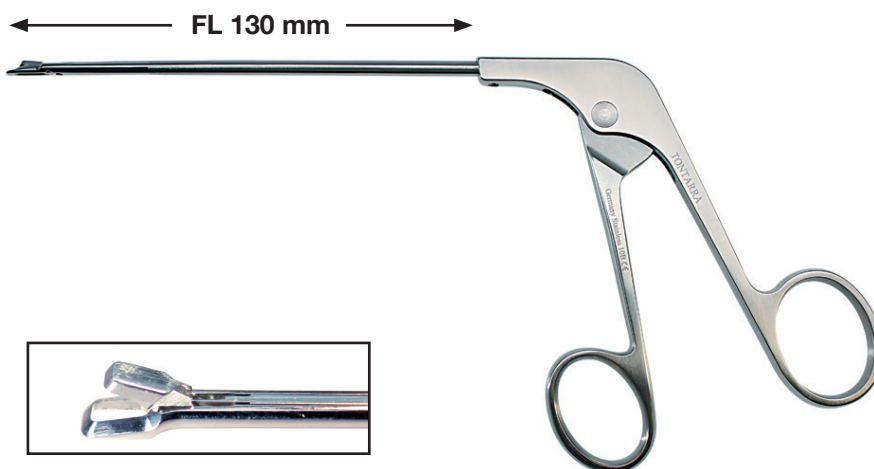

Wide punch standard profile;  
**straight**

Art. Nr.	Description	Sheath versions	Tip profile	Bite wide	Jaw wide
578-110-00	straight; small		2,50 mm	2,50 mm	4,10 mm
578-120-00	straight; medium		2,50 mm	3,20 mm	5,00 mm
578-145-00	straight; large		2,50 mm	4,50 mm	6,10 mm
578-135-03	curved left 12°; medium		2,50 mm	3,20 mm	5,00 mm
578-140-04	curved right 12°; medium		2,50 mm	3,20 mm	5,00 mm
578-130-02	curved up 15°; medium		2,50 mm	3,20 mm	5,00 mm

Wide punch standard profile;  
**upbiter**



Art. Nr.	Description	Sheath versions	Tip profile	Bite wide	Jaw wide
578-115-10	upbiter straight; small		2,50 mm	2,50 mm	4,10 mm
578-125-10	upbiter straight; medium		2,50 mm	3,20 mm	5,00 mm
578-150-10	upbiter straight; large		2,50 mm	4,50 mm	6,10 mm
578-135-13	upbiter curved left 12°; medium		2,50 mm	3,20 mm	5,00 mm
578-140-14	upbiter curved right 12°; medium		2,50 mm	3,20 mm	5,00 mm
578-130-12	upbiter curved up 15°; medium		2,50 mm	3,20 mm	5,00 mm



**STELLA-punches**

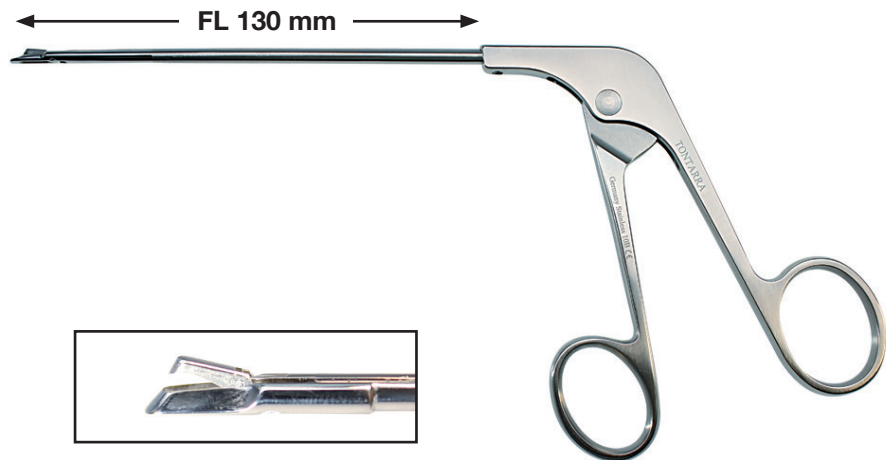

**Basket punch;  
slim straight**



Art. Nr.	Description	Sheath versions	Tip profile	Bite wide	Jaw wide
578-210-00	straight		1,90 mm	1,70 mm	2,90 mm
578-215-10	curved up 15°		1,90 mm	1,70 mm	2,90 mm
578-210-30	45° tip left		1,90 mm	1,70 mm	2,90 mm
578-210-40	45° tip right		1,90 mm	1,70 mm	2,90 mm

**Basket punch;  
slim upbiter**



Art. Nr.	Description	Sheath versions	Tip profile	Bite wide	Jaw wide
578-210-10	upbiter straight		1,90 mm	1,70 mm	2,90 mm
578-220-13	upbiter curved left 12°		1,90 mm	1,70 mm	2,90 mm
578-225-14	upbiter curved right 12°		1,90 mm	1,70 mm	2,90 mm



**STELLA-punches**

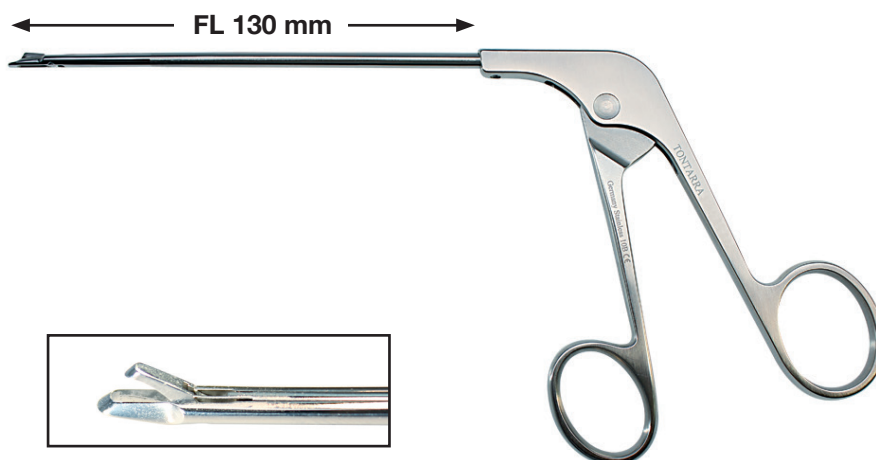

**Basket punch;  
scoop style**

Art. Nr.	Description	Sheath versions	Tip profile	Bite wide	Jaw wide
578-310-00	straight; small		2,10 mm	1,60 mm	3,30 mm
578-350-00	straight; medium		2,30 mm	1,80 mm	3,60 mm
578-355-00	straight; large		2,90 mm	2,00 mm	3,80 mm
578-365-03	curved left 12°; small		2,10 mm	1,60 mm	3,30 mm
578-370-04	curved right 12°; small		2,10 mm	1,60 mm	3,30 mm
578-320-02	curved up 15°; small		2,10 mm	1,60 mm	3,30 mm
578-360-05	curved down 15°; small		2,10 mm	1,60 mm	3,30 mm
578-335-00	straight; medium		2,30 mm	1,60 mm	3,30 mm

**Basket punch;  
scoop style upbiter**



Art. Nr.	Description	Sheath versions	Tip profile	Bite wide	Jaw wide
578-315-10	upbiter straight; small		2,10 mm	1,60 mm	3,30 mm
578-340-10	upbiter straight; medium		2,30 mm	1,60 mm	3,90 mm
578-325-13	upbiter curved left 12°; small		2,10 mm	1,60 mm	3,30 mm
578-330-14	upbiter curved right 12°; small		2,10 mm	1,60 mm	3,30 mm
578-345-02	upbiter curved up 15°; medium		2,30 mm	1,60 mm	3,90 mm





**STELLA-punches**

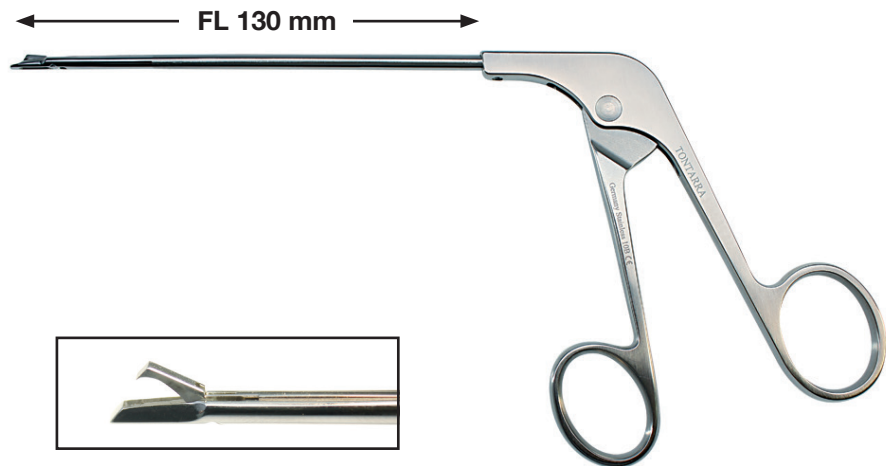

**Hook punch blunt nose;  
straight**

Art. Nr.	Description	Sheath versions	Tip profile	Bite wide	Jaw wide
578-380-00	straight		1,80 mm	1,70 mm	3,30 mm
578-380-03	curved left 12°		1,80 mm	1,70 mm	3,30 mm
578-380-04	curved right 12°		1,80 mm	1,70 mm	3,30 mm
578-380-02	curved up 15°		1,80 mm	1,70 mm	3,30 mm

**Basket punch posterior;  
straight**



Art. Nr.	Description	Sheath versions	Tip profile	Bite wide	Jaw wide
578-385-00	straight		2,50 mm	2,20 mm	4,00 mm
578-385-03	curved left 12°		2,50 mm	2,20 mm	4,00 mm
578-385-04	curved right 12°		2,50 mm	2,20 mm	4,00 mm
578-385-02	curved up 15°		2,50 mm	2,20 mm	4,00 mm

**Basket punch posterior;  
upbiter**



Art. Nr.	Description	Sheath versions	Tip profile	Bite wide	Jaw wide
578-385-10	upbiter straight		2,50 mm	2,20 mm	4,00 mm



**STELLA-punches**

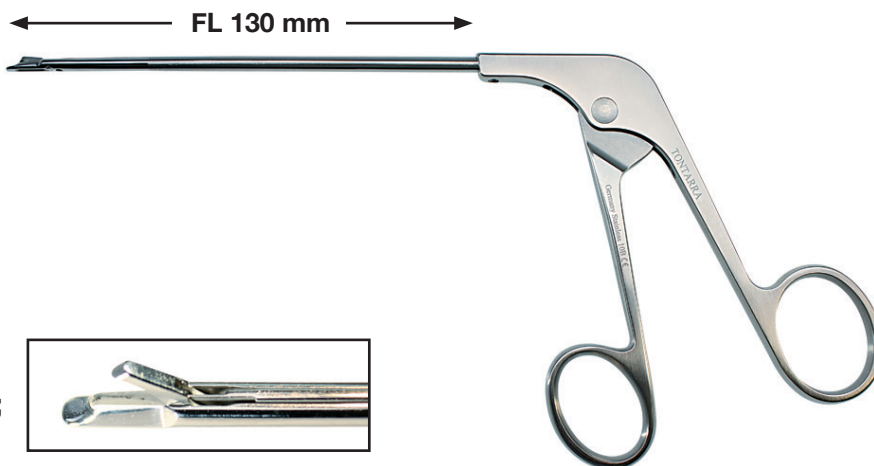

**Basket punch with meniscal lift;  
straight**



Art. Nr.	Description	Sheath versions	Tip profile	Bite wide	Jaw wide
578-390-00	straight		2,50 mm	1,60 mm	3,20 mm

**Basket punch with meniscal lift;  
upbiter**



Art. Nr.	Description	Sheath versions	Tip profile	Bite wide	Jaw wide
578-395-10	upbiter straight		2,50 mm	1,60 mm	3,20 mm

**Wide punch with meniscal lift;  
straight**







Art. Nr.	Description	Sheath versions	Tip profile	Bite wide	Jaw wide
578-397-00	straight		2,50 mm	3,20 mm	5,00 mm

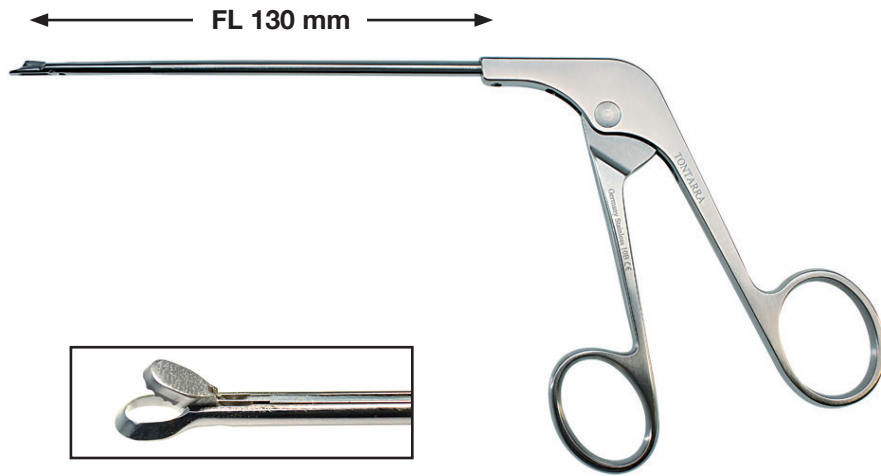

**STELLA-punches**







**Oval punch;  
straight**

Art. Nr.	Description	Sheath versions	Tip profile	Bite wide	Jaw wide
578-410-00	straight		1,65 mm	4,40 mm	6,60 mm
578-425-03	curved left 12°		1,65 mm	4,40 mm	6,60 mm
578-430-04	curved right 12°		1,65 mm	4,40 mm	6,60 mm
578-420-02	curved up 15°		1,65 mm	4,40 mm	6,60 mm

**Oval punch;  
upbiter**



Art. Nr.	Description	Sheath versions	Tip profile	Bite wide	Jaw wide
578-415-10	upbiter straight		1,65 mm	4,40 mm	6,60 mm
578-415-13	upbiter curved left 12°		1,65 mm	4,40 mm	6,60 mm
578-415-14	upbiter curved right 12°		1,65 mm	4,40 mm	6,60 mm
578-415-12	upbiter curved up 15°		1,65 mm	4,40 mm	6,60 mm



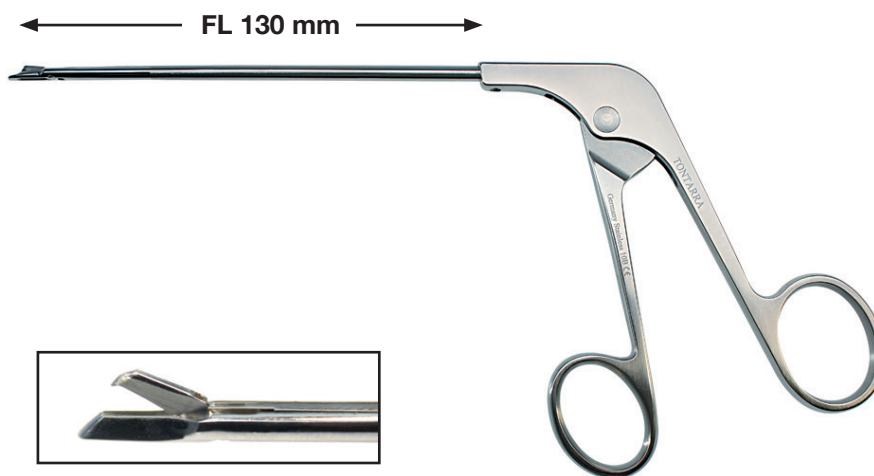

**STELLA-punches**



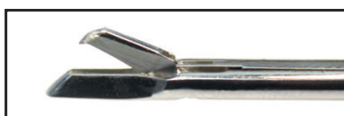



**Scissors punch;  
straight**

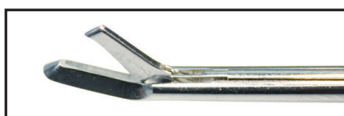

Art. Nr.	Description	Sheath versions	Tip profile	Bite wide	Jaw wide
578-510-00	straight		2,80 mm	1,00 mm	2,50 mm
578-510-03	curved left 12°		2,80 mm	1,00 mm	2,50 mm
578-510-04	curved right 12°		2,80 mm	1,00 mm	2,50 mm

**Scissors punch;  
upbiter**





Art. Nr.	Description	Sheath versions	Tip profile	Bite wide	Jaw wide
578-515-10	upbiter straight		2,80 mm	1,00 mm	2,50 mm
578-520-13	upbiter curved left 12°		2,80 mm	1,00 mm	2,50 mm
578-525-14	upbiter curved right 12°		2,80 mm	1,00 mm	2,50 mm

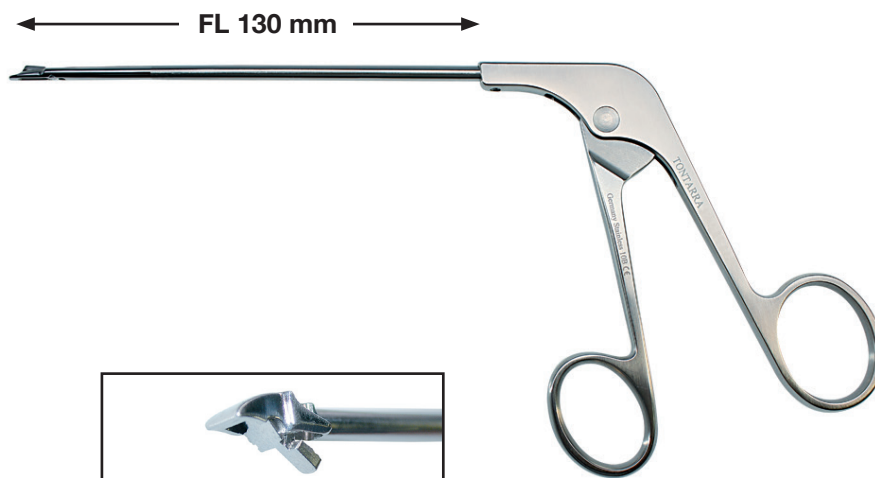

**STELLA-punches**



**Backbiter punch**

Art. Nr.	Description	Sheath versions	Tip profile	Bite wide	Jaw wide
578-555-30	straight; cutting left		3,93 mm	2,38 mm	5,58 mm
578-560-40	straight; cutting right		3,93 mm	2,38 mm	5,58 mm

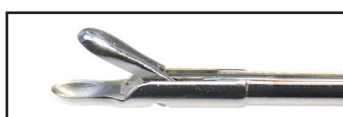

**Rongeur**

Art. Nr.	Description	Sheath versions	Tip profile	Jaw wide
578-725-00	straight		3,70 mm	3,20 mm



**STELLA-graspers**

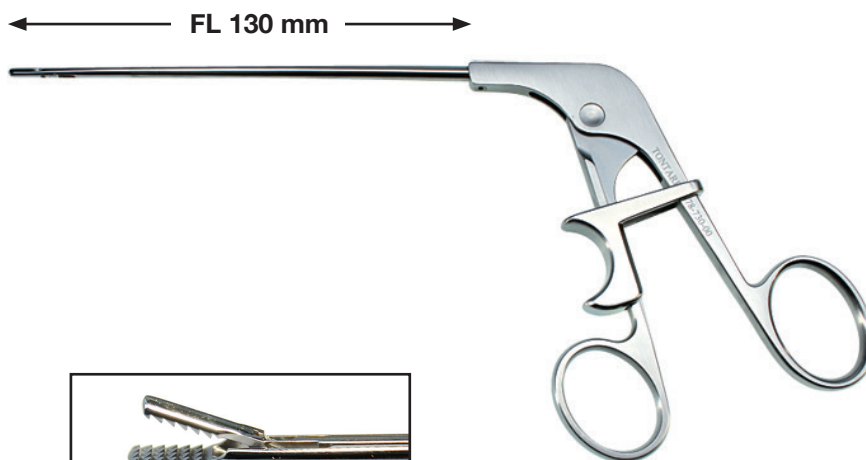

**Grasper Alligator;  
maximum; locking handle**

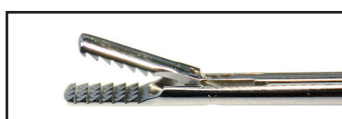

Art. Nr.	Description	Sheath versions	Tip profile	Jaw wide
578-720-00	straight		3,20 mm	3,50 mm
578-720-02	curved up 15°		3,20 mm	3,50 mm

**Grasper Alligator;  
fine; locking handle**

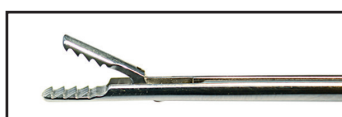

Art. Nr.	Description	Sheath versions	Tip profile	Jaw wide
578-715-00	straight; fine		2,70 mm	3,00 mm
578-715-02	curved up 15°; fine		2,70 mm	3,00 mm



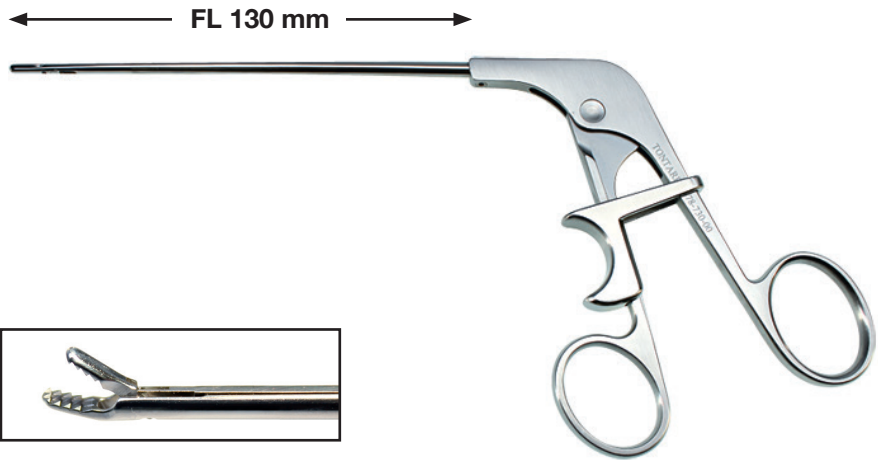

**STELLA-graspers**



**Grasper Alligator;**  
**upbiter fine; locking handle**



Art. Nr.	Description	Sheath versions	Tip profile	Jaw wide
578-715-10	upbiter straight; fine		2,70 mm	3,00 mm
578-715-12	upbiter curved up 15°; fine		2,70 mm	3,00 mm

**Grasper;**  
**1 x 2 teeth; locking handle**



Art. Nr.	Description	Sheath versions	Jaw wide
578-710-00	straight		3,45 mm





**STELLA-graspers**

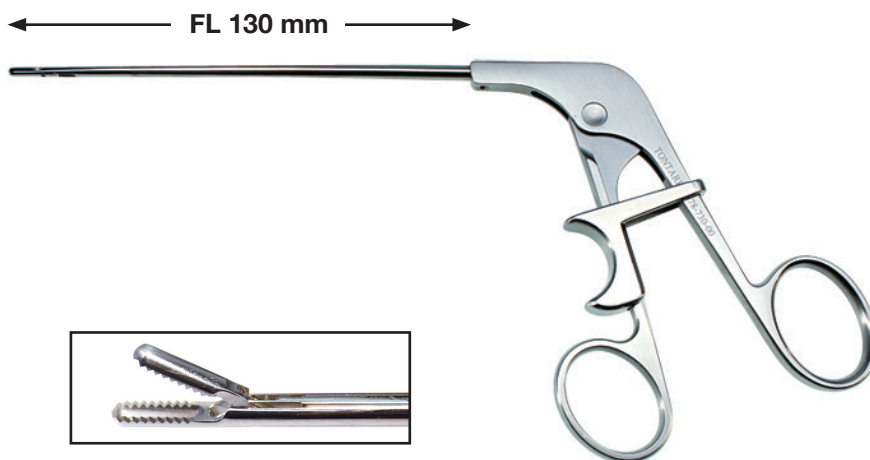

Grasper cupped;  
locking handle

Art. Nr.	Description	Sheath versions	Jaw wide
578-730-00	straight		2,70 mm
578-735-00	straight		3,40 mm

**Meniscus Grasping Forceps**



Art.Nr.	Description	Size	Spez.
573-300-10	meniscus grasping forceps; straight; 1 x 2 teeth		
573-300-20	meniscus grasping forceps; curved left 30°; 1 x 2 teeth		
573-300-30	meniscus grasping forceps; curved right 30°; 1 x 2 teeth		



STELLA-instruments with rotating function | **AXIAL handle**

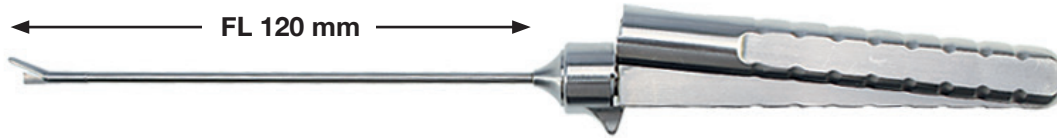

**AXIAL handle with locking;**  
**basket punch 90°**

Art. Nr.	Description	Sheath versions	Bite wide
578-810-30	90° jaw left		2,20 mm
578-815-40	90° jaw right		2,20 mm
578-820-30	90° jaw left		3,40 mm
578-825-40	90° jaw right		3,40 mm



**AXIAL handle with locking;**  
**scissors**

Art. Nr.	Description	Sheath versions
578-910-30	20° scissors jaw left	
578-915-40	20° scissors jaw right	
578-920-30	20° serrated scissors jaw left	
578-925-40	20° serrated scissors jaw right	
578-930-30	60° scissors jaw left	
578-935-40	60° scissors jaw right	



**STELLA-instruments with rotating function | Standard handle**

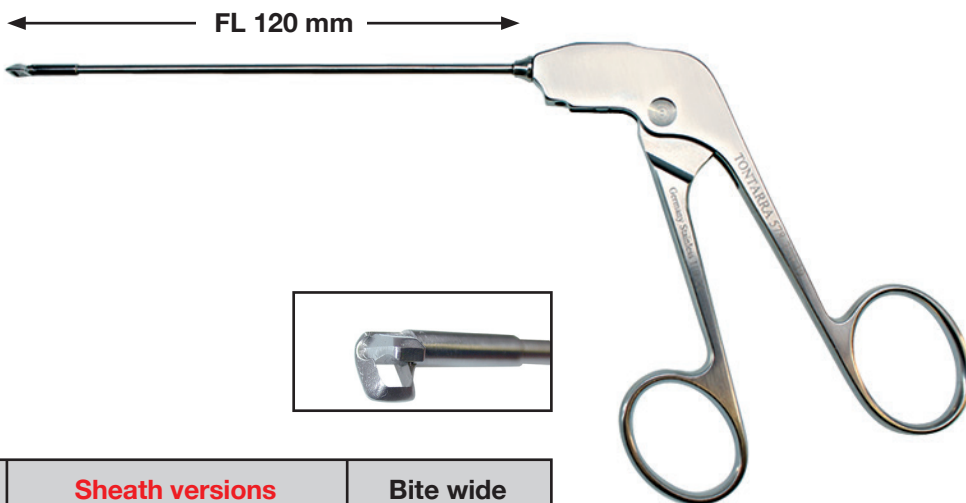

**Standard handle;  
basket punch 90°**

Art. Nr.	Description	Sheath versions	Bite wide
578-810-39	90° jaw left		2,20 mm
578-815-49	90° jaw right		2,20 mm
578-820-39	90° jaw left		3,40 mm
578-825-49	90° jaw right		3,40 mm

**Standard handle;  
scissors**



Art. Nr.	Description	Sheath versions
578-910-39	20° scissors jaw left	
578-915-49	20° scissors jaw right	
578-920-39	20° serrated scissors jaw left	
578-925-49	20° serrated scissors jaw right	
578-930-39	60° scissors jaw left	
578-935-49	60° scissors jaw right	



**STELLA-small joint instruments; punches**

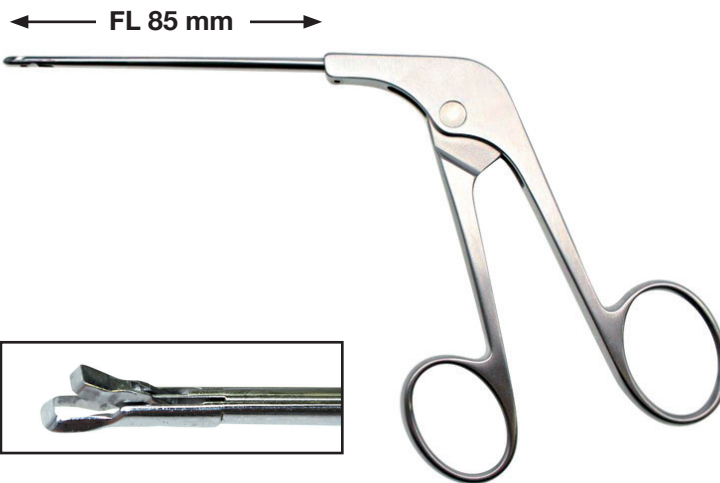

**Wide punch**



Art. Nr.	Description	Sheath versions	Tip profile	Bite wide	Jaw wide
578-990-00	straight		1,60 mm	2,30 mm	3,30 mm

**Blunt nose hook punch**

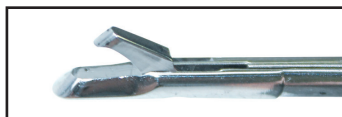

Art. Nr.	Description	Sheath versions	Tip profile	Bite wide	Jaw wide
578-991-00	straight		1,90 mm	1,80 mm	3,80 mm

**Oval punch**



Art. Nr.	Description	Sheath versions	Tip profile	Bite wide	Jaw wide
578-992-00	straight		1,60 mm	2,30 mm	3,60 mm

**Rongeur**

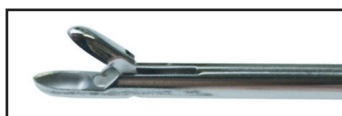

Art. Nr.	Description	Sheath versions	Tip profile
578-993-00	straight		1,90 mm



**STELLA-small joint instruments; graspers;  
with locking handle**

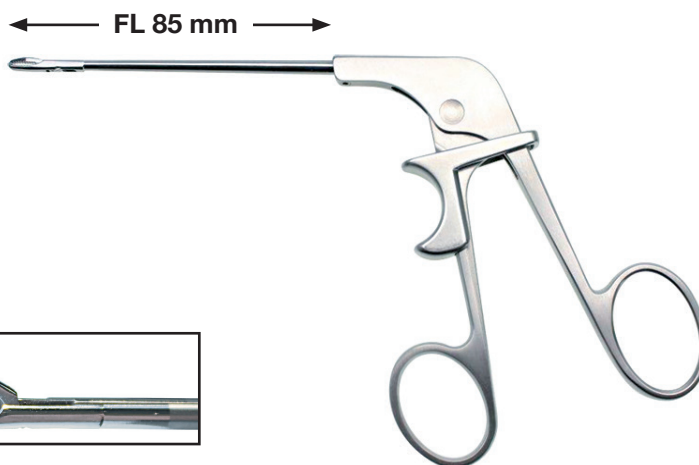

**Grasper Alligator**



Art. Nr.	Description	Sheath versions	Tip profile
578-994-00	straight		2,00 mm

**Grasper;  
1 x 2 teeth**



Art. Nr.	Description	Sheath versions	Tip profile
578-995-00	straight		2,00 mm





**Instruments bits for adaptable handles**

Art.Nr.	Description	Size	Spez.
573-100-00	handle; only		
573-100-05	meniscus hook-probe pointed; bit		
573-100-10	meniscus hook-probe; graduated; bit	2,5 mm	
573-100-15	meniscus hook-probe; graduated; bit	3,5 mm	
573-100-17	meniscus hook-probe; graduated; bit	5,0 mm	
573-100-20	bayonet-knife; bit		
573-100-25	scalpel-knife; bit		
573-100-30	SMILLIE meniscotome; bit	3,0 mm	
573-100-35	SMILLIE meniscotome; bit	5,0 mm	
573-100-40	SMILLIE meniscotome; bit	7,0 mm	

**Bit length 225 mm**



Art.Nr.	Description	Size	Spez.
573-100-45	ring-curette 30°; bit	Ø 3,0 mm	
573-100-47	ring-curette 15°; bit	Ø 5,0 mm	
573-100-50	ring-curette 30°; bit	Ø 7,0 mm	
573-100-55	spoon; 30° curved; bit	Ø 3,0 mm	
573-100-60	banana-knife; smooth; bit		
573-100-65	banana-knife; serrated; bit		
573-100-70	hook-knife; bit	Ø 3,0 mm	
573-100-75	knife 45°; retrograde; bit	Ø 5,0 mm	
573-100-80	sickle-knife; bit		
573-100-85	rosette-knife; toothed; straight; bit		
573-100-90	cartilage-file; fine; bit		
573-100-95	cartilage-file; rough; bit		

Bit length 225 mm







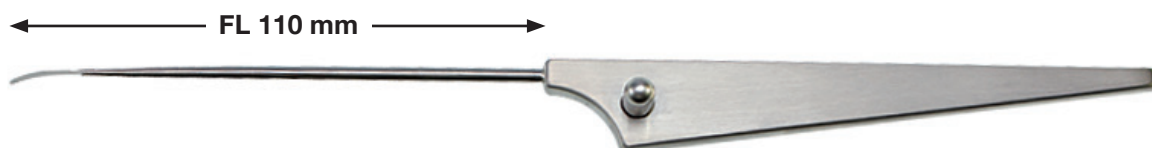



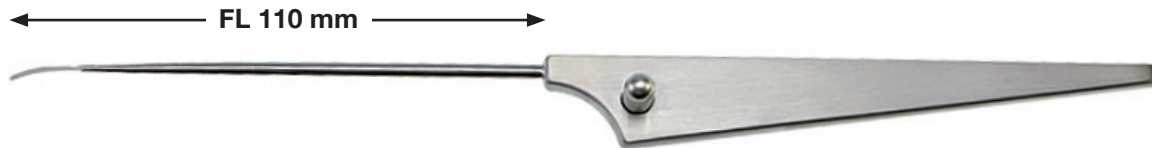



Instruments with **triangular handles**



Art.Nr.	Description	Size	Spez.
573-200-05	meniscus hook-probe; pointed; handle		
573-200-10	meniscus hook-probe; graduated; handle;	3,0 mm	
573-200-15	meniscus hook-probe; graduated; handle	5,0 mm	
573-200-20	bayonet-knife; handle		
573-200-25	scalpel-knife; handle		
573-200-30	SMILLIE meniscotome; handle	3,0 mm	
573-200-35	SMILLIE meniscotome; handle	5,0 mm	
573-200-37	SMILLIE meniscotome; handle	7,0 mm	
573-200-40	ring-curette; 30° curved; handle	3,0 mm	
573-200-42	ring-curette; 15° curved; handle	5,0 mm	
573-200-45	ring-curette; 30° curved; handle	7,0 mm	



Art.Nr.	Description	Size	Spez.
573-200-50	spoon; 30° curved; handle	3,0 mm	
573-200-55	banana-knife; smooth; handle		
573-200-57	banana-knife; serrated; handle		
573-200-60	hook-knife; handle	3,0 mm	
573-200-70	knife 45°; retrograde; toothed; handle		
573-200-75	sickle-knife; handle		
573-200-80	rosette-knife; handle	3,0 mm	
573-200-85	cartilage-file; fine; handle		
573-200-87	cartilage-file; rough; handle		











Instruments with **knurled handle**



Art.Nr.	Description	Size	Spez.
573-150-10	meniscus hook-probe; graduated; handle		3,5 mm
573-150-15	meniscus hook-probe; handle	4,0 mm	
573-150-25	scalpel-knife; handle		
573-150-30	SMILLIE meniscotome; handle	3,0 mm	
573-150-35	SMILLIE meniscotome; handle	5,0 mm	
573-150-37	SMILLIE meniscotome; handle	7,0 mm	
573-150-40	ring-curette; 30° curved; handle	3,0 mm	



<b>Art.Nr.</b>	<b>Description</b>	<b>Size</b>	<b>Spez.</b>
573-150-50	spoon; 30° curved; handle	3,0 mm	
573-150-55	banana-knife; smooth; handle		
573-150-57	banana-knife; serrated; handle		
573-150-60	hook-knife; handle	3,0 mm	
573-150-70	knife 45°; retrograde; handle		
573-150-75	sickle-knife; handle		
573-150-80	rosette-knife; toothed; handle	3,0 mm	
573-150-85	cartilage-file; fine; handle		
573-150-87	cartilage-file; rough; handle		



**Arthroscopic needle electrodes; monopolar;  
Ø 4,0 mm; 90° angled**



Art.Nr.	Description	Size	Spez.
283-035-04	needle electrode with handle; reusable; autoclavable 134°	Ø 0,6 x 1,5 mm; FL 115 mm	
283-040-04	needle electrode with handle; reusable; autoclavable 134°	Ø 0,6 x 4,0 mm; FL 115 mm	
283-050-04	button electrode with handle; reusable; autoclavable 134°	Ø 1,5 x 4,0 mm; FL 115 mm	
283-060-04	needle electrode with handle; reusable; autoclavable 134°	Ø 0,6 x 1,5 mm; FL 170 mm	
283-065-04	needle electrode with handle; reusable; autoclavable 134°	Ø 0,6 x 4,0 mm; FL 170 mm	
283-075-04	button electrode with handle; reusable; autoclavable 134°	Ø 1,5 x 4,0 mm; FL 170 mm	



**Arthroscopic knife electrodes; monopolar**  
 Ø 4,0 mm; 45° angled



Umax: 4 KVp

Art.Nr.	Description	Size	Spez.
283-045-04	knife electrode 45° with handle; reusable; autoclavable 134°	4,0 mm	FL 115 mm
283-070-04	knife electrode 45° with handle; reusable; autoclavable 134°	4,0 mm	FL 170 mm

**Arthroscopic ball electrodes; monopolar**  
 Ø 4,0 mm



Umax: 4 KVp

Art.Nr.	Description	Size	Spez.
283-055-04	ball electrode with handle; reusable; autoclavable 134°	Ø 3,0 mm	FL 115 mm
283-080-04	ball electrode with handle; reusable; autoclavable 134°	Ø 3,0 mm	FL 170 mm



**Rinsing cannulas**

Art.Nr.	Description	Size	Spez.
579-260-00	set cannula for irrigation rinsing; with stopcock (only available as SET)	Ø 3,2 mm	FL 70 mm
	trocar; pyramidal		
	obturator; blunt		
579-270-00	set cannula for irrigation rinsing; with stopcock (only available as SET)	Ø 4,5 mm	FL 70 mm
	trocar; pyramidal		
	obturator; blunt		







**Light guide cables**



Art.Nr.	Description	Size	Spez.
540-805-18	light cable for <b>HALOGEN light</b> source without connectors	Ø 4,8 mm	1800 mm
540-805-23	light cable for <b>HALOGEN light</b> source without connectors	Ø 4,8 mm	2300 mm
540-805-30	light cable for <b>HALOGEN light</b> source without connectors	Ø 4,8 mm	3000 mm
540-803-18	light cable for <b>HALOGEN light</b> source without connectors	Ø 3,5 mm	1800 mm
540-803-23	light cable for <b>HALOGEN light</b> source without connectors	Ø 3,5 mm	2300 mm
540-803-30	light cable for <b>HALOGEN light</b> source without connectors	Ø 3,5 mm	3000 mm
540-815-18	HTT-light cable for <b>XENON light</b> source without connectors	Ø 4,8 mm	1800 mm
540-815-23	HTT-light cable for <b>XENON light</b> source without connectors	Ø 4,8 mm	2300 mm
540-815-30	HTT-light cable for <b>XENON light</b> source without connectors	Ø 4,8 mm	3000 mm
540-813-18	HTT-light cable for <b>XENON light</b> source without connectors	Ø 3,5 mm	1800 mm
540-813-23	HTT-light cable for <b>XENON light</b> source without connectors	Ø 3,5 mm	2300 mm
540-813-30	HTT-light cable for <b>XENON light</b> source without connectors	Ø 3,5 mm	3000 mm

**HTT:** High Transmission Technology

**Light cable connectors**

Art.Nr.	Telescope-side	Art.Nr.	Unit-side
			
540-880-02	Storz 	540-890-02	Storz 
540-880-05	Wolf, clip 	540-890-04	Wolf 
540-880-13	Wolf, snap 		
540-880-01	ACMI/Stryker 	540-890-01	ACMI/ Stryker 

Other adapters on request.



**Index of article numbers**

Art.Nr.	Seite   page	Art.Nr.	Seite   page	Art.Nr.	Seite   page	Art.Nr.	Seite   page
283-035-04	42	573-100-35	36	573-200-37	38	578-140-14	21
283-040-04	42	573-100-40	36	573-200-40	38	578-145-00	21
283-045-04	43	573-100-45	37	573-200-42	38	578-150-10	21
283-050-04	42	573-100-47	37	573-200-45	38	578-210-00	22
283-055-04	43	573-100-50	37	573-200-50	39	578-210-10	22
283-060-04	42	573-100-55	37	573-200-55	39	578-210-30	22
283-065-04	42	573-100-60	37	573-200-57	39	578-210-40	22
283-070-04	43	573-100-65	37	573-200-60	39	578-215-10	22
283-075-04	42	573-100-70	37	573-200-70	39	578-220-13	22
283-080-04	43	573-100-75	37	573-200-75	39	578-225-14	22
540-803-18	45	573-100-80	37	573-200-80	39	578-310-00	23
540-803-23	45	573-100-85	37	573-200-85	39	578-315-10	23
540-803-30	45	573-100-90	37	573-200-87	39	578-320-02	23
540-805-18	45	573-100-95	37	573-300-10	31	578-325-13	23
540-805-23	45	573-150-10	40	573-300-20	31	578-330-14	23
540-805-30	45	573-150-15	40	573-300-30	31	578-335-00	23
540-813-18	45	573-150-25	40	578-010-00	20	578-340-10	23
540-813-23	45	573-150-30	40	578-015-10	20	578-345-02	23
540-813-30	45	573-150-35	40	578-020-00	20	578-350-00	23
540-815-18	45	573-150-37	40	578-021-00	20	578-355-00	23
540-815-23	45	573-150-40	40	578-021-10	20	578-360-05	23
540-815-30	45	573-150-50	41	578-025-10	20	578-365-03	23
540-880-01	45	573-150-55	41	578-030-02	20	578-370-04	23
540-880-02	45	573-150-57	41	578-035-03	20	578-380-00	24
540-880-05	45	573-150-60	41	578-035-12	20	578-380-02	24
540-880-13	45	573-150-70	41	578-035-13	20	578-380-03	24
540-890-01	45	573-150-75	41	578-035-14	20	578-380-04	24
540-890-02	45	573-150-80	41	578-040-04	20	578-385-00	24
540-890-04	45	573-150-85	41	578-110-00	21	578-385-02	24
573-100-00	36	573-150-87	41	578-115-10	21	578-385-03	24
573-100-05	36	573-200-05	38	578-120-00	21	578-385-04	24
573-100-10	36	573-200-10	38	578-125-10	21	578-385-10	24
573-100-15	36	573-200-15	38	578-130-02	21	578-390-00	25
573-100-17	36	573-200-20	38	578-130-12	21	578-395-10	25
573-100-20	36	573-200-25	38	578-135-03	21	578-397-00	25
573-100-25	36	573-200-30	38	578-135-13	21	578-410-00	26
573-100-30	36	573-200-35	38	578-140-04	21	578-415-10	26



**Index of article numbers**

Art.Nr.	Seite   page	Art.Nr.	Seite   page	Art.Nr.	Seite   page	Art.Nr.	Seite   page
578-415-12	26	578-920-39	33	650-135-20	9	650-435-20QL	13
578-415-13	26	578-925-40	32	650-135-20QL	9	650-441-10	13
578-415-14	26	578-925-49	33	650-141-10	9	650-441-10QL	13
578-420-02	26	578-930-30	32	650-141-10QL	9	650-441-20	13
578-425-03	26	578-930-39	33	650-141-20	9	650-441-20QL	13
578-430-04	26	578-935-40	32	650-141-20QL	9	650-445-10	13
578-510-00	27	578-935-49	33	650-145-10	9	650-445-10QL	13
578-510-03	27	578-990-00	34	650-145-10QL	9	650-445-20	13
578-510-04	27	578-991-00	34	650-145-20	9	650-445-20QL	13
578-515-10	27	578-992-00	34	650-145-20QL	9	650-500-60	15
578-520-13	27	578-993-00	34	650-200-60	10	650-500-70	15
578-525-14	27	578-994-00	35	650-200-70	10	650-500-80	15
578-555-30	28	578-995-00	35	650-200-80	10	650-531-10	15
578-560-40	28	579-260-00	44	650-231-20	10	650-531-10QL	15
578-710-00	30	579-270-00	44	650-231-20QL	10	650-531-20	15
578-715-00	29	601-103-00	12	650-235-20	10	650-531-20QL	15
578-715-02	29	601-122-09	16	650-235-20QL	10	650-535-10	15
578-715-10	30	601-122-39	16	650-300-60	11	650-535-10QL	15
578-715-12	30	601-203-09	12	650-300-70	11	650-535-20	15
578-720-00	29	601-203-39	12	650-300-80	11	650-535-20QL	15
578-720-02	29	601-203-79	12	650-341-10	11	650-541-10	15
578-725-00	28	601-204-09	8	650-341-10QL	11	650-541-10QL	15
578-730-00	31	601-204-39	8	650-341-20	11	650-541-20	15
578-735-00	31	601-204-49	8	650-341-20QL	11	650-541-20QL	15
578-810-30	32	601-204-79	8	650-345-10	11	650-545-10	15
578-810-39	33	601-303-09	14	650-345-10QL	11	650-545-10QL	15
578-815-40	32	601-303-39	14	650-345-20	11	650-545-20	15
578-815-49	33	601-303-79	14	650-345-20QL	11	650-545-20QL	15
578-820-30	32	650-100-60	9	650-400-60	13	650-600-60	17
578-820-39	33	650-100-70	9	650-400-70	13	650-600-70	17
578-825-40	32	650-100-80	9	650-400-80	13	650-631-10	17
578-825-49	33	650-131-10	9	650-431-10	13	650-631-10QL	17
578-910-30	32	650-131-10QL	9	650-431-10QL	13	650-631-20	17
578-910-39	33	650-131-20	9	650-431-20	13	650-631-20QL	17
578-915-40	32	650-131-20QL	9	650-431-20QL	13	650-661-10	17
578-915-49	33	650-135-10	9	650-435-10	13	650-661-10QL	17
578-920-30	32	650-135-10QL	9	650-435-10QL	13	650-661-20	17
				650-435-20	13	650-661-20QL	17



· WORLD WIDE DISTRIBUTION NETWORK ·



**TONTARRA Medizintechnik GmbH**

Daimlerstr. 15 · 78573 Wurmlingen/Germany  
Tel: +49(0) 74 61/9 65 76 -0  
Fax: +49(0) 74 61/9 65 76 -26  
info@tontarra.de

[www.tontarra.de](http://www.tontarra.de)

All rights are reserved. Technical alterations are possible. This folder may be used for no other purpose than offering, buying and selling of our products. No part may be copied or reproduced in any form. In the case of misuse, we retain the rights to recall our catalogs and pricelists and to take legal actions.  
999-310-02E · 03.2018