

TONTARRA

ENDOSCOPY

ON THE GENTLE SIDE
OF GYNECOLOGY

GUBBINIoriginal

GUBBINIellipse

GUBBINImidi

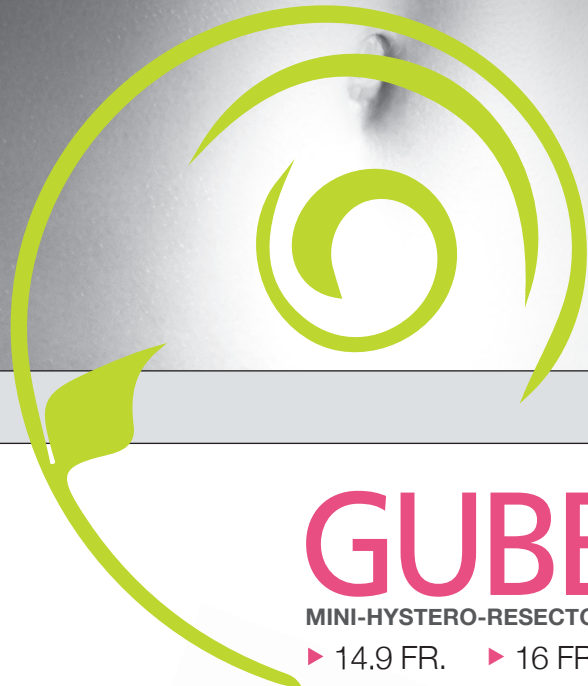

GUBBINI

MINI-HYSTERO-RESECTOSCOPY-SYSTEM

▶ 14.9 FR. ▶ 16 FR. ▶ 18.5 FR.



ABOUT US

For more than 50 years “made by TONTARRA, Germany” is a synonym for state-of-the-art surgical and endoscopic instruments and equipment.

This success and the international recognition of the skillfulness in surgical and endoscopic instrument making of Tontarra Medizintechnik GmbH are based on our commitment to medical innovation, mastery in manufacturing, and a strong focus on our continuing tradition of excellence.

The confidence in our surgical and endoscopic lines as expressed by our international customers, distribution- and OEM-partners are a driving force to face and meet new challenges.

TONTARRA



Indispensable ‘tools’ for maturing new ideas into high-precision surgical instruments of highest precision include our state-of-the-art manufacturing facility and production processes, and especially the comprehensive technical know-how, ingenuity and strong commitment of our entire team.

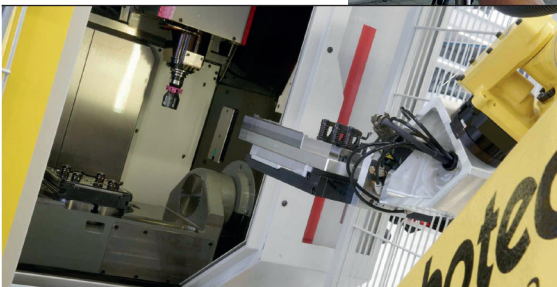
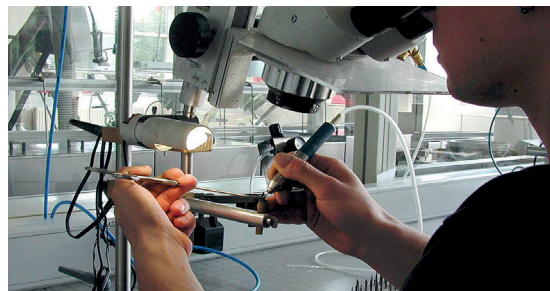

TABLE OF CONTENT

▶ Introduction	3 – 6
▶ Components for the GUBBINI and GUBBINI ELLIPSE SYSTEM	8 – 11
▶ GUBBINI SYSTEM Schematic overview	12 – 13
▶ GUBBINIoriginal	16 – 18
▶ GUBBINIellipse	20 – 24
▶ GUBBINImidi	26 – 28
GUBBINIoriginal GUBBINIellipse GUBBINImidi	
▶ Micro Instruments for hystero- and resctoscopy	30 – 33
▶ GUBBINI SYSTEM Overview by Art.No.'s	34 – 35
▶ Accessories	38 – 40
▶ Paracervical Local Blockade	41
▶ Index	42

THE GUBBINI-SYSTEM:

DEFINING A NEW DIMENSION IN HYSTERO-RESECTOSCOPY

The original GUBBINI-Mini Hystero-Resectoscope with a diameter of 16 French was first introduced in 2010. By now, a full product line with three slightly different hybrid instruments, each of them for mono- or bipolar distension mediums and with a complete range of accessories, has evolved around the “original GUBBINI”.



GUBBINIoriginal

The original GUBBINI System features a 16 French round distal tip/sheath form, the introduction into the cervical canal does not require dilation.



GUBBINIellipse

Recently, sheaths with a distal tip of 14.9 French in elliptic form were added to the Gubbini System-Line: the GUBBINI Ellipse instruments facilitate the introduction without dilation also in stenotic patients.

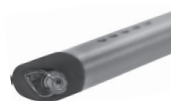

GUBBINImidi

A third instrument set, the GUBBINI midi resectoscope of 18.5 French, is based upon the same innovative technical principles than its smaller siblings. Even though the size requires the dilation of the cervix, the small diameter clearly reduces the strain on patients. The GUBBINI midi features the excellent functionality and handiness of all GUBBINI systems, while the size and form of the loops facilitate the treatment of larger myoma, or more extended intracavitary lesions.

GUBBINI systems 14.9 & 16 French – matching the natural female anatomic conditions

Motivation to downsize the 24/26 French instruments commonly used in vaginoscopic procedures to “no more than 16 French” has been to avoid the painful dilation of the cervix, as well as unnecessary tissue damage.

- ▶ The small size of the sheaths allows the surgeon to perform operative procedures without vaginal instruments (no speculum; no tenaculum; no Hegar’s dilators)
- ▶ Miniature loops and micro instruments are ideally shaped to the given anatomical proportions
- ▶ Easier handling due to the minimized dimensions of the instruments; less weight
- ▶ The risk of intra- and post-operative complications is minimized thanks to the size and shape of instruments

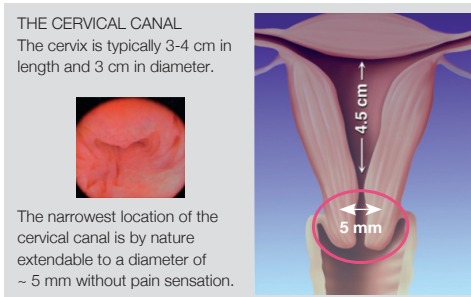

WELCOME TO THE GENTLE SIDE OF GYNECOLOGY ...

The GUBBINI Resectoscopy Systems with 14.9 Fr. and 16 Fr. clearly have the potential to revolutionize current proceedings in minimal invasive gynecology towards a more “gentle” approach with less traumatizing interventions in gynecology.



- ▶ No dilation of the cervical canal necessary
- ▶ Apt for treatment in office setting: It enables the treatment of pathologies which up to date often are still performed under general anesthesia, and/or require hospitalization.
- ▶ Optimization of the “See & Treat” approach: by simply exchanging the diagnostic working sheath with the inner continuous flow resectoscopic sheath – without the need of re-introduction of the outer sheath – diagnostic hysteroscopy and therapeutic resectoscopy can be performed during one single session.
- ▶ The bipolar current mode increases safety by using saline solution as physiologic distension medium (NaCl 0,9%). Other important safety aspects are the reduced risk of intra- and post-operative complications.
- ▶ Cost minimization (shorter operating times, less anesthesia, less complication risk, less hospitalization).

RESULTS FROM CLINICAL STUDIES ARE:

- ▶ Shorter operation times in comparison to conventional 24/26 Fr. systems and other small instrument systems of competitors¹.
- ▶ Significantly less pain sensation – measured by VAS (Visual Analog Scale), even if compared to treatments under anesthesia with standard systems^{1,2}.
- ▶ Progressive learning curve: The intuitive system enables surgeons to improve their technique by experience. To master the system, usually thirty procedures are required until a fast and nearly painless operation can be performed².
- ▶ Optimally adjusted electrodes – even 90° resections are possible, despite the small diameters of the resectoscopic sheaths².

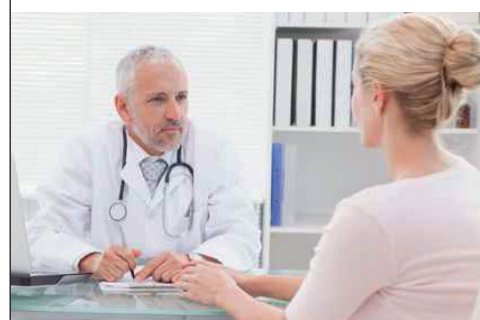

Contemporary Gynecology has generally shifted towards gentler treatment methods, and communication on eye-level between doctor and patient has gained importance.

CLINICAL VALIDATIONS:

¹ *Using a 16-French resectoscope as an alternative device in the treatment of uterine lesions: a randomized controlled trial.*
Ricciardi R, Lanzone A, Tagliaferri V, Di Florio C, Ricciardi L, Selvaggi L, Guido M.;
Source: Obstetrics and Gynecology; Date of publication: 2012 July; 120(1):160-5.

² *Feasibility and Acceptability of Office-Based Polypectomy with a 16F Mini-Resectoscope: A Multicenter Clinical Study.*
Dealberti D, Riboni F, Cosma S, Pisani C, Montella F, Saitta S, Calagna G, Di Spiezio Sardo A. J Minimal Invasive Gynecology;
Date of publication: 2016 Mar-Apr; 23(3): 418-24.

WIDE SPECTRUM OF INDICATIONS

The versatile GUBBINI instruments can be applied to nearly all standard endo-uterine procedures and could replace common hysteroscopes widely used in outpatient 5 mm surgery.

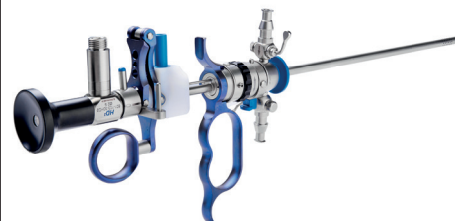

Its extraordinary successful performance in polypectomy and myomectomy has been shown in clinical validations; the system even provides miniature preparation loops for the cold myoma enucleation technique (G1, G2 Myoma).

The GUBBINI SYSTEM is also used on indications difficult to treat, like Asherman syndrome, Isthmocele, resectoscopic procedures inside the cervical canal, or lesions situated in difficult positions.

What matters to the PATIENT about the Mini-Hystero-Resectoscope:

- ▶ Her surgery is as atraumatic as a gynecologic intervention can be
- ▶ She does not necessarily need anesthetics
- ▶ It allows her to go home right after an intervention for which she otherwise maybe would have to stay overnight

Recommended therapeutic and diagnostic options by Prof. Gubbini:

CERVICAL CANAL
Endocervical Polypectomy (upper, medium and lower third, ectocervical)

Targeted biopsy in case of unclear endocervical diagnosis

Hysteroscopic treatment of Isthmocele
Synechiolysis

UTERUS CAVITY
Biopsy of suspicious endometrial lesions

Polypectomy

Metroplasty: Hysteroscopic treatment of uterine malformations (f.e. Uterine Septum, Bicornuate Uterus)

Metrorrhagia/Abnormal Uterine Bleeding

Myomectomy (< 3 cm / 1.2 inch)

Endometrial ablation

Isthmocele

Asherman Syndrome

DR. GIAMPIETRO GUBBINI



- At present** Practicing gynecologist, tutor und consultant for different competence centers in Italy and several countries in Europe, guest lecturing and workshops about the GUBBINI System at different institutions. Member and head of the scientific commission of the Italian Society for Gynecological Endoscopy (SEGi).
- since 2001** Chairman of the commission for accreditation of the Society for Gynecological Endoscopy (SEGi) and consultant gynecologic endoscopist at various public and private health institutions.
- since 1991** Senior counselor of the Italian Society for Gynecological Endoscopy and Laser Therapy (S.I.E.L.G.).
- 1981-1991** Head Doctor of the Gynecologic Endoscopy Unit, Department of Obstetrics at the University Hospital S. Orsola Malpighi, Bologna University.
- 1976-1981** University Hospital S. Orsola Malpighi, Bologna University. Specialist in Gynecology and Obstetrics.
- 1976** Specialist degree in Gynecology and Obstetrics: University of Bologna.
- 1972** University degree in Medical Science (M.D.): University of Bologna.

SCIENTIFIC ACHIEVEMENTS/ PUBLICATIONS

Associate professor and tutor of hysteroscopic surgery in numerous medical institutions

Founder of 'ME-stop' centers for minimally-invasive treatment of Menorrhagia

Member of the American Association of Gynecologic Laparoscopists (AAGL)

Published more than 200 medical and scientific papers on sterility, oncology, obstetrics and gynecological endoscopy

Master mind and creative force of the 'GUBBINI' Mini-Resectoscope

ON THE GENTLE SIDE
OF GYNECOLOGY



GUBBINI

COMPONENTS FOR
ALL THREE SYSTEMS

GUBBINIoriginal

◀ 16 Fr.

GUBBINIellipse

◀ 14.9 Fr.

GUBBINImidi

◀ 18.5 Fr.



COMPONENTS FOR ALL THREE SYSTEMS

- ▶ GUBBINI working elements & HF-unit

Hybrid working elements for monopolar use or with bipolar current and conductive solution (NaCl 0.9%) in combination with the Mini-Resectoscopes GUBBINI original and the GUBBINI ellipse, or the GUBBINI midi (all article numbers see below).

GUBBINI hybrid working elements:

Light-weight and extremely ergonomic working elements – made with sections of highly resistant titanium.

Safety distance holder, optional.
The distance holder gets located at the working element between the insulating teflon block and the grip.

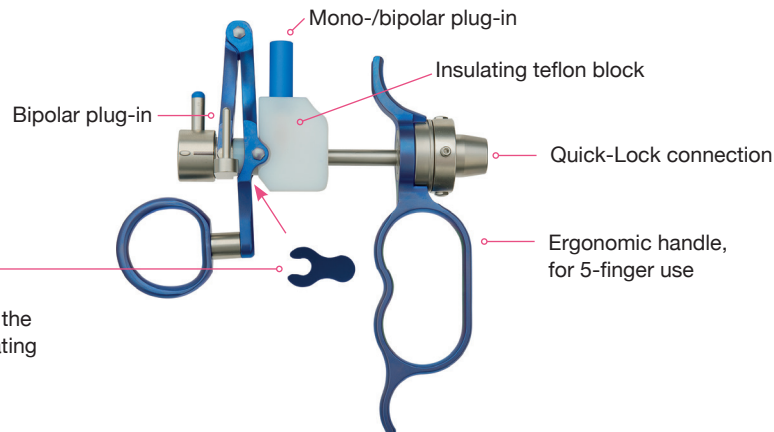

GUBBINI WORKING ELEMENTS

Description	Original/ELLIPSE	MIDI	
For passive cutting / closed handle / with titanium hinge graduated / Quick Lock system / suitable for Ø 2.9 mm 0°; 12° and 30° telescopes	582-150-00GUB	582-180-00B	
Safety distance holder (1.1 mm width) for bipolar working elements / 582-150-00GUB; 582-180-00B; 1 pc.	582-150-02GUB		

HF UNIT AND HF CONNECTION CABLES

HF UNIT PLASMA WAVE

Description	Art. No.	
PWT-400 Plasma Wave; HF generator for electrical surgery	540-280-50	

The GUBBINI-System is compatible with HF devices for monopolar and bipolar saline solution resectoscopes of most common brands. For a cable overview see the the ACCESSORIES section at the end of the catalogue.





COMPONENTS FOR ALL THREE SYSTEMS

- ▶ Ø 2.9 mm telescopes

The „See & Treat“ approach has become a synonyme for office hysteroscopy. This already implies that the image quality is an essential criteria for each hysteroscopist: the clear visualization of a patient’s pathology is not only a prerequisite for secure diagnostics and the choice of intervention, but as well vital for a successful performance of therapeutic treatment.

For recommendations which telescopes to use in hysteroscopy and resectoscopy for each of the GUBBINI systems see the overview on page 34-35.

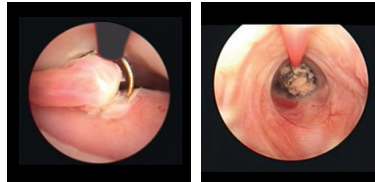

Pictures by Dr. Giampietro Gubbini

Polypectomy performed by TONTARRA’s Mini-Hystero-Resectoscope “GUBBINI”.

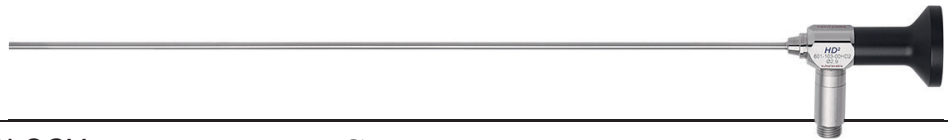

TELESCOPES FOR GYNECOLOGY [autoclavable]

▶ Ø 2.9 mm [also for use in Laparoscopy and Urology]

Description	Art. No.	
TELESCOPE HD+2 ▶ Ø 2.9 mm; 0° FL 300 mm	601-103-00HD2	· Field of view: 80° · Compatible with most instrument- and camera systems
TELESCOPE HD+2 ▶ Ø 2.9 mm; 12° FL 300 mm	601-103-12HD2	
TELESCOPE HD+2 ▶ Ø 2.9 mm; 30° FL 300 mm	601-103-30HD2	



The “TONTARRA telescopes with the PLUS” feature a cutting edge optical technology which result in

- Exceptional brightness
- Brilliant, high contrast images even around the edges
- Optimum color rendering
- Outstanding optical transmission
- Scratch resistant (Sapphires at distal and proximal end)

The telescope body is of stainless steal, providing extra high durability and outstanding autoclavability for spotless hygiene (French cycle validated).

The triple tube design warrants unique bending resistance.

We recommend to use the HD+2 telescopes, which are optimized for 2nd generation & full HD imaging systems.

For further information please refer to our telescope catalogue, or contact us.



COMPONENTS FOR ALL THREE SYSTEMS

- ▶ Micro instrumentation

Most of the micro instruments can be used for all three systems, they are shown in the chapter MICRO INSTRUMENTS (page 30).

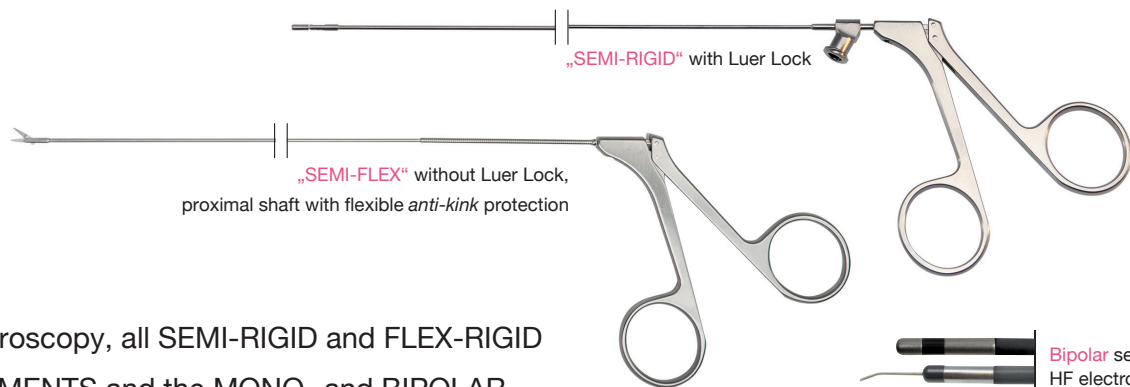

In Hysteroscopy, all SEMI-RIGID and FLEX-RIGID INSTRUMENTS and the MONO- and BIPOLAR ELECTRODES can be equally used with the GUBBINI Original, Ellipse and Midi system.

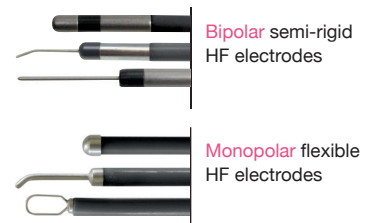

PREPARATION LOOPS (“Cold Loops”) used to prepare submucosal myoma for removal, are currently available for use with the GUBBINI original and ellipse systems.



HF ELECTRODES FOR RESECTOSCOPY

A variety of HF electrodes has been developed to provide optimal tools for resectoscopic procedures; they are available as reusable mono- & bipolar electrodes, and bipolar single-use electrodes. For GUBBINI Original and Ellipse, the HF electrodes are mainly the same; for a better overview, the electrodes for the different instrument systems are shown separately in the respective chapter of each of the systems, plus an overview on page 33.

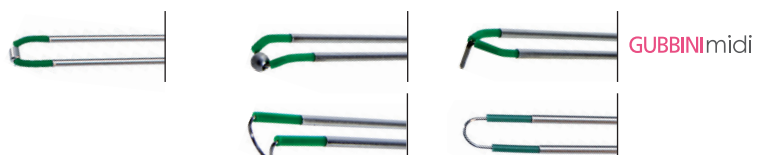



COMPONENTS FOR ALL THREE SYSTEMS

- ▶ Continuous flow sheaths with different shapes

The original GUBBINI System features a round distal tip/sheath form, the introduction into the cervical canal does not require speculum, tenaculum nor Hegar’s dilators. Recently, sheaths with distal tip in teardrop-form were added to the GUBBINI System-Line: the GUBBINI Ellipse instruments facilitate the introduction also in stenotic patients.

GUBBINIoriginal



Round tip with small diameter: 16 Fr.

GUBBINIellipse



Elliptic formed tip for an easier introduction into the cervical canal.
Average diameter: 14.9 Fr.

GUBBINImidi















Oblique formed tip, 18.5 Fr.;
(Dilatation and anesthesia required).

A KEY COMPONENT FOR ALL OF THE GUBBINI SYSTEMS: THE OUTER SHEATH

The one-time placement of the outer sheath, which remains inside the cervical canal during the change from hysteroscopic to resectoscopic procedures (and viceversa) optimally supports the „See & Treat“ approach of modern gynecology. This procedural method clearly shortens the operating time and reduces the strain on patients. The *Quick Lock* connections of all components enable an easy assembly and a smooth exchange of inner sheaths and working channel during the operation.

GUBBINI CONTINUOUS FLOW OUTER SHEATHS

OUTER SHEATH to combine with non-rotatable and rotatable inner sheath and working sheath

Description	Art. No.	Information
GUBBINI OUTER SHEATH; 16 Fr.  	582-150-24GU	 194 mm 
GUBBINI ELLIPSE OUTER SHEATH; 14.9 Fr.  	582-150-24GUE	   
OUTER SHEATH; 18.5 Fr.  	582-180-24	

The complete order information for the continuous flow sheaths, consisting of outer and inner sheath, is shown in the respective chapter of each instrument system.



GUBBINI

► Schematic overview

RESECTOSCOPY

GUBBINIoriginal
GUBBINIellipse

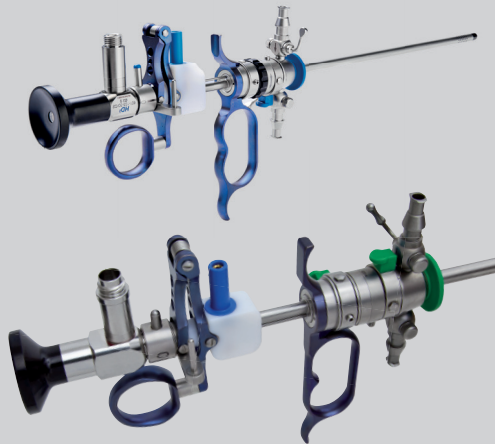

GUBBINImidi

Outer sheath

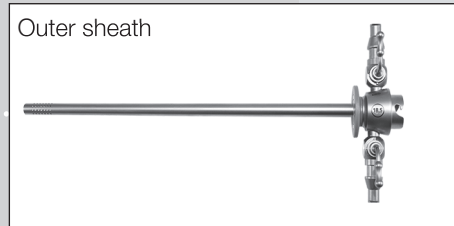

Obturator



(not available for GUBBINI ellipse)

Inner sheath; non-rotatable



Inner sheath; rotatable



(not available for GUBBINI ellipse)

Working sheath



HYSTEROSCOPY

GUBBINIoriginal



GUBBINIellipse



GUBBINImidi

GUBBINI

► Schematic overview

GUBBINI original
GUBBINI ellipse
GUBBINI midi

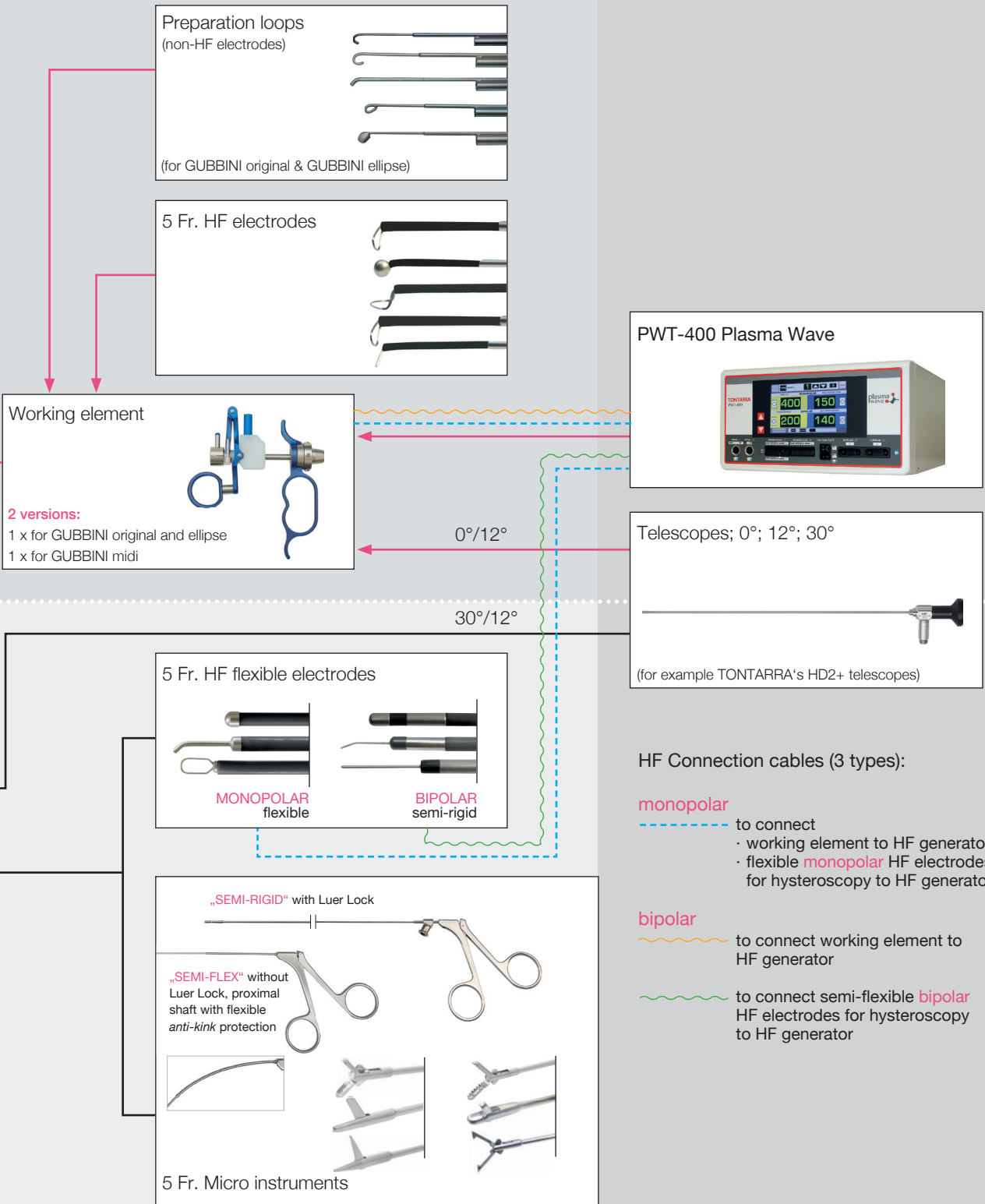

RESECTOSCOPY

HYSTEROSCOPY



ON THE GENTLE SIDE
OF GYNECOLOGY



GUBBINI

GUBBINIoriginal

◀ 16 Fr.

HYSTEROSCOPY

RESECTOSCOPY



GUBBINI MINI HYSTERO-RESECTOSCOPY SYSTEM “original”

GUBBINI CONTINUOUS FLOW SHEATH; all-around perforation

- ▶ Rotatable/Non-rotatable

Distal lateral discharge perforations which, in combination with the inner sheath, provide an excellent continuous irrigation flow

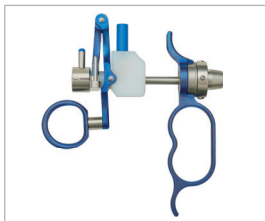
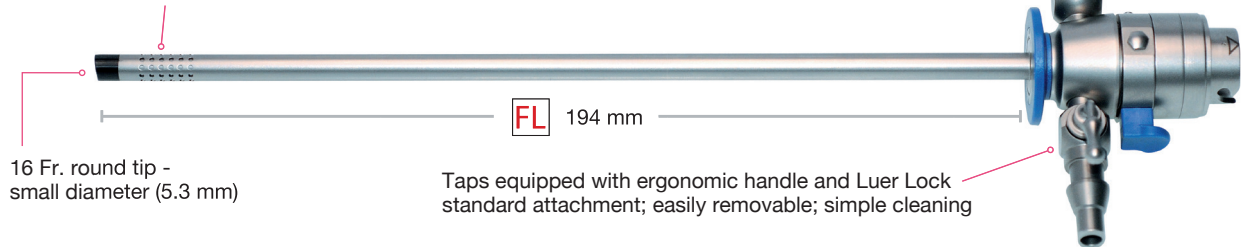

Hybrid working element
Art.No. 582-150-00GUB

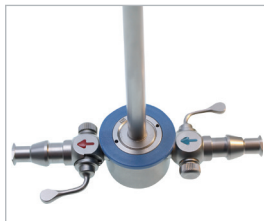

Colored inflow/outflow sign

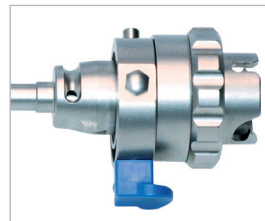

GUBBINI complete continuous flow sheath;
rotatable

GUBBINI WORKING SHEATH

- ▶ Transforms the mini-resectoscope into a highly versatile hysteroscope
- ▶ Change without removal of the outer sheath
- ▶ Easy assembly thanks to *QLS Quick Lock System*



The particular structure of the working channel allows to introduce micro instruments until the distal section of the tool, thus carrying out procedures safely and with a perfect field of view. We recommend to use a 2.9 mm Telescope 12° or 30°.

Distal collar that allows for greater effectiveness in the irrigation process

Connection system of the optical systems fitted with cones and safety lever closing that allows quick assembly and disassembly, ensuring the complete seal of the working element

Reclosable channel for 5 Fr. micro instruments and electrodes



GUBBINI MINI HYSTERO-RESECTOSCOPY SYSTEM “original”









GUBBINI CONTINUOUS FLOW SHEATHS; non-rotatable and rotatable ▶ 16 Fr.

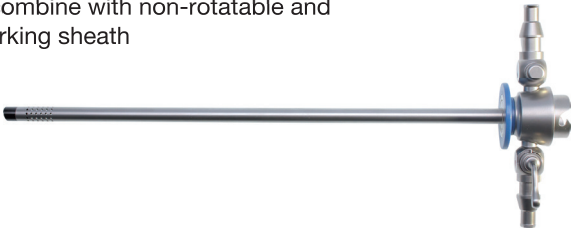

For resectoscopic procedures – designed for use with non-HF preparation loops („Cold Loops“) and HF electrodes

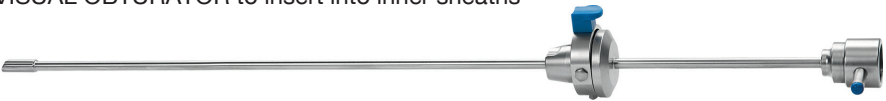
- ▶ Quick Lock connections
- ▶ All-around perforation
- ▶ Telescope 0° recommended for resectoscopy

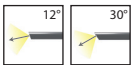

Description	Art. No.	Information
GUBBINI OUTER SHEATH to combine with non-rotatable and rotatable inner sheaths and working sheath 	582-150-24GU	
GUBBINI CONTINUOUS FLOW SHEATH; non-rotatable inner sheath 	582-150-21GU	
GUBBINI CONTINUOUS FLOW SHEATH; rotatable inner sheath 	582-150-26GU	
VISUAL OBTURATOR to insert into inner sheaths 	582-150-30GU	
WORKING ELEMENT; further information see page 8	582-150-00GUB	

GUBBINI WORKING SHEATH SYSTEM ▶ Telescope 12° and 30° recommended for hysteroscopy 

Description	Art. No.	Information
WORKING SHEATH with instrument channel 5 Fr. and channel for Ø 2.9 mm telescope. Designed for use with electrodes and 5 Fr. semi-rigid instruments 	582-150-39GU	
SEALING CAP for instrument channel; 10 pcs./box	499-199-00	
SEALING CAP for instrument channel with special water stop valve; 10 pcs./box	499-198-00	

GUBBINI MINI-RESECTOSCOPY SYSTEM “original”



- ▶ Reusable electrodes for use with bipolar current and conductive solution (NaCl 0.9%)
- ▶ SALINAE disposable electrodes for use with bipolar current and conductive solution (NaCl 0.9%)
- ▶ Reusable electrodes for use with monopolar current and non-conductive solution (Sorbitol, Mannitol, Glycine)



HF-ELECTRODES ▶ for use with working element Art. No. 582-150-00GUB

▶ telescopes 0°

▶ SALINÆ disposable electrodes: sterile; single packaged; 5 pc./unit

⇒ 16 Fr.

Description	Art. No.		
	BIPOLAR	MONOPOLAR	
HF-LOOP ELECTRODE SIZE 1 SMALL ▶ for 0° telescope	—	582-150-40GU	
SALINÆ disposable electrode	582-150-40GUB-S	—	
HF-LOOP ELECTRODE SIZE 2 LARGE ▶ 90° for 0° telescope	—	582-150-41GU	
SALINÆ disposable electrode	582-150-41GUB-S	—	
HF-BALL ELECTRODE ▶ for 0°/12° telescopes	—	582-150-42GU	
SALINÆ disposable electrode	582-150-42GUB-S	—	
HF-KNIFE ELECTRODE ▶ 90° for 0°/12° telescopes	—	582-150-43GU	
SALINÆ disposable electrode	582-150-43GUB-S	—	
HF-LOOP ELECTRODE STRAIGHT ▶ for 0° telescope	—	582-150-44GU	
SALINÆ disposable electrode	582-150-44GUB-S	—	

The GUBBINI System is “fully hybrid” and can be used in mono- or bipolar mode. The trend clearly goes towards the use of saline-solution as distension medium for resectoscopic procedures thanks to its several advantages:

- less risk for hyponatremia and hypervolemia
- less distension volume/less strain on the tissue
- lower work temperature on tissue during surgery which results in less necrosis around the treated areas
- reduction of peripheral nerve stimulation, especially of the N.obturatorius.

HF CONNECTION CABLES; BIPOLAR
▶ to connect working element to HF generator;
bipolar mode for resectoscopy

HF CONNECTION CABLES; MONOPOLAR
▶ to connect working element to HF generator;
monopolar mode for resectoscopy

Available for following units:			Available for following units:	3.0 m
Erbe mod. ICC/ACC, Storz	287-200-30BR	(3.0 m)	Erbe/ICC/ACC/Storz Ø 5.0 mm	582-531-02
Berchthold/ Martin mod. Maxium	287-205-30BR	(3.0 m)	Valleylab/Conmed Ø 8.0 mm	582-532-03
TONTARRA mod. PWZ-400; International Models; 2-pins	287-215-30BR	(3.0 m)	Equipment with banana plug Ø 4.0 mm	582-533-04
Erbe mod. VIO 300D and VIO3 with multi-contact connector; Karl Storz mod./Autocon II 400	287-220-30BR	(4.0 m)		
Emed-HF mod. Spectrum	287-225-30BR	(4.5 m)		
Bowa mod. ; ARC 350 & 400	287-230-30BR	(4.5 m)		

For further information and pictures see the overview of cables at the end of the catalogue.



ON THE GENTLE SIDE
OF GYNECOLOGY



GUBBINI

GUBBINIellipse

◀ 14.9 Fr.

HYSTEROSCOPY
RESECTOSCOPY



EVALUATION “ELLIPSE” MINI-HYSTERO-RESECTOSCOPE SYSTEM

► By Dr. Giampietro Gubbini

The GUBBINI ELLIPSE SYSTEM extends the range of therapeutic options of modern hystero-resectoscopy and further diminishes the discomfort in patients.



- The “ELLIPSE” system marks the completion of the ambitious project “Mini-Hybrid Hystero-Resectoscope for mono- and bipolar use”, which was initiated several years ago with the aim to provide a less traumatic yet effective option for a wide range of hystero-resectoscopic interventions.

With the reduction of the diameter of commonly used 26 Fr. instruments to only 16 Fr. with a working channel of 5 Fr. (and a further reduction to 14.9 Fr. of the outer diameter in case of the ELLIPSE), the first high-performance mini-resectoscopes for all endo-uterine standard procedures have become available.

- By the one-time placement of the outer sheath, which remains inside the cervical canal during the hysteroscopic (rather diagnostic) procedure and the resectoscopic (surgical) intervention, the already well-established “See & Treat” approach has been largely optimized.
- The elliptic profile makes the instrument more ergonomic and compliant towards the orifice of the uterine and cervical canal. The design of the ceramic coated distal section of the outer ELLIPSE sheath enables the use of 2.9 mm optics with 0° and 12° for hysteroscopic procedures, and allows to expand the “See and Treat” procedure of the mini-resectoscope by enabling the use of 0° and 12° telescopes.
- Hysteroscopic procedures on an outpatient basis with vaginoscopic approach and the treatment of pathologies, in which the mini-resectoscope with the round profil might encounter difficulties in its path due to extremely stenotic conditions – such as cervical or endometrial polyps or uterus septus – can now be performed with the clearly less atraumatic ELLIPSE mini-resectoscope, and could replace common hysteroscopes widely used in outpatient 5 mm surgery.



The GUBBINI ELLIPSE model features the same high versatility than the other GUBBINI instruments with resectoscopic loops and tools for 5 Fr. working channels.

The loops available for this system correspond to the ones used with the original mini-resectoscope:

- HF-Loop electrode 1 size: small
- HF-Ball electrode
- HF-Knife electrode 90° angled





GUBBINI MINI-HYSTERO-RESECTOSCOPY SYSTEM “ellipse”

- ▶ Continuous flow sheath

GUBBINI ellipse CONTINUOUS FLOW SHEATH; lateral perforation

- ▶ Non-rotatable

The GUBBINI ELLIPSE SYSTEM is characterized by the elliptic form of sheaths and working channel, with an average external diameter of the outer sheath of only 14.9 French.

The range of 5 Fr. micro instruments, some of them specifically designed for the GUBBINI ELLIPSE System, covers a wide field of applications: HF- and preparation electrodes for resectoscopic procedures, as well as flexible electrodes and semi-rigid hysteroscopic instruments, are indispensable tools in contemporary office hysteroscopy.

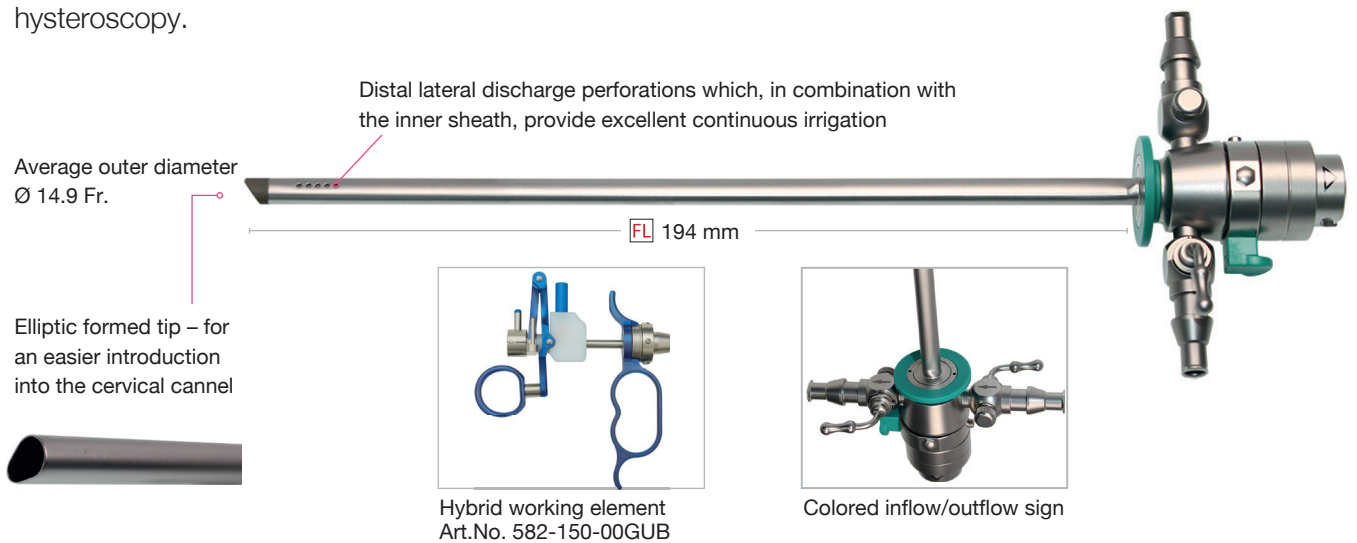

GUBBINI ellipse WORKING SHEATH

- ▶ Transforms the mini-resectoscope into a highly versatile hysteroscope
- ▶ Change without removal of the outer sheath
- ▶ Easy assembly thanks to *QLS Quick Lock System*



The particular structure of the working channel allows to introduce micro instruments until the distal section of the tool, thus carrying out procedures safely and with a perfect field of view. We recommend to use a 2.9 mm telescope 12° or 30°.

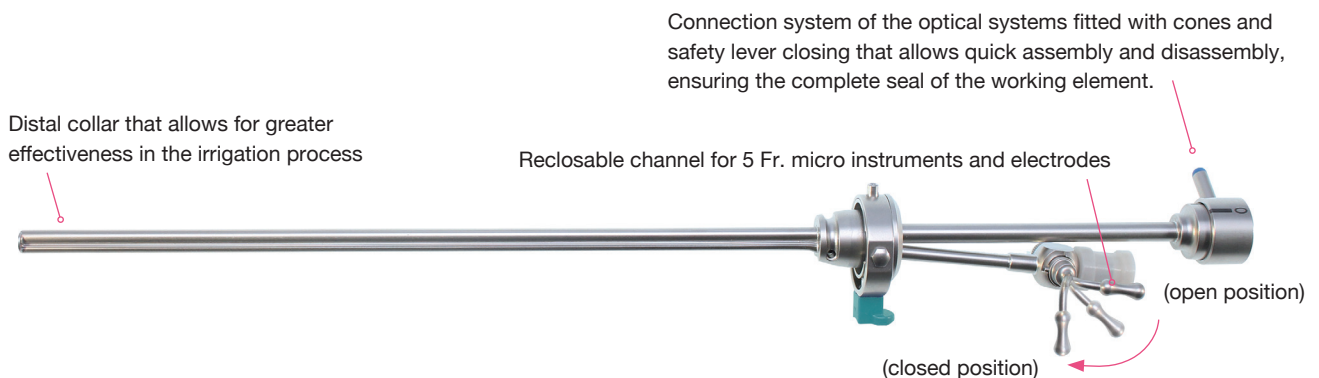

GUBBINI MINI-HYSTERO-RESECTOSCOPY SYSTEM “ellipse”





GUBBINI ELLIPSE CONTINUOUS FLOW SHEATH ▶ 14.9 Fr.

For resectoscopic procedures - designed for use with non-HF preparation loops and HF-electrodes



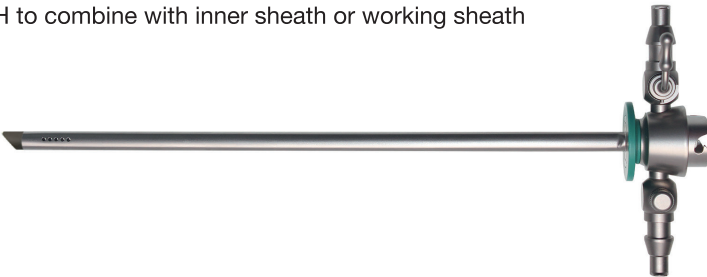

- Quick Lock connections
- All-around perforation
- Telescope 0° and 12° recommended for resectoscopy



Description	Art. No.	Information
GUBBINI ELLIPSE OUTER SHEATH OUTER SHEATH to combine with inner sheath or working sheath	582-150-24GUE	
		
GUBBINI ELLIPSE CONTINUOUS FLOW SHEATH INNER SHEATH non-rotatable	582-150-21GUE	
		
WORKING ELEMENT; further information see page 8	582-150-00GUB	

GUBBINI ELLIPSE WORKING SHEATH

- ▶ Telescope 12° and 30° recommended for hysteroscopy 

Description	Art. No.	Information
WORKING SHEATH with instrument channel 5 Fr. and channel for Ø 2.9 mm telescope. Designed for use with electrodes and 5 Fr. semi-rigid instruments.	582-150-39GUE	 
		
SEALING CAP for instrument channel; 10 pcs./box	499-199-00	
SEALING CAP for instrument channel with special water stop valve; 10 pcs./box	499-198-00	

- ▶ The ELLIPSE WORKING SHEATH: transforms the mini-resectoscope into a highly versatile hysteroscope
- ▶ Adapted to the elliptic form of the outer sheath
- ▶ Change without removal of the outer sheath
- ▶ Easy assembly thanks to *QLS Quick Lock System*



GUBBINI MINI-RESECTOSCOPY SYSTEM “ellipse”

- ▶ Reusable electrodes for use with bipolar current and conductive solution (NaCl 0.9%)
- ▶ SALINÆ disposable electrodes for use with bipolar current and conductive solution (NaCl 0.9%)
- ▶ Reusable electrodes for use with monopolar current and no-conductive solution (Sorbitol, Mannitol, Glycine)



HF-ELECTRODES ▶ for use with working element; Art. No. 582-150-00GUB

▶ recommended telescopes 0°/12°

▶ SALINÆ disposable electrodes: sterile; single packaged; 5 pc./unit

➡ 14.9 Fr.

Description	Art. No.		
	BIPOLAR	MONOPOLAR	
HF-LOOP ELECTRODE SIZE 1 SMALL ▶ for 12° telescope	—	582-150-40GU	
SALINÆ disposable electrode	582-150-40GUBE-S	—	
HF-BALL ELECTRODE; ▶ for 0°/12° telescope	—	582-150-42GU	
SALINÆ disposable electrode	582-150-42GUB-S	—	
HF-KNIFE ELECTRODE ▶ 90° for 0°/12° telescope	—	582-150-43GU	
SALINÆ disposable electrode	582-150-43GUB-S	—	

The GUBBINI System is “fully hybrid” and can be used in mono- or bipolar mode. The trend clearly goes towards the use of saline-solution as distension medium for resectoscopic procedures thanks to its several advantages:

- less risk for hyponatremia and hypervolemia
- less distension volume/less strain on the tissue
- lower work temperature on tissue during surgery which results in less necrosis around the treated areas
- reduction of peripheral nerve stimulation, especially of the N.obturatorius.

HF CONNECTION CABLES; BIPOLAR
▶ to connect working element to HF generator;
bipolar mode for resectoscopy

HF CONNECTION CABLES; MONOPOLAR
▶ to connect working element to HF generator;
monopolar mode for resectoscopy

Available for following units:			Available for following units:	3.0 m
Erbe mod. ICC/ACC, Storz	287-200-30BR	(3.0 m)	Erbe/ICC/ACC/Storz Ø 5.0 mm	582-531-02
Berchthold/ Martin mod. Maxium	287-205-30BR	(3.0 m)	Valleylab/Conmed Ø 8.0 mm	582-532-03
TONTARRA mod. PWT-400; International Models; 2-pins	287-215-30BR	(3.0 m)	Equipment with banana plug Ø 4.0 mm	582-533-04
Erbe mod. VIO 300D and VIO3 with multi-contact connector; Karl Storz mod./Autocon II 400	287-220-30BR	(4.0 m)		
Emed-HF mod. Spectrum	287-225-30BR	(4.5 m)		
Bowa mod.; ARC 350 & 400	287-230-30BR	(4.5 m)		

For further information and pictures see the overview of cables at the end of the catalogue.



ON THE GENTLE SIDE
OF GYNECOLOGY



GUBBINI

GUBBINImidi

◀ 18.5 Fr.

HYSTEROSCOPY
RESECTOSCOPY



GUBBINI HYSTERO-RESECTOSCOPY SYSTEM „midi“

▶ 18.5 Fr.

The **GUBBINI midi** hybrid hystero-resectoscope 18.5 French is based upon the same innovative technical principles than its smaller siblings GUBBINI (16 Fr.) and GUBBINI Ellipse (14.9 Fr.), and is suitable for use with:

- ▶ **bipolar current** and conductive saline solution (NaCl 0.9%)
- ▶ **monopolar current** and no-conductive solution (Sorbitol, Mannitol, Glycine).



Even though the size requires the dilation of the cervix and with that, anesthesia, the small diameter and the time-saving one-time placement of the outer sheath clearly reduces unnecessary tissue damages and the strain on patients.

The **GUBBINI midi** features the excellent functionality and handiness of all GUBBINI systems, while the size of the loops facilitates the treatment of larger myoma, or more extended intracavitary lesions.

- One-time placement of outer sheath
- Rotatable and non-rotatable inner sheaths available
- To be used with Ø 2.9 mm, 0°, 12°, 30° telescopes
- Variety of specially designed HF electrodes, preparation electrodes and semi-rigid instruments available
- *Quick Lock* connecting system: Easy assembly and disassembly, allows a smooth change of sheaths during an intervention with tight sealing of the two connected sheaths
- Working element with structural sections and hinges of light-weighted Titanium
- Perfectly optimized continuous flow rate for a clear view
- Fully hybrid – the GUBBINI midi is suitable for bipolar modus in physiologic distension medium (Saline solution only: NaCl 0.9%), or monopolar use.

GUBBINI midi continuous flow sheath; **rotatable**



Working sheath

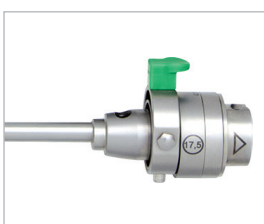

GUBBINI midi inner sheath; **non-rotatable**

GUBBINI midi Tip with loop electrode; 30° angled









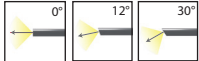

GUBBINI HYSTERO-RESECTOSCOPY SYSTEM “midi”

► Sheath overview

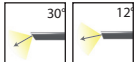
GUBBINI MIDI SYSTEM

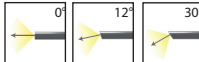

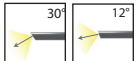
Rotatable	Colour code	Art. No.	Information
OUTER SHEATH ► 18.5 Fr. 	■ green	582-180-24	
INNER SHEATH ► 17.5 Fr. 	■ green	582-180-26	
WORKING SHEATH with instrument channel 5 Fr. ► for 18.5 Fr. 	■ green	582-180-39	
Not-rotatable			
OUTER SHEATH ► 18.5 Fr. 	■ ■ green/blue	582-180-22	
INNER SHEATH ► 17.5 Fr. 	■ green	582-180-21	
WORKING SHEATH with instrument channel 5 Fr. for use with 582-180-22 ► for 18.5 Fr. 	■ ■ green/blue	582-180-38	

GUBBINI RESECTOSCOPY SYSTEM “midi”



- ▶ Reusable electrodes for use with bipolar current and conductive solution (NaCl 0.9%)
- ▶ SALINÆ disposable electrodes for use with bipolar current and conductive solution (NaCl 0.9%)
- ▶ Reusable electrodes for use with monopolar current and no-conductive solution (Sorbitol, Mannitol, Glycine)

- HF ELECTRODES**
- ▶ for use with working element; Art. No. 582-180-00B
 - ▶ recommended telescopes 12° and 30°
 - ▶ SALINÆ disposable electrodes: single packaged; 5 pc./unit

18.5 Fr.

Description	Colour code	Art. No.	Art. No.	
		BIPOLAR	SALINÆ disposable	
HF loop electrode; 30° angled	■ green	582-180-40B	582-180-40B-S	
HF loop electrode; straight	■ green	582-180-41B	582-180-41B-S	
HF knife electrode	■ green	582-180-42B	582-180-42B-S	
HF ball electrode; Ø 2 mm	■ green	582-180-43B	582-180-43B-S	
HF roller electrode; Ø 2 mm	■ green	582-180-44B	—	

For HF connection cables see overview in ACCESSORIES

GUBBINI midi WORKING ELEMENT

Description	MIDI	
For passive cutting / closed handle / with titanium hinge graduated / Quick Lock system / suitable for Ø 2.9 mm 0°; 12° and 30° telescopes	582-180-00B	
Safety distance holder (1.1 mm width) for bipolar working element 582-180-00B; 1 pc.	582-150-02GUB	

The GUBBINI System is “fully hybrid” and can be used in mono- or bipolar mode. The trend clearly goes towards the use of saline-solution as distension medium for resectoscopic procedures thanks to its several advantages; the latest model GUBBINI „midi“ only features bipolar electrodes for resectoscopy.

- less risk for hyponatremia and hypervolemia
- less distension volume/less strain on the tissue
- lower work temperature on tissue during surgery which results in less necrosis around the treated areas
- reduction of peripheral nerve stimulation, especially of the N.obturatorius.

HF CONNECTION CABLES; BIPOLAR
 ▶ to connect working element to HF generator;
 bipolar mode for resectoscopy

HF CONNECTION CABLES; MONOPOLAR
 ▶ to connect working element to HF generator;
 monopolar mode for resectoscopy

Available for following units:			Available for following units:	3.0 m
Erbe mod. ICC/ACC, Storz	287-200-30BR	(3.0 m)	Erbe/ICC/ACC/Storz Ø 5.0 mm	582-531-02
Berchthold/ Martin mod. Maxium	287-205-30BR	(3.0 m)	Valleylab/Conmed Ø 8.0 mm	582-532-03
Tontarra mod. PWT-400; International Models; 2-pins	287-215-30BR	(3.0 m)	Equipment with banana plug Ø 4.0 mm	582-533-04
Erbe mod. VIO 300D and VIO3 with multi-contact connector; Karl Storz mod./Autocon II 400	287-220-30BR	(4.0 m)		
Emed-HF mod. Spectrum	287-225-30BR	(4.5 m)		
Bowa mod.; ARC 350 & 400	287-230-30BR	(4.5 m)		

ON THE GENTLE SIDE
OF GYNECOLOGY



GUBBINI

MICRO-INSTRUMENTS

GUBBINIoriginal

GUBBINIe||ipse

GUBBINImidi



MICRO INSTRUMENTS FOR HYSTEROSCOPY

- ▶ Semi-rigid & semi-flexible instruments for instrument channel 5 Fr. for all three systems
- ▶ Available with Luer Lock, or proximal shaft with flexible *anti-kink* protection and *without* Luer Lock

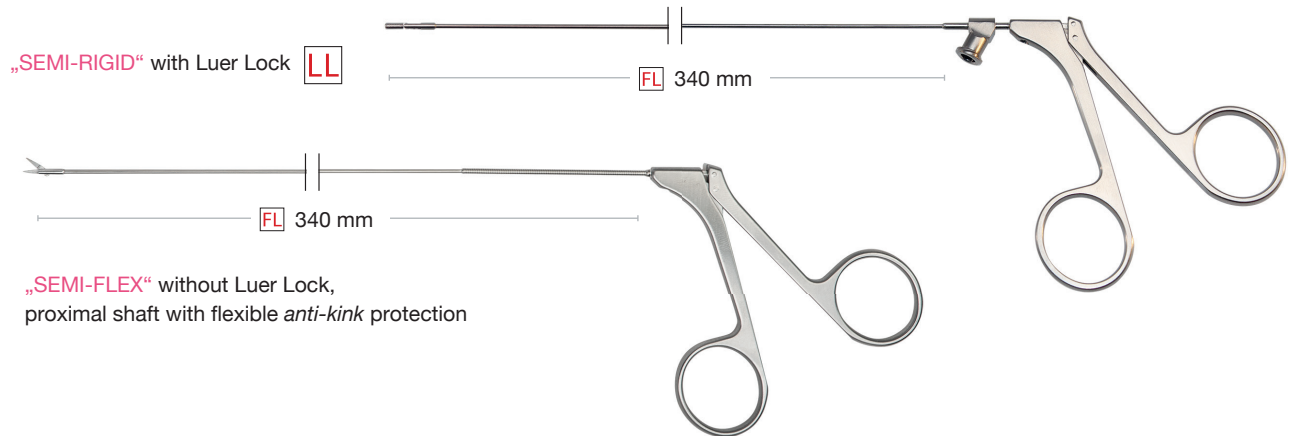

SEMI-RIGID INSTRUMENTS Ø 1.6 mm ▶ with LUER LOCK or ANTI-KINK protection

Description	Semi-Rigid (LuerLock)	Semi-Flex (Anti-Kink protection)	
BIOPSY FORCEPS ▶ oval ▶ double action	583-214-16LL	—	
SCISSORS ▶ blunt ▶ single action	583-228-16LL	583-228-16FS	
SCISSORS ▶ pointed ▶ single action	583-229-16LL	583-229-16FS	
BIOPSY AND GRASPING FORCEPS ▶ oval ▶ double action	583-256-16LL	583-256-16FS	
PUNCH ▶ through-cutting ▶ single action	583-258-16LL	—	
TENACULUM FORCEPS ▶ oval ▶ double action	583-278-16LL	—	
BIOPSY FORCEPS ▶ oval, Ø 1.2 mm ▶ double action, with pin	583-250-16G	—	
BIOPSY FORCEPS ▶ oval, Ø 1.2 mm, FL 400 mm ▶ double action, with pin	583-250-40G	—	
MYOMA FIXATION instrument	583-280-00	—	

GUBBINI SYSTEM: HF ELECTRODES FOR HYSTEROSCOPY



GUBBINI original
GUBBINI ellipse
GUBBINI midi



▶ Mono- and bipolar HF electrodes for all three systems



HF ELECTRODES; MONOPOLAR; flexible ▶ FL 470 mm

			
Size	Button electrode	Needle electrode; angled	Loop electrode
5 Fr.	582-510-05	582-511-05	582-514-05

HF CONNECTION CABLES; MONOPOLAR ▶ to connect flexible monopolar HF electrodes for hysteroscopy to HF generator

Available for following units: Erbe/ICC/ACC/Storz Ø 5 mm Valleylab; Conmed Ø 8 mm Equipment with banana plug Ø 4 mm	3.0 m 582-531-02 582-532-03 582-533-04		For further information and pictures see the overview of cables at the end of the catalogue.
---	--	--	--



HF ELECTRODES; BIPOLAR; semi-rigid ▶ FL 360 mm Size 5 Fr.

			
Button electrode	Needle electrode; angled 45°	Needle electrode; angled 90°	Needle electrode; straight
582-515-05	582-516-05	582-518-05	582-517-05

HF CONNECTION CABLES; BIPOLAR ▶ to connect flexible bipolar HF electrodes for hysteroscopy to HF generator

Available for following units: Erbe ICC/ACC; Storz/unit side round plug Berchthold/Martin/unit side round plug US-Models; 2-pins/unit side banana plugs Valleylab; International Models; 2 pins	3.0 m 287-200-30 287-205-30 287-210-30 287-215-30	5.0 m 287-200-50 287-205-50 287-210-50 287-215-50		For further information and pictures see the overview of cables at the end of the catalogue.
--	--	--	--	--

GUBBINI SYSTEM: RESECTOSCOPY

- ▶ Preparation Loops ("Cold Loops") for GUBBINI original and GUBBINI ellipse SYSTEM

GUBBINI original
GUBBINI ellipse



"Cold Loops": Efficient & safe myomectomy of submucosal myoma
Designed specifically for treating submucosal G1 and G2 Myomas



"Cold Loops", so-called because they are used without HF current, only employ mechanical energy for enucleation.

PREPARATION LOOPS („Cold Loops“)

- ▶ for use with working element Art. No. 582-150-00GUB and round continuous flow sheath 16 Fr.

Description	Art. No.	
J-HOOK PREPARATION LOOP; small; non-HF	582-150-45GU	
J-HOOK PREPARATION LOOP; medium; non-HF	582-150-46GU	
CIRCULAR PREPARATION LOOP; non-HF	582-150-47GU	
LANCET PREPARATION LOOP 60°; non-HF	582-150-48GU	
SPATULA PREPARATION LOOP; non-HF	582-150-49GU	

- ▶ For currentless use only
- ▶ CAUTION: The preparation loops may never be used when the current is on. Make absolutely sure that the resectoscope is not connected to any HF-unit when you are using the preparation loops.

Advantages of "Cold Loops" and the mechanical enucleation technique:

- ▶ Less traumatizing intervention: less weakening of the myometrium
- ▶ Avoiding of thermal damage to blood vessels: the vascularized connective tissue bridges are lacerated without the use of any type of HF current
- ▶ No forming of fibrotic scarring during the healing process

THE METHOD IN SHORT:

Following the elimination of the intracavitary component using the traditional resectoscopic „slicing“ technique with a monopolar or bipolar current, the intramural component gets removed by using „Cold Loops“ by exercising force in the cleavage space between the myoma and the surrounding myometrium to separate the myoma from the uterine wall. Thus, the intramural component of the myoma is transformed into an intracavitary component, which can then be removed using the traditional technique.

GUBBINI SYSTEM: RESECTOSCOPY

▶ HF electrodes for all 3 systems – overview

GUBBINI original
GUBBINI ellipse
GUBBINI midi



SALINÆ electrodes:
disposable; sterile;
single packaged; 5 pc./unit

HF-ELECTRODES GUBBINI original GUBBINI ellipse

▶ for use with working element Art. No. 582-150-00GUB

¹ GUBBINI Classic System (round sheaths): 0° telescope ² GUBBINI Ellipse System (tear-drop formed sheaths): recommended telescopes 0°; 12°

Description	Art. No.	Art. No.		for Telescopes 2.9 mm		
				BIPOLAR	MONOPOLAR	0°
HF-LOOP ELECTRODE SIZE 1 SMALL	—	582-150-40GU				
SALINÆ disposable electrode	582-150-40GUB-S	—		x ¹	—	—
HF-LOOP ELECTRODE SIZE 1 SMALL	—	582-150-40GU				
SALINÆ disposable electrode	582-150-40GUBE-S	—		x ²	x ²	—
HF-LOOP ELECTRODE SIZE 2 LARGE; 90°	—	582-150-41GU				
SALINÆ disposable electrode	582-150-41GUB-S	—		x ¹	—	—
HF-BALL ELECTRODE	—	582-150-42GU				
SALINÆ disposable electrode	582-150-42GUB-S	—		x ¹⁺²	x ²	—
HF-KNIFE ELECTRODE; 90°	—	582-150-43GU				
SALINÆ disposable electrode	582-150-43GUB-S	—		x ¹⁺²	x ²	—
HF-LOOP ELECTRODE STRAIGHT	—	582-150-44GU				
SALINÆ disposable electrode	582-150-44GUB-S	—		x ¹	—	—

HF ELECTRODES GUBBINI midi

▶ for use with working element Art. No. 582-180-00B, for bipolar use only

Description	Art. No		for Telescopes 2.9 mm		
			BIPOLAR	0°	12°
HF-LOOP ELECTRODE; 30° angled	582-180-40B				
SALINÆ disposable electrode	582-180-40B-S		(x)	x	x
HF LOOP ELECTRODE; straight	582-180-41B				
SALINÆ disposable electrode	582-180-41B-S		x	(x)	(x)
HF KNIFE ELECTRODE	582-180-42B				
SALINÆ disposable electrode	582-180-42B-S		(x)	x	x
HF BALL ELECTRODE; Ø 2 mm	582-180-43B				
SALINÆ disposable electrode	582-180-43B-S		(x)	x	x
HF ROLLER ELECTRODE; Ø 2 mm	582-180-44B		(x)	x	x



GUBBINI HYSTEROSCOPY & RESECTOSCOPY SYSTEM

- ▶ **G** recommended by Dr. GUBBINI
- ▶ **C** compatible
- ▶ **-** not compatible

RESECTOSCOPY

GUBBINI Models	TELESCOPE Ø 2.9 mm			GUBBINI COMPONENTS			
	0°	12°	30°	Outer Sheath	Inner Sheath	Visual Obturator	Working element hybrid
	601-103-00HD2	601-103-12HD	601-103-30HD2				
GUBBINI original resectoscope 16 Fr. rotatable	G	-	-	582-150-24GU	582-150-26GU	582-150-30GU	582-150-00GUB
GUBBINI original resectoscope 16 Fr. non-rotatable	G	-	-		582-150-21GU		
GUBBINI ellipse resectoscope 14.9 Fr. non-rotatable	G	C	-	582-150-24GUE	582-150-21GUE	-	
GUBBINI midi resectoscope 18.5 Fr. rotatable	C	G	G	582-180-24	582-150-26	582-180-23	582-180-00GUB
GUBBINI midi resectoscope 18.5 Fr. non-rotatable	C	G	G	582-180-22	582-150-21		

HYSTEROSCOPY

HF UNIT GENERATOR

GUBBINI Models	TELESCOPE Ø 2.9 mm			GUBBINI COMPONENTS			
	0°	12°	30°	Outer Sheath	Working Sheath	Visual Obturator	Working element hybrid
	601-103-00HD2	601-103-12HD	601-103-30HD2				
GUBBINI original hysteroscope	C	G	G	582-150-24GU	582-150-39GU	-	-
GUBBINI ellipse hysteroscope	C	G	G	582-150-24GUE	582-150-39GUE	-	-
GUBBINI midi hysteroscope (with rotatable outer sheath)*	C	G	G	582-180-22	582-180-39	-	-
GUBBINI midi hysteroscope (with non-rotatable outer sheath)	C	G	G	582-180-22	582-180-38		

*During hysteroscopic procedures, the outer rotatable sheath is not turnable; for technical reasons it requires another working sheath than the non-turnable outer sheath. The functionality of both MIDI hysteroscopes is identical.



GUBBINI HYSTEROSCOPY & RESECTOSCOPY SYSTEM

- ▶ **G** recommended by Dr. GUBBINI
- ▶ **C** compatible
- ▶ **-** not compatible

RESECTOSCOPY

GUBBINI MICRO INSTRUMENTATION & LOOPS FOR RESECTOSCOPY				RESECTOSCOPY												
HF RESECTOSCOPY ELECTRODES			„COLD LOOPS“ (non-HF Loops)			GUBBINI Models										
	bipolar	monopolar														
HF-LOOP ELECTRODE SIZE 1 SMALL	—	582-150-40GU	J-hook preparation loop; small; 582-150-45GU	J-hook preparation loop; medium; 582-150-46GU	Circular preparation loop; 582-150-47GU	Lancet preparation loop 45°; 582-150-48GU	Spatula preparation loop; 582-150-49GU	GUBBINI original resectoscope 16 Fr. <i>rotatable</i>								
SALINÆ disposable electrode	582-150-40GUB-S	—														
HF-LOOP ELECTRODE SIZE 1 SMALL	—	582-150-40GU														
SALINÆ disposable electrode	582-150-40GUBE-S	—														
HF-LOOP ELECTRODE SIZE 2 LARGE; 90°	—	582-150-41GU														
SALINÆ disposable electrode	582-150-41GUB-S	—														
HF-BALL ELECTRODE	—	582-150-42GU														
SALINÆ disposable electrode	582-150-42GUB-S	—														
HF-KNIFE ELECTRODE; 90°	—	582-150-43GU														
SALINÆ disposable electrode	582-150-43GUB-S	—														
HF-LOOP ELECTRODE STRAIGHT	—	582-150-44GU	Please inquire for further information about „Cold Loops“ for the Midi-System.					GUBBINI ellipse resectoscope 14.9 Fr. <i>non-rotatable</i>								
SALINÆ disposable electrode	582-150-44GUB-S	—														
HF-LOOP ELECTRODE; 30° angled	582-180-40B	—														
SALINÆ disposable electrode	582-180-40B-S	—														
HF LOOP ELECTRODE; straight	582-180-41B	—														
SALINÆ disposable electrode	582-180-41B-S	—														
HF KNIFE ELECTRODE	582-180-42B	—														
SALINÆ disposable electrode	582-180-42B-S	—														
HF BALL ELECTRODE; Ø 2 mm	582-180-43B	—														
SALINÆ disposable electrode	582-180-43B-S	—														
HF ROLLER ELECTRODE; Ø 2 mm	582-180-44B	—	HYSTEROSCOPY													
SALINÆ disposable electrode	582-180-44GUB-S	—														
PWT-400 PLASMA WAVE	540-280-40															
FLEXIBLE HF-ELECTRODES									SEMI-RIGID/SEMI-FLEX INSTRUMENTS			GUBBINI Models				
bipolar semi-rigid	monopolar flexible								Extension of article-numbers: LL = semi-rigid / FS = semi-flex							
Button electrode 582-515-05	Needle electrode, angled 582-516-05	Needle electrode, straight 582-517-05							Biopsy forceps; oval double action 583-214-16 (LL)	Scissors blunt; single action 583-228-16 (LL/FS)	Scissors pointed 583-229-16 (LL/FS)	Biopsy and grasping forceps; oval single action 583-256-16 (LL/FS)	Punch trough-cutting 583-258-16 (LL)	Tenaculum forceps; oval double action 583-278-16 (LL)	Myoma fixation instrument 583-280-00	GUBBINI original hysteroscope
Needle electrode, angled 582-516-05																GUBBINI ellipse hysteroscope
Needle electrode, straight 582-517-05																GUBBINI midi hysteroscope
Button electrode 582-510-05	Needle electrode, angled 582-511-05	Loop electrode 582-514-05														GUBBINI midi hysteroscope
Needle electrode, angled 582-511-05																



ON THE GENTLE SIDE
OF GYNECOLOGY



GUBBINI

ACCESSORIES

GUBBINIoriginal

GUBBINIe||ipse

GUBBINImidi



ACCESSORIES FOR THE GUBBINI SYSTEMS

► Telescopes & equipment

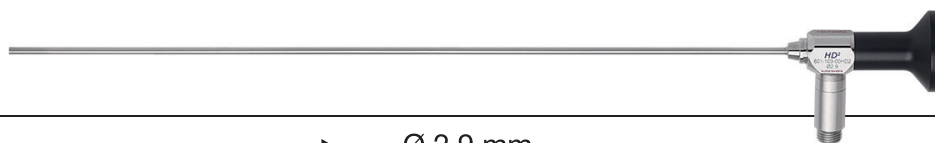

TELESCOPES [autoclavable]

► Ø 2.9 mm

Description	Art. No.	
TELESCOPE HD+2 ► Ø 2.9 mm; 0° FL 300 mm	601-103-00HD2	· Field of view: 80°
TELESCOPE HD+2 ► Ø 2.9 mm; 12° FL 300 mm	601-103-12HD2	· Compatible with most instrument- and camera systems
TELESCOPE HD+2 ► Ø 2.9 mm; 30° FL 300 mm	601-103-30HD2	



FIBER LIGHT GUIDE CABLES Ø 3.5 mm ► Stability & resistance for a long life time
 ► without connectors

Description	Standard Cold Light Line	HTT High Temperature Technology Line
Cold light sources	HALOGEN <i>careful w/Xenon light!</i>	XENON
Sizes	Art. No.'s	
Ø 3.5 x 1800 mm Length	540-803-18	540-813-18
Ø 3.5 x 2300 mm Length	540-803-23	540-813-23
Ø 3.5 x 3000 mm Length	540-803-30	540-813-30
Ø 3.5 x 5000 mm Length	540-803-50	540-813-50
Tube colours The Standard colour is grey.	Only available in grey	● LL (Lilac) ● YW (Yellow) ● GN (Green) Colour Coding made easy: If you want to order one of the shown colours Lilac, Yellow or Green, please indicate the corresponding extensions shown in the column to the right (f.e. for a green cable add „GN“, the article number then reads 540-XXX-XXGN)
Handle Colours	Black	Blue

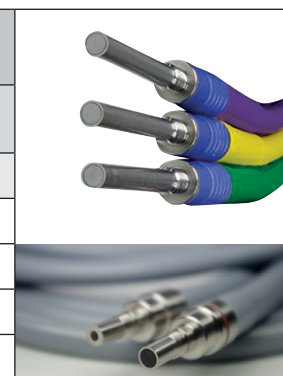

LIGHT CABLE CONNECTORS

Projector-side (light input)			Telescope-side (light output)		
Storz/Aesculap	540-890-02		TONTARRA/Storz/Aesculap/Olympus (old)	540-880-02	
Olympus/ACMI	540-890-10				
Olympus new (switch)	540-890-14		Olympus new	540-880-04	
Wolf	540-890-04		Wolf/HSW/Dyonics snap	540-880-13	
			Wolf/HSW/Dyonics clip	540-880-05	
ACMI/British/Codman	540-890-01		ACMI/British/Codman	540-880-01	















ACCESSORIES FOR THE GUBBINI SYSTEMS

- ▶ HF Unit and HF connection cables





HF UNIT PLASMA WAVE

Description	Art. No.	
PWT-400 Plasma Wave; HF generator for electrical surgery	540-280-50	

HF CONNECTION CABLES; **BIPOLAR** ▶ to connect working element to HF generator; bipolar mode for resectoscopy

Description	Length	Art. No.	Instrument-side	Unit-side
Erbe ICC/ACC, Storz	3.0 m	287-200-30BR		
Berchthold/ Martin mod. Maxium	3.0 m	287-205-30BR		
TONTARRA mod. PWT-400; International Models; 2-pins	3.0 m	287-215-30BR		
Erbe mod. VIO300D; Erbe mod. VIO3 with multi-contact connector; Karl Storz mod. Autocon II 400	4.0 m	287-220-30BR		
Emed-HF mod. Spectrum	4.5 m	287-225-30BR		
Bowa mod.; ARC 350 & 400	4.5 m	287-230-30BR		

HF CONNECTION CABLES; **BIPOLAR** ▶ to connect flexible bipolar HF electrodes for hysteroscopy to HF generator

Available for following units:	3.0 m	5.0 m	Instrument-side	Unit-side
Erbe ICC/ACC, Storz/unit side round plug	287-200-30	287-200-50		
Berchthold/Martin/unit side round plug	287-205-30	287-205-50		
Us-Models; 2-pins/unit side banana plugs	287-210-30	287-210-50		
Valleylab; International Models; 2 pins	287-215-30	287-215-50		







ACCESSORIES FOR THE GUBBINI SYSTEMS

- ▶ Monopolar HF connection cables
- ▶ Storage & sterilization
- ▶ Local anesthesia

HF CONNECTION CABLES; **MONOPOLAR**

- ▶ to connect working element to HF generator; **monopolar** mode for resectoscopy
- ▶ to connect flexible **monopolar** HF electrodes for hysteroscopy to HF generator

Available for following units:	3.0 m	Instrument-side	Unit-side
Erbe/ICC/ACC/Storz; Ø 5.0 mm	582-531-02		
Valleylab, Conmed; Ø 8.0 mm	582-532-03		
Equipment with banana plug; Ø 4.0 mm	582-533-04		

PERFORATED SHEET BASKET FOR GUBBINI SYSTEM; complete with holders for instruments and telescopes

Description:	Art. No.	
<p>PERFORATED SHEET BASKET</p> <ul style="list-style-type: none"> ▶ 480 mm (L) x 245 mm (W) x 80 mm (H) 	582-150-60GU	

HYSTEROBLOCK - UTERINE PARACERVICAL BLOCK NEEDLE 270 mm

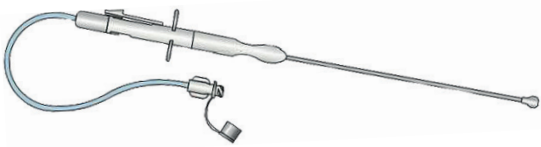
Description:	Art. No.	
<p>HYSTERO-BLOCK NEEDLE; Ø 20G</p> <ul style="list-style-type: none"> ▶ 10 pc./unit ▶ Pain reduction made easy, safe and reliable by placing injections at two points of the right and left lateral vaginal fornix. 	Belo/2-PB02N	

Produced by BEL Bio Engineering Laboratories S.R.L, Ital - distributed by TONTARRA

DR. RAFFAELE RICCIARDI

► An expert in Mini-Resectoscopy



PARACERVICAL LOCAL BLOCKADE IN MINI-RESECTOSCOPY

“Applying injection of local anesthetics before hysteroscopic office procedures leads to significant pain reduction”.

The practical guideline in office hysteroscopy,
by SEGI (Società Italiana di Endoscopia Ginecologica)

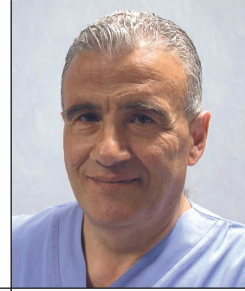

Dr. Raffaele RICCIARDI is one of the most experienced PhDs for the Gubbini System. He introduces doctors from around the world to the multiple therapeutic options of 14.9 Fr. and 16 Fr. Mini-resectoscopy in the operation theatre or in an office setting.

With more than 60,000 diagnostic and operative hysteroscopic procedures Dr. Raffaele Ricciardi is one of the top experts in the field. He also published and co-authored several studies and articles. Dr. Ricciardi annually performs 1300 surgeries, of these over 700 with paracervical local blockades.

The mini-sizes of the GUBBINI original and ellipse instruments allow to perform hysteroscopic and resectoscopic interventions without anesthesia at all. Still, some patients will need at least local anesthesia.

Criteria to apply local anesthesia on the patient’s side are anatomic circumstances (for example patients who never gave birth may experience more pain), or the anticipated anxiety and stress level during an intervention; **applying local anesthesia is reassuring for patient and gynecologist alike.**

Another criteria is of course the intervention itself; its duration is a determining factor for pain sensation.

Another point is the experience of the surgeon: the learning curve is described to take around 30 surgeries until optimal results in regards to patient convenience is reached.

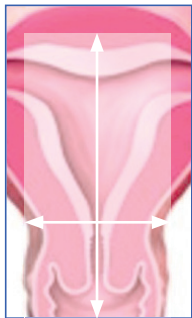

Anesthetized area

In any case: Anesthesia assistance should be within reach in case of an emergency (remember: The Gubbini System can often substitute commonly used larger instruments for interventions under general anesthesia, which usually require hospitalization).

Dr. Raffaele RICCIARDI

born in Andria, Italy, in 1953, graduated *cum laude* in Medicine at the University of Pavia in 1977, and received his Certification as a specialist in Obstetrics and Gynecology in 1982.

In 1983 he started his brilliant career as a gynecologist at the renowned IRCCS (Institute for Research and Health Care) polyclinic “Casa Sollievo della Sofferenza”, San Giovanni Rotondo. Since 1985 he dedicated himself intensively to diagnostic and operative hysteroscopy, participating as instructor, lecturer and speaker in several courses, conferences and congresses around the world.

In 1998 he became a member of the Executive Council at the Diagnostic and Operative Hysteroscopy School “Arbor Vitae”, directed by Prof. Ivano Mazzon (based in Rome).

Since 2007 he is the Director of the Hysteroscopy Department, Abano Terme Polyclinic.

Reference center for Mini-Resectoscopy

MINI RESECTOSCOPY Reference centers

The Gubbini System had first been introduced in Italy, a country with well-known tradition in the development of modern gynecology. There, three clinics alone perform more than 1.500 operations with the Gubbini System per year.

By now, the GUBBINI System has made its way into prestigious clinics in many parts of the world. Please inquire for a list of reference clinics and training options: gubbini@tontarra.de

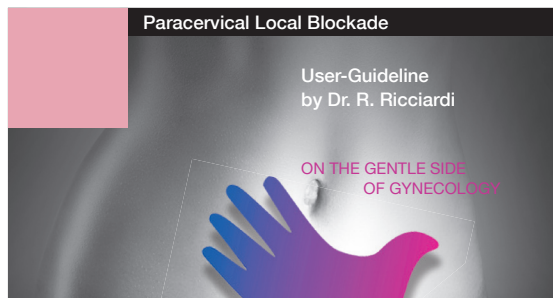

Please contact us for further information and the *User-Guideline* by Dr. Ricciardi:
gubbini@tontarra.de



INDEX

287-200-30	31	540-280-50	39	582-150-40GUB-S	35	582-180-40B	33	582-533-04	28
287-200-30	39	540-803-18	38	582-150-41GU	18	582-180-40B	35	582-533-04	31
287-200-30BR	18	540-803-23	38	582-150-41GU	33	582-180-40B-S	28	582-533-04	40
287-200-30BR	23	540-803-30	38	582-150-41GU	35	582-180-40B-S	33	583-214-16LL	30
287-200-30BR	28	540-803-50	38	582-150-41GUB-S	18	582-180-40B-S	35	583-228-16FS	30
287-200-30BR	39	540-813-18	38	582-150-41GUB-S	33	582-180-41B	28	583-228-16LL	30
287-200-50	31	540-813-23	38	582-150-41GUB-S	35	582-180-41B	33	583-229-16FS	30
287-200-50	39	540-813-30	38	582-150-42GU	18	582-180-41B	35	583-229-16LL	30
287-205-30	31	540-813-50	38	582-150-42GU	23	582-180-41B-S	28	583-250-16G	30
287-205-30	39	540-880-01	38	582-150-42GU	33	582-180-41B-S	33	583-250-40G	30
287-205-30BR	18	540-880-02	38	582-150-42GU	35	582-180-41B-S	35	583-256-16FS	30
287-205-30BR	23	540-880-04	38	582-150-42GUB-S	18	582-180-42B	28	583-256-16LL	30
287-205-30BR	28	540-880-05	38	582-150-42GUB-S	23	582-180-42B	33	583-258-16LL	30
287-205-30BR	39	540-880-13	38	582-150-42GUB-S	33	582-180-42B	35	583-278-16LL	30
287-205-50	31	540-890-01	38	582-150-42GUB-S	35	582-180-42B-S	28	583-280-00	30
287-205-50	39	540-890-02	38	582-150-43GU	18	582-180-42B-S	33	601-103-00HD2	9
287-210-30	31	540-890-04	38	582-150-43GU	23	582-180-42B-S	35	601-103-00HD2	38
287-210-30	39	540-890-10	38	582-150-43GU	33	582-180-43B	28	601-103-12HD2	9
287-210-50	31	540-890-14	38	582-150-43GU	35	582-180-43B	33	601-103-12HD2	38
287-210-50	39	582-150-00GUB	8	582-150-43GUB-S	18	582-180-43B	35	601-103-30HD2	9
287-215-30	31	582-150-00GUB	17	582-150-43GUB-S	23	582-180-43B-S	28	601-103-30HD2	38
287-215-30	39	582-150-00GUB	22	582-150-43GUB-S	33	582-180-43B-S	33	Belo/2-PB02N	40
287-215-30BR	18	582-150-02GUB	8	582-150-43GUB-S	35	582-180-44B	28		
287-215-30BR	23	582-150-02GUB	28	582-150-44GU	18	582-180-44B	33		
287-215-30BR	28	582-150-21GU	17	582-150-44GU	33	582-180-44B	35		
287-215-30BR	39	582-150-21GUE	22	582-150-44GU	35	582-510-05	31		
287-215-50	31	582-150-24GU	11	582-150-44GUB-S	18	582-511-05	31		
287-215-50	39	582-150-24GU	17	582-150-44GUB-S	33	582-514-05	31		
287-220-30BR	18	582-150-24GUE	11	582-150-44GUB-S	35	582-515-05	31		
287-220-30BR	23	582-150-24GUE	22	582-150-45GU	32	582-516-05	31		
287-220-30BR	28	582-150-26GU	17	582-150-46GU	32	582-517-05	31		
287-220-30BR	39	582-150-30GU	17	582-150-47GU	32	582-518-05	31		
287-225-30BR	18	582-150-39GU	17	582-150-48GU	32	582-531-02	18		
287-225-30BR	23	582-150-39GUE	22	582-150-49GU	32	582-531-02	23		
287-225-30BR	28	582-150-40GU	18	582-150-60GU	40	582-531-02	28		
287-225-30BR	39	582-150-40GU	23	582-180-00B	8	582-531-02	31		
287-230-30BR	18	582-150-40GU	33	582-180-00B	28	582-531-02	40		
287-230-30BR	23	582-150-40GU	35	582-180-21	27	582-532-03	18		
287-230-30BR	28	582-150-40GU	35	582-180-22	27	582-532-03	23		
287-230-30BR	39	582-150-40GU	35	582-180-24	11	582-532-03	28		
499-198-00	17	582-150-40GUBE-S	23	582-180-24	27	582-532-03	31		
499-198-00	22	582-150-40GUBE-S	33	582-180-26	27	582-532-03	40		
499-199-00	17	582-150-40GUBE-S	35	582-180-38	27	582-533-04	18		
499-199-00	22	582-150-40GUB-S	18	582-180-39	27	582-533-04	23		
540-280-50	8	582-150-40GUB-S	33	582-180-40B	28				



· WORLD WIDE DISTRIBUTION NETWORK ·



TONTARRA Medizintechnik GmbH
Daimlerstr. 15 · 78573 Wurmlingen/Germany
Tel: +49(0) 74 61/9 65 76 -0
Fax: +49(0) 74 61/9 65 76 -26
info@tontarra.de

www.tontarra.de

All rights are reserved. Technical alterations are possible. This folder may be used for no other purpose than offering, buying and selling of our products. No part may be copied or reproduced in any form. In the case of misuse, we retain the rights to recall our catalogs and pricelists and to take legal actions.
999-351-03E · 09.2020