

# ENDO INDONESIA

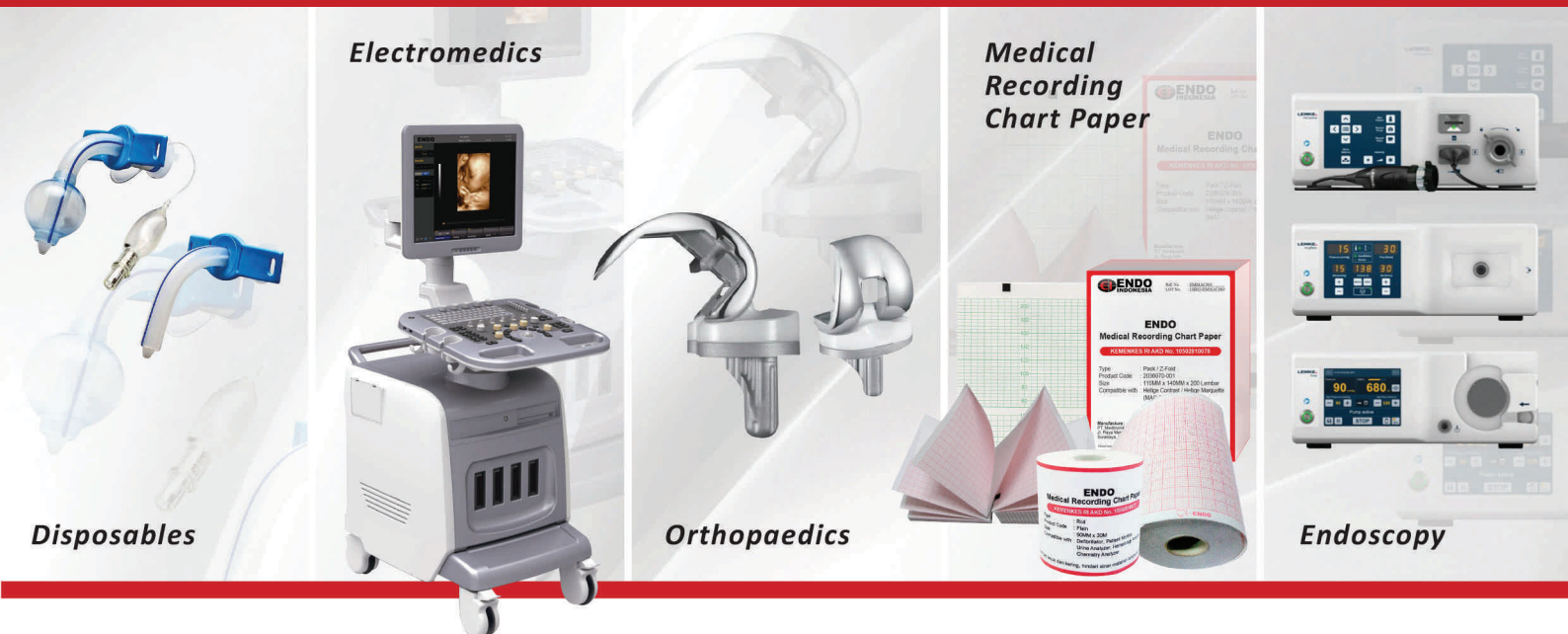

## PRODUCT CATALOG

Medical Distributor and Manufacturer



**LKPP** *ecatalogue*  
Belanja Cepat Cara Tepat  
Lembaga Kebijakan  
Pengadaan Barang/Jasa Pemerintah



EDISI EI-101



## PT. ENDO INDONESIA

ENDO INDONESIA was founded in 2006 as a company engaged in importation and distribution of Medical Devices. Today, among many others, our product portfolio consists of Electromedical Devices, Instruments, Disposables, Orthopaedic Implants, and accessories.

### Our Vision

"Improving health care of Indonesian society by providing good quality products at affordable prices."

### Our Mission

"Consistent development and continuously increasing employee's well-being while maintaining integrity in daily routines."

### Our Value



#### Improving Healthcare

Providing high quality products at affordable prices



#### Qualified Personnels

Experienced staffs in their respective fields



#### Networking

Through doctors, hospitals, distributors, resellers



#### Fast Delivery

Most products are ready in stock

# Product Catalog 2020

Company Profile	Page 02
Exclusive Distributors	Page 03
Electromedics	Page 04-10
Endoscopy	Page 11-13
Disposable	Page 14-20
Orthopaedics	Page 21-26
Medical Recording Chart Paper	Page 27

## Exclusive Distributors





**Bell Plus Audiometer**

Basic Diagnostic Audiometer.  
Output : AC L+R, BC, Insert Masking  
Test battery : Pure Tone Audiometry, Autothreshold.



**Harp Plus Audiometer**

Advanced Diagnostic Audiometer.  
Output : AC L+R, BC, FF L+R, Insert Masking. Test battery : Speech Audiometry, Autothreshold, ABLB, SISI, DLI, Tone decay, Strenger, QuickSIN (opt), TEN test (OPT).



**Piano Plus VRA Audiometer**

Advanced Clinical Audiometer. Piano Plus VRA also features pediatric audiometry capabilities. It can become the heart of a traditional or video-VRA system. High Frequency, Bekesy & Masking Level Difference.



**Spirobank II Advanced Spirometer**

Memory of up to 10.000 test. Real time tests with wireless Bluetooth, connection to PC. FVC, VC, pre and post tests with main parameters enabled (FEV1, FEV1%, PEF, PEF2S-7S% FET, EVOL, IVC, IC, ERC).



**Spirolab Spirometer**

7 inch Touchscreen, All in one portable Desktop Spirometer. Memory of up to 10.000 test. Spirometry test : FVC, VC, IVC, MVV, Pre / Post Bronchodilator comparison with a wide range of selectable parameters.



**Smart One FEV1 and Peak Flow Meter**

Ideal for monitoring respiratory illnesses and in the self management of Asthma, COPD, Lung Transplant carem Cystic Fibrosis and for use in Clinical Trials.



**Life Point Pro AED Automated External Defibrillator**

Operating modes : Automatic.  
Energy selection (Joule) :  
Adult 150~150~200  
Child 50~50~50.  
Available in Bahasa Indonesia.



**Life Point bPlus AED Automated External Defibrillator**

Operating modes : Automatic.  
Energy selection (Joule) :  
Adult 150~200~200  
Child 50~50~50.  
Available in Bahasa Indonesia.



**Biphasic Life Point Plus**

Operating modes : Manual / AED / Synchronous. Energy selection (Joule): 2~3~5~7~10~20~30~50~70~100~150~200~220~270. Monitor type : Color TFT LCD / 7 inch / 800x480 resolution.



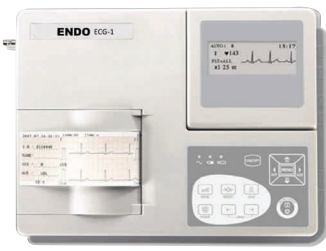

**ENDO ECG-1**  
*Electrocardiograph 1 Channel*

Single channel ECG is accurate, portable and affordable. User friendly design, streamlined workflow and automatic baseline adjustment to optimize printing position.



**ENDO ECG-3**  
*Electrocardiograph 3 Channel*

Smart ECG are high quality and affordable three channel ECG units. Compact and light design makes it portable for any work situation.



**ENDO ECG-12**  
*Electrocardiograph 12 Channel*

Twelve channel ECG. 7 inch high resolution color touch screen. User friendly design, streamlined workflow and accurate clinical performance.



**ENDO PM-1**  
*Patient Monitor*

10.4" high resolution color TFT-LCD screen. Built-in rechargeable li-ion battery. Parameters: 3/S-lead ECG, RESP, SpO2, NIBP, PR, 2-TEMP.

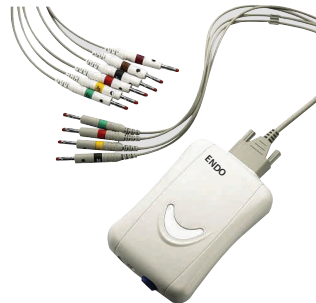

**ENDO PC-ECG-1**  
*PC Electrocardiograph*

12-lead wired / wireless PC ECG. User friendly design, streamlined workflow and accurate clinical performance.



**ENDO Exercise ECG Test**  
*Treadmill Stress Test*

ENDO Exercise ECG Test Stress ECG function provides standard as well as unlimited user defined stress protocols which en.



**ENDO PO-1**  
*Handheld Pulse Oximeter*

As a handheld pulse oximeter, ENDO PO-1 is designed to serve the needs of both long term monitoring and spot check. Parameters : SpO2



**ENDO PO-2**  
*Fingertip Pulse Oximeter*

ENDO PO-2 Finger Oximeter delivers a fast, reliable oximetry in a very handy, finger-tip solution by combining the monitor and the sensor into one unit. ENDO PO-2 is small in size, pulse rate measurement, bar graph display.



**ENDO FD-1**  
*Fetal Doppler*

Sonotrax Ultrasonic Pocket Doppler superior sensitivity, high fidelity sound, easy to use, large backlit LCD. Support 2MHz waterproof probes.

**ENDO AM3**  
*Anesthesia Machine*



Advanced anesthesia machine with high technology, support a variety of patients. Suitable for neonate, pediatric & adult. 12" TFT color touch screen comply with multi parameter monitoring. Meet low flow requirement by multi parameter monitoring. Electronic flowmeter of high accuracy & intuitive displaying. Integrated high temperature sterilization CO2 absorber system, excellent ergonomic breathing circuit, with heating and bypass function. Safe & reliable gas system. CE marked, meet EU clinical requirement.

**ENDO ANM2**  
*Anesthesia Machine*



Multifunction anesthesia machine, more accurate. Internal 8.4" TFT screen. Integrated CO2 absorber system, easy to disassemble and assemble components, clean and maintain. Suitable for pediatric and adult. CE marked, meet EU clinical requirement.

**ENDO AM831**  
*Anesthesia Machine*



Display : 4.2" LCD screen.  
Patient : pediatric and adult.  
Dual Vaporizer : halothane and isoflurane.

Ventilator :  
Type and drive mode : integrated electronically controlled pneumatically driven ventilator. Ventilation mode : IPPV, manual, spontaneous.

**ENDO AM832**  
*Anesthesia Machine*



Display : 5.6" LCD screen.  
Patient : pediatric and adult  
Dual Vaporizer : Isoflurane and Sevoflurane.

Ventilator :  
Type and drive mode : integrated electronically control pneumatically driven ventilator. Ventilation mode : IPPV, IPPB, SIGH, manual / spontaneous.

**ENDO HD-1**  
*Hemodialysis Machine*



12.1 inch large color LCD touch screen. Intelligent self diagnosis and alarm system. In the course of treatment, the machine has self diagnosis and self detection function. Alarm cause is literature and acousto-optic prompted, convenient to remind the clinical staff to correct and deal with alarm timely.

Multi-lingual and open system, compatible to different brand of dialysis consumables & concentrate formulation for dialysate.

**ENDO High Flux**  
*Hemodialyzer*



Membrane material medical grade polyether sulfone (PES). Housing and blood caps material medical grade polycarbonate (PC). Potting sealants material bi-component polyurethane sealants (PU).

Inner diameter of membrane 200 um. Wall thickness of membrane 40 um. Maximum operation pressure 66.5/500kPa/mmHg.

**ENDO Ventilator SH-300  
ICU Ventilator**

Great visibility, SH-300 is quipped with a large 10.4" full color display. The high resolution display provides for a flexible graphics menu combining respiratory curves, loops, and numerical data of physiological parameters.

Expiratory valve, with heating function, the expiratory valve protects the device from condensed water accuracy of the flow sensor is ensure.

**ENDO NV8  
Neonatal Ventilator**

Specially designed for neonates, NV8 provides and diversified non invasive nasal ventilation modes with advanced apnea wakeup function.

Accurate and safe fresh gas delivered by iFlow Intelligent Closed loop Control System to protect fragile new life. User-friendly operating system with easy clinical practice to facilitate medical staff. Integrated ventilation solutions providing SNIPPV / NIPPV, NCPAP and HFNC modes for safe ventilator weaning. Minimum neonatal weight : 0.5 Kg.

**ENDO Ventilator V1  
Portable Emergency Ventilator**

5.6" TFT color screen, patient type : adult and pediatric.  
Ventilation mode : VCV, SIGH, SIMV+VCV, CPAP, SPONT.  
Weight and dimension :  
NW : 6.6 kg. GW: 7 kg.  
Dimension : H480xW260xD420mm  
Trolley (optional).  
Backup chargeable battery.

**ENDO Ventilator V2  
ICU Ventilator**

ENDO Ventilator V2 is a mechanical ventilator designed to provide invasive & non-invasive, continuous or intermittent, respiratory support for adult, pediatric, and neonatal patients. Turbine based ventilator.  
Display size :  
12.1 inch TFT Touch Screen  
18.5 inch TFT Touch Screen (optional)  
Resolution (H) x (V) : 1080\*1920 pixels. Modes invasive ventilation : VCV, PCV, VSIMV, PSIMV, CPAP/PSV, PRVC, V+SIMV, BPAP, APRV, Apnea Ventiation.

**ENDO EI-2  
Portable BW Ultrasonography**

The latest platform & more advanced chip-set: brings you better image quality and features at less cost in a more compact box

Advanced technologies : i-image (Intelligent image optimization), THI (Tissue Harmonic Image), SRA (Speckle Reduction Algorithm), Compound imaging

Rotatable 12 inch LED (0-30°): tailor to different viewing angles. Ultra compact & ultra light. Easy to carry. Excellent PW resolution.

**ENDO EI-3  
4D Ultrasonography**

Light probe releases doctor from scanning fatigue. Quite probe vibration free and noise free probe allows better care for mother and fetus. Smart function the latest technology compound i-image, SRA, etc. provide super image. Fast speed 4D volume rate reveals fetal movement in real time.

19" LCD monitor, 4 Probe connectors and include : convex probe, transvaginal probe and 4D volume probe.

**AMP** *all*



**SP-8800**  
Syringe Pump

Numerical keypad, simple, fast and convenient syringe installation, color LCD. Open system up to 10 syringe brands can be calibrated in a single unit.



**IP-7700**  
Volumetric Infusion Pump

Numerical keypad, various display, user friendly. Open system up to 10 IV set brands can be calibrated in a single unit.

**Kayto**



**RT-9700**  
Semi Auto Chemistry Analyzer

7" color LCD touch screen and keypad, Semi-auto Chemistry Analyzer. Reagent open system support flow cell and cuvette mode.

**ZERONE**



**Zeus-400 Upgraded Version**  
Electrosurgical Unit

Zeus 400 upgraded version provide safety flexibility and convenience, supported by powerful and stable technology. 10 storages are available by using storage function. Bipolar cut function is available.



**Zeus Vision**  
Electrosurgical Unit

Color graphic user interface. Best safety with feedback system. All touch screen system and key, Diversity of feature bipolar. Bipolar cut function is available.

**mindray**



**BC-2800**  
Hematology Analyzer

Fully automated, compact, flexible, and cost effective. Three part differentiation of WBC, 19 parameters and 3 histograms, Throughput : 30 samples per hour.

**Accumax**



**Accumax Smart and Accumax Stand**  
Micropipette

Light and smooth plunger action. Locking mechanism preventing accidental volume changes during pipetting. Clear four digit display for small increments and wider volume selection options. Pipette handle has coating of Thermoplastic Elastomer to prevent transfer of body heat to internal parts for high accuracy even on continuous use. Volume display is always visible while pipetting. Shelf mounting stand for efficient handling and storage.

**ENDO**  
INDONESIA



**ENDO Pro**  
Micropipette

Minimum size with maximum accuracy. Two stop plunger. Fully Autoclavable. Beautiful color coded for easy volume identification. Calibration through EN ISO 8655.





**ENDO FM-1**  
*Fetal Monitor*

With its elegant design, foldable screen, and enhanced functionality, FM-1 fetal monitor would address the needs of obstetrical departments in both clinics and hospitals.



**ENDO 7A-23B**  
*Suction Pump*

Electric suction apparatus adopts completely plastic panel design, low noise, oil pump free. Reservoir volume: 2500ml/pc, 2 pieces, glass.



**ENDO 7E-C**  
*Portable Phlegm Suction Pump*

Portable phlegm suction pump, easy to carry, with heat release system. Reservoir volume : 1000ml, 1 piece.



**ENDO C3A**  
*Video Colposcope*

LED cold lighting system reproduces an original view of tissue. Advanced and fast auto focusing system ensures clear image. Remote capture control and user friendly keyboard layout for easy operation.



**ECG Bulb & ECG Limb Clamp**  
*Accessories*

Reusable praecordial electrode for ECG. Ball material plastic. Reusable peripheral clamp electrodes for ECG. Electrode material coating Argento Clorurato. Connection universal screw 4mm and clip



**ENDO ECG Cable**  
*Patient Cable Compatible*

Patient cable compatible (Burdick, Fukuda Denshi, Kenz, Nihon Kohden, Schiller, Cardioline, GE-Marquette, Mortara, Philips/HP, Quinton).



**Skin Graft Mesher**  
*Surgical Instrument*

Skin Graft Mesher is a surgical instrument used for skin transplantation. Single cutter cuts skin graft into geometrical shaped mesh and enlarge skin surface. Graft expansion predetermined by graft carrying plates, eliminating need to change cutter during operation. Graft thickness adjustment feature allow expansion on thin and thick grafts.



**Dermatome**  
*Surgical Instrument*

Dermatome is a device used for skin transplantation. It can be used with three possible technologies battery, electro motor and pneumatic. User friendly, battery powered high torque motor design. Removable special batteries make steam sterilization possible. Ergonomic and weight balanced design make it easy to handle.

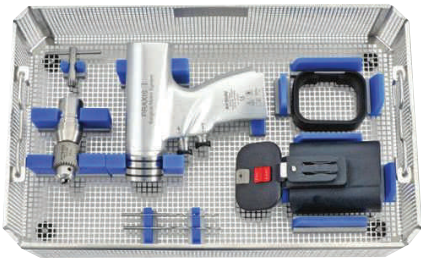

**Praxis  
Orthopedic Set, Drill Set**

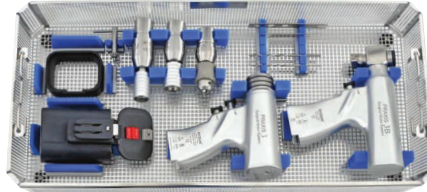

**Praxis  
Orthopedic Set, Basic Set**



**Praxis  
Orthopedics Set, Large Set**



**Praxis  
Reciprocating Saw Set**



**Praxis  
Sagittal Saw Set**



**Praxis  
Sternal Saw Set**

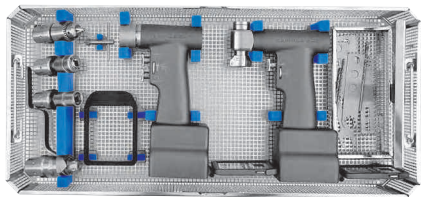

**Karinca  
Orthopedic Set**

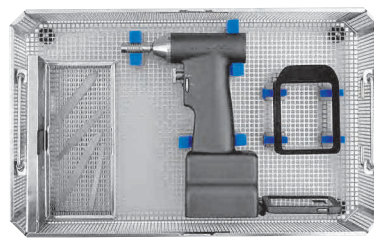

**Karinca  
Reciprocating Saw Set**



**High Speed Motor  
Neuro System**

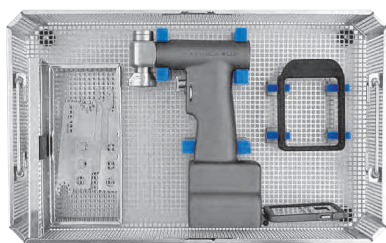

**Karinca  
Sagittal Saw Set**

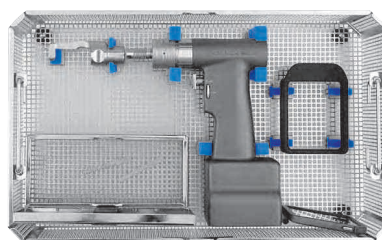

**Karinca  
Sternal Saw Set**



**High Speed Motor  
HSM-2**



Digestive



Urology



Gynecology



ENT



Arthroscopy



Electrosurgical Unit  
(Bipolar in Saline Mode)

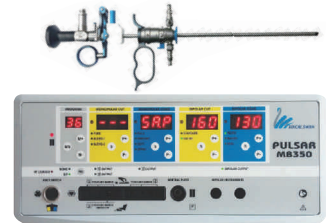

Pulsar MB350 provided with all the performance needed for the monopolar or bipolar use in open or laparoscopic surgery



Full HD Camera



Co2 Insufflator



Multi-Indication Pump

## LEMKE.

Laparoscopy, Urology,  
Hysteroscopy, Arthroscopy

LEMKE draws on a wealth of experience collected over more than 40 years in the development of medical-technical devices for Minimally Invasive Medicine. Behind the brand is WOM - a strong partner considered one of the leading international companies in the field of Minimally Invasive Medicine.



## NELIS

Glove Port

Glove Port holds back incisions edges to insert operative instruments and endoscope and endoscope into the body through the cook caps. Edges of the incisions to insert the operative instruments and the endoscope into the body through cook caps.



Pneumatic Lithotripter  
and Uroflometry



digiFlow - ST2  
Uroflometry

Fully automatic or manual operation. User friendly system. Uses in built thermal technology printer. The printer requires no maintenance, no ink refilling. Prints crisp and clear high resolution printouts.



digiFlow - 4  
Uroflometry

Fully automatic. Uses PC's USB port for communication with the hardware. Prints crisp and clear colourful or greyscale printouts on any color deskjet or laser printer installed on the PC.



Lithosplit 4.1 Digital  
Pneumatic Lithotripter

Easy to use electronic control is provided to set a desired energy level from 1 to 10. This wide range of control allows a surgeon to disintegrate stone of any hardness and size easily.





## Endoscope Camera



**ENDO EC-1**  
*Portable Endoscopy Camera*

Easy and practical operation. Simple panel adjustment can get a nice image effects. White balance support manual or automatic adjustment. Camera 1/3" CCD waterproof. Light source LED lamp.



**ENDO EC-3**  
*Medical Endoscope Cold Light Source*

Color temperature 6500L. Lamp life up to 20000 hours. 180VA LED lamp. Video system PAL/NTSC. Maximum illuminance output 1500lm. Image sensor CMOS. Automatic white balance.



**ENDO Portable Camera**  
*Portable Camera System*

Sensor camera 1/3" CCD specifically designed for use with applications Endoscopic Laparoscopy. Combined with build in high intensity LED lighting. The device offers optimal image quality.



**Detro Forte, OPA, Enzym**  
*Disinfectant and Enzymatic*

High level disinfection of surgical instruments, flexible and rigid endoscopes. Enzymatic provides pre cleaning for medical devices and endoscopes and all kinds of surgical instruments.



**Detrowash**  
*Endoscope washer & Disinfector*

Disinfection compatibility system, suitable for use with liquid disinfectants for all endoscope devices. Suitable for single use and ready to use disinfectant. Double tank and double scope system.



## Disposables Flexible Instrument



## SonoScape Flexible Endoscopy



**HD-350**



**HD-500**



**HD-550**

**HD-350, HD-500, HD-550**  
*Video Endoscopy System*

High definition image and 60 frames per second progressive scan video. Two different modes of structure enhancement. Flexible picture in picture function. Built in workstation with highly customer defined reporting, patient data management, image capture, video recording and data playback. Hot plugging of endoscope. Variable Intelligent Sustaining Technology (VIST).



**SEESHEEN**

see the endo-sheen Flexible Video Endoscopes



**Flexible Video Ureterorenoscope**



**Flexible Video Bronchoscope**



**Flexible Video Cystonephroscope**

**Potent®**



**Holmium Laser Therapeutic Laser Therapeutic**

Dual insurance laser. Unique sealing techniques patent. Sound mute environment friendly water cooling system, high efficiency, long time use. 0.1J step length adjustment, wide range alternative energy feedback.

**MED FIBERS**

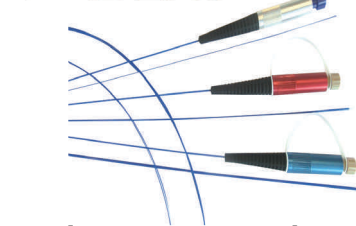

**Holmium Laser Fibers Fiber**

MED-Fibers, Inc. with its key management and the combined optical glass, and optical fiber experience is your partner for the next generation of technology. Provides you with the highest standard laser.

**blue endo international**



**Morcellator Abdominal Hysterectomy**

The special full load of 1.5 Nm allows a controlled, powerful cutting of tissue with a very low drive. Ergonomic design, grip module lies well in the hand and its weight is balanced.

**TROPIAN TECH**



**Disposable Trocar Trocar**

Tropian is designed to enhance surgeons and assistants of health. The key features of this product including the filter. A distinctive aspect of our product is triple filter system. Good grip, ergonomic designed trocar.

**AYGUN®**  
SURGICAL INSTRUMENTS CO., INC.



**Shaver for Arthroscopy Endoscopy Shaver**

Graphical LCD on the power console shows adjusted motor speed, rotation direction, irrigation pump flow rate, pedal motor connection failure indicator. Barled display shows speed demand.

**EZLIG**



**Multi Band Ligator Multi Band Ligator**

Used for ligating esophageal varices combined with Endoscope. Post installation of the bands makes the field clear. Precise ligation, obvious release resistance, easy to operate, Bands release reminds by feeling.



**Oxy Set**  
**Nasal Cannula**

Oxy Set is suitable for easy application and efficient administration of oxygen for greater comfort of the patient. Twin prong / nasal tips are designed to ensure equal volume of oxygen to both the air passages.



**Flexi Mask**  
**Oxygen Mask**

Flexi Mask is designed for convenient oxygen therapy. Moulded face mask is manufactured from non-toxic, non irritant medical grade PVC. Swivel connector for convenience of attachment to the oxygen tube.



**Hi Mask**  
**Non Rebreathing Mask**

High concentration oxygen therapy. Equipped with soft, transparent and odour free mask for greater patient comfort. Light weight reservoir improves the oxygen efficiency and patient comfort.



**Oxy Lock**  
**Venturi Mask**

Variable venturi system to ensure accurate concentrations of oxygen with single unit. Transparent air entertainment mask with soft anatomical form with easily adjustable elastic strap.



**Aeromist**  
**Nebulizer Mask**

Soft, clear aerosol mask with anatomical form is ideal for long term use. Gently rolled, feathered edges with integrated nose bridge for extra comfort. Nebulizer rate 3cc / 10 mins.



**Resq Bag**  
**Manual Resuscitators**

Resq Bag kit consists of a Silicone Manual Resuscitator, Multichannel Kink Resistant Oxygen Tubing, Reservoir Bag & Silicone Mask. Silicone Resuscitator provides excellent bag re-expansion property.



**Suction Catheter**  
**Endo Bronchial Suction Catheter**

Suitable for removal of secretions from mouth, trachea and bronchial tubes. Manufactured from non-toxic, non irritant medical grade PVC. Distal end is open with one lateral eye.



**Guedel Airways**  
**Oropharyngeal Airway (OPA), Mayo**

Guedel Airways are designed to maintain an unobstructed oropharyngeal airway during or following general anaesthesia and in patients who are unconscious for other reasons.



**Silko Mask**  
**Manual Resuscitators**

Silko mask for resq bag, manual resuscitator. Manufactured 100% silicone material. Spare mask. Size : 0, 1, 2, 3, 4, dan 5. Autoclavable mask suitable for repeated use. Individually packed.



### **Endotracheal Tube Plain Endotracheal Tubes**

Manufactured from thermosensitive material readily conforming to body contours at body temperature. Radio-opaque line throughout the tube length to facilitate exact location of the tube.



### **Endotracheal Tube (Cuffed) Endotracheal Tubes**

Thermo sensitive tube softens at body temperature to conform to the anatomy of the respiratory tract. Kink resistant inflation tube ensures patient safety during cuff inflation and deflation.



### **Catheter Mount "T" Connector**

Double swivel elbow connector with suction port & cap provides better flexibility, easy accessibility & provide comfort to patient during suction. Collapsible corrugated tubing is inert to all anaesthetic gases & reagents.



### **Epidural Kit Epidural Anesthesia Kit**

EPIDURAL/TUOHY NEEDLE : Tuohy type needle is provided with clear depth marking for accurate insertion depth reading, polished inner bevel edge minimize the risk of catheter shearing.



### **Intra Cath-2 Intra Venous Cannula**

I.V. Cannula with injection port. Injection port with non return valve is provided for additional medication. Port caps are colour coded for instant size identification. Sizes: 14,16,18,20, 22 & 24G.



### **Micron Intra Venous Cannula**

Neonate I.V.Cannula. Main body is specially designed with projection for low point gap to facilitate better maneuvering. Specially designed clips provided for better maneuvering.



### **Blood Administration Set Blood Transfusion Set**

Cylindrical drip chamber provided with 200 micron filter to prevent passage of any clot into the chamber. Sharp non-vented spike suitable for blood bags and all type of standard blood containers.

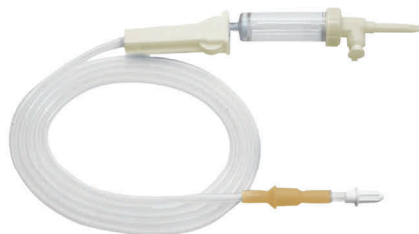

### **Vented Infusion Set Infusion Set**

Sharp piercing spike for easy insertion in I.V. container. Cylindrical collapsible drip chamber to visualise the flow rate. Disc type fluid filter to filter any particulate matters in the I.V. fluid.



### **Transflow Infusion Set Type "Y"**

Specially designed vented infusion set with latex free "Y" injection set along with needle-prick protection shield. Unique rotating type luer slip connector. Compatible with all infusion pumps.



**Pedia Drip**  
**Infusion Set with Burette**

Burette chamber is made of bio compatible medical grade transparent polymer, suitable for infusion of all types of fluids. Patent design hanger facilitates the hanging of complete device on the I.V. stand.



**Exteena**  
**Needle Free Devices**

Needle free devices prevent thrombotic occlusion in I.V line & inhibit microbial colonization. Secure fitment to I.V Cannula, I.V Set, Extension Lines, CVC Closed system controls infection/air embolism.

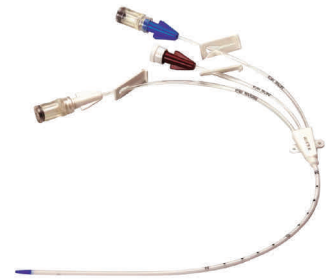

**Centro**  
**Central Venous Catheter Kit**

Manufactured from specially formulated & biocompatible PU material. Specially designed soft tip catheter to make the insertion easy & non-traumatic. Based upon much preferred Seldinger technique.



**Bi-Valve**  
**Three Way Stop Cock**

Three way stop cock are suitable for use during pressure infusion & invasive blood pressure monitoring. Manufactured from medical grade, clear transparent polycarbonate. Three arm handle is easy to operate.



**Vein-O-Line**  
**Three Way with Tube**

Low pressure large bore extension line. Used primarily to connect the transducer system to the indwelling catheter. Three way stop cock may be used for blood sampling or extra medication.



**PM-O-Line**  
**Perfusor Line**

Multipurpose extension line suitable for Angiography, Arterio graphy, C.V.P. measurement etc. Suitable for high pressure monitoring and for connection between syringe infusion pump and patient.



**Yankaur Suction**  
**Yankaur Suction**

Complete set is provided with Yankaur Suction Tip mounted on two meter long ribbed tube provided with Universal connector at both ends. Ribbed tube is kink resistant and has the strength to withstand the suction.



**Vaccu Suck Suction Set**  
**Yankaur Suction**

Moulded Yankaur Suction handle attached with 2.5mtr tube. Vent port is permanently closed with tight fit sleeve, which can be removed with small incision by blade to change over to vent control system.



**Romo Vac Set**  
**Close Wound Suction Unit**

Redon drain catheters are provided with radio opaque line and satin smooth eyes. Connecting tube is kink resistant and is provided with additional strength to withstand the suction.





### **Chest Drainage Catheter Drainage Catheter**

Thoracic Drainage Catheters are most suitable for post operative drainage after cardio-thoracic and thoracic surgery. Catheters are marked at every 2 cm from the last Eye to ascertain the depth of placement.



### **Thoracic Trocar Catheter Catheter with Trocar**

Specially designed for quick non operative pleural and chest drainage for the relief of chest conditions such as tensions pneumothorax. Catheter manufactured from medical grade PVC is snugly fitted over the trocar.



### **Romo Seal Water Seal Drainage System**

Easy to read graduation help to determine the drain volume precisely. Clearly marked initial level ensures the under water seal. Kink resistant large bore tubing facilitates unrestricted flow.



### **Tracheostomy Tube (Cuffed) Tracheal Tubes**

Soft low pressure cuff dynamically adjusts the pressure at the point of contact during the breathing cycle. Radio opaque blue line enable to confirm the correct placement of the tube in trachea.



### **Tracheostomy Tube Plain Tracheal Tubes**

Made of thermosensitive medical grade PVC which provide sufficient hardness during insertion. Being light in weight & non irritant it avoids the inflammation around tracheostomy. Soft flexible flange helps easy fixation.

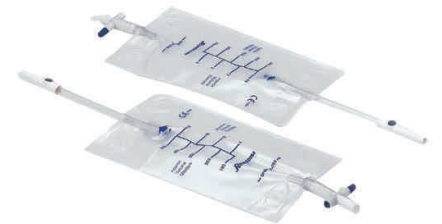

### **Leg Bag Urine Leg Bag**

Suitable for day & night use for incontinence. Manufactured from soft clinical grade PVC sheeting. Available with "T" type bottom outlet. Non return valve to prevent the backflow of urine.



### **Urine Collecting Bag Urine Bag**

Closed urine drainage system for short and long term use. Manufactured from soft clinical grade PVC sheeting. Reinforced eyelets allow easy hanging and provide maximum protection against tearing.



### **Urometer 250 ml Urine Bag (Measured Vol Chamber)**

Urometer has been designed for measurement of hourly urine output. 150cm long kink resistant tubing ensures the unrestricted flow of urine. Completely closed circuit eliminates the risk of contamination.



### **Urometer 500 ml Urine Bag (Measured Vol Chamber)**

500ml transparent chamber has four line measuring sections to measure the accurate & precise volume of the urine. Collection chamber is provided with hydrophobic filter to minimize the risk of urinary tract infection.



**Foley Baloon Cath 2 Way  
Uro Catheter**

Manufactured from natural rubber coated with silicone to eliminate the risk of encrustation. Hard valve ensures easy inflation and deflation of balloon.



**Male Catheter  
Kondom Catheter**

Penile Sheath/External Catheter. Male Cath is specially designed for urine incontinence for day and night use in male patients. Manufactured from 100% latex for soft and gentle feel.



**Nelaton Catheter  
Urine Drainage Catheter**

Nelaton catheters are used for short term bladder catheterisation. Manufactured from non-toxic, non irritant medical grade P.V.C. compatible with catheter lubricants.



**Romolene  
Nasogastric Tube (NGT)**

Radio opaque line is provided throughout the length to facilitate the accurate location. Proximal end is provided with dual type universal funnel shape connector & female luer mount with closure cap.



**Infant Feeding Tube  
Infant Feeding Tube**

Proximal end with female luer mount for easy connection to enteral feeding bag connector or luer mount/luer slip syringe. Low friction tubing and super smooth tip ensures trauma free intubation.



**Feeding Bag  
Feeding Bag, Gravity Bag**

Specially designed 1.2 Lit. capacity bag for feeding purpose. An ice pouch is provided with the bag for preserving the food for longer period. A transfer set is directly connected to the bag for easy feeding.



**Mucus Extractor  
Infant Mucus Extracting Device**

Used for aspiration of secretion from oropharynx in newly born babies to ensure free respiration. Clear transparent container permits immediate visual examination of the aspirate.



**Respirometer  
Breathing Exerciser**

Innovative system to exercise respiration through inspiration. Three spheres rise proportionately to the inspiration exerted. Innovative design, can be dismantled into parts for cleaning & disinfection.



**Klik Clamp  
Clamping Devices, Umbilical Clamp**

Suitable for clamping the umbilical cord of new born baby immediately after the birth. Provided with double purpose security lock click to indicate the correct locking and protect against accidental reopening.



**Monopolar Pencil**  
**Electrosurgical Unit : ESU**

Electrocauterization is the process of destroying tissue using heat conduction from a metal probe heated by electric current.

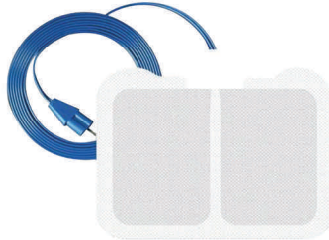

**Disposable ESU Plate**  
**Electrosurgical Unit : ESU**

Designed for optimal conductivity and adhesive. Due to the optimal hydro-gel of low impedance characteristics removal of the Hot spot area.

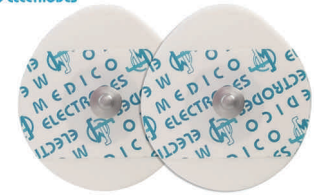

**Medico ECG Electrode**  
**ECG Electrode**

High chloride liquid gel electrodes hydrate the skin and produce fast, clear, tracings. Specially formulated solid gel delivers excellent results with no post procedural clean-up.



**Circular Stapler III**  
**Surgical Stapler**

The special design of the outer ring prevent anastomotic tissue from excessive squeezing. If there's no edema of the tissue, the red pointer in the safety window must be aligned with the center line of the green zone before firing.



**PPH Stapler III**  
**Surgical Stapler**

This type of three-row PPH stapler comes with exceptional hemostatic effect. Anastomotic wound is dry and has no bleeding after firing. No longer need to manually suture absence of special circumstances.



**Linear Cutter**  
**Surgical Stapler**

The cutter can be replaced to ensure the sharp cutting. Meanwhile, it can reduce the possibility of implantation metastasis in the tumor resection. The staple line is longer than the cutting line for effectively avoiding errhysis.



**Auto Linear**  
**Surgical Stapler**

Basic length (+/-10mm):395,400, 405  
Effective length (+/-5mm):30,45,60,90  
Staple height (+/- 0.3mm):3.8 , 4.5



**Vacuum Tubes Xinle**  
**Vacuum Tubes**

- K3EDTA 3ml Glass
- K3EDTA 3ml Glass, Softneedle
- K3EDTA 2ml Glass
- Plain / Serum 3ml Glass
- Plain / Serum 5ml Glass
- Plain / Serum 10ml Glass



## ENDO Vacuum Tubes

Nama Item	Spesifikasi	Volume	Additive	Qty / Box	Qty / Karton
K2.EDTA 3 mL - Glass	Ø 13x75 mm	3 ml	EDTA K2	100	1800
K2.EDTA 2 mL - Glass	Ø 13x75 mm	2 ml	EDTA K2	100	1800
K3EDTA 3 mL - Glass	Ø 13x75 mm	3 ml	EDTA K3	100	1800
K3EDTA 3 mL - Glass, for Soft Needle	Ø 13x75 mm	3 ml	EDTA K3	100	1800
K3EDTA 3 mL - Plastic	Ø 13x75 mm	3 ml	EDTA K3	100	1800
K3EDTA 2 mL - Glass	Ø 13x75 mm	2 ml	EDTA K3	100	1800
K3EDTA 0.5 mL - Glass	Ø 13x75 mm	0.5 ml	EDTA K3	100	3000
Plain / Serum 3 mL - Glass	Ø 13x75 mm	3 ml	Plain / No Additive	100	1800
Plain / Serum 3 mL - Plastic	Ø 13x75 mm	3 ml	Plain / No Additive	100	1800
Plain / Serum 5 mL - Glass	Ø 13x75 mm	5 ml	Plain / No Additive	100	1800
Plain / Serum 5 mL - Plastic	Ø 13x75 mm	5 ml	Plain / No Additive	100	1800
Plain / Serum 10 mL - Glass	Ø 16x100mm	10 ml	Plain / No Additive	100	1800
Clot Activator 3 mL - Glass	Ø 13x75 mm	3 ml	Clot Activator	100	1800
Clot Activator 3 mL - Plastic	Ø 13x75 mm	3 ml	Clot Activator	100	1800
Clot Activator 5 mL - Glass	Ø 13x75 mm	5 ml	Clot Activator	100	1800
Clot Activator 5 mL - Glass, for Soft Needle	Ø 13x75 mm	5 ml	Clot Activator	100	1800
Clot Activator 5 mL - Plastic	Ø 13x75 mm	5 ml	Clot Activator	100	1800
Sodium Citrate 1.8 mL - Glass	Ø 13x75 mm	1.8 ml	Sodium Citrate	100	1800
Sodium Citrate 2.7 mL - Glass	Ø 13x75 mm	2.7 ml	Sodium Citrate	100	1800
Sodium Fluoride 3 mL - Glass	Ø 13x75 mm	3 ml	Sodium Fluoride	100	1800
Lithium Heparin 4 mL - Glass	Ø 13x75 mm	4 ml	Heparin Sodium	100	1800
Gel Clot Activator 3 mL - Glass	Ø 13x75 mm	3 ml	Gel & Clot Activator	100	1800
Gel Clot Activator 3 mL - Plastic	Ø 13x75 mm	3 ml	Gel & Clot Activator	100	1800
Gel Clot Activator 5 mL - Glass	Ø 13x75 mm	5 ml	Gel & Clot Activator	100	1800

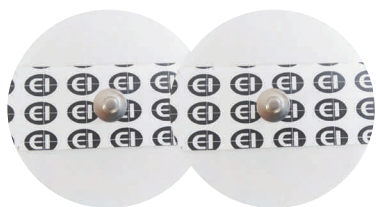

### ENDO ECG Electrode ECG Electrode

ENDO Disposable ECG Electrode, which are used for various ECG test. It uses an Ag/AgCl sensing element and Hydro-gel for adhesion. These are components for sensitive monitoring.



### USG Gel 5L & 250ml Ultrasound Gel

Clear ultrasound gel, no fragrance, no color, acoustically correct for the broad range of frequencies used, no formaldehyde, hypoallergenic, non irritating, bacteriostatic.

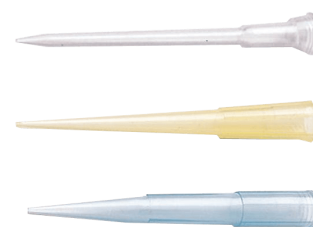

### Micropipette Tip Accessories

Micropipette is a device used to move liquids in small quantities accurately. Compatible : Eppendorf blue, white and yellows tips.





**Bencox ID Cemented & Cementless Stem. Benfix Long Stem Hip System**

Cementless and cemented stem of ID system use same instrumentation. Proximally tapered and grooved stem geometry converts the shear forces to the compressive load. Provides the primary and secondary stability. Protects osteolysis from the wear debris. Adoption of Bencox forte, delta, and metal heads.



**Arthroplasty Revision Knee System**

Maintains Lospa primary knee system's. Stability constrained motion increased AP stability. Modularity, stem extension available augmentation.



**Bencox Cup System Hip System**

Acetabular component is hemisphere shaped, maximizing the peripheral and polar contact at once. Three screw holes are anatomically designed and located for more effective fixation.



**Bencox Bipolar Cup Hip System**

A large array of component allows precise patient matching for optimal patient fit. Outer diameters from 38 to 60mm allow the surgeon to meet the unique challenges posed in a revision and extended situations.



**Lospa Knee System Knee System**

Single axis concept for articular stability with flexion and improving range of motion. Anterior flange shape and dimension for the optimal patella tracking.



**PEEK Cage PLIF, ACIF, TLIF**

The Lospa IS Spinal Fixation System aspire to closely resemble human anatomy while both maximizing surgeon convenience and actively accepting the patient's demand.



**Monoaxial & Polyaxial Pedicle Screw**

Having the low profile minimizes the post surgical projection. Available in standart and guided types to be selected to meet the surgeon's preference.



**Rod, Set Screw & Rod Link Spine**

Rod diameter 6.0mm, length 40-500mm, set screw : as a specially designed screw thread tightens the set screw. Rod link it is simple assembling and strong stable fixation.



### **Cemex System Genta Bone Cement**

Bone cement with Gentamicin, available in two versions : high and low viscosity.



### **Cemex System Genta Fast Bone Cement**

High viscosity, suitable for manual applications where fast application times are required. Also available with Gentamicin.



### **Cemex Genta ID Green Bone Cement**

Bone cement with Gentamicin, ideal in any surgical situation, suitable where fast application times are required.

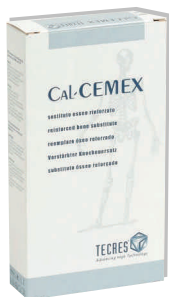

### **Cal-CEMEX Bone Substitute**

Cal CEMEX is the innovative reinforced bone substitute with an hybrid formulation b-TCP + PMMA that facilitate bone growth and assure immediately a very high mechanical resistance.



### **Xtruder & Shakit Application & Mixing Device**

Xtruder is the new Tecres device for application of acrylic resins and bone void fillers prepared with the Shakit mixer. Shakit is the mixing device for easy mixing even of high viscosity resins and bone void fillers.



### **Mendec Spine Bone Cement**

Mendec spine is the user friendly low viscosity spine resin. The preparation process is easy, safe, and does not require an external mixer. Its optimal fluidity and its viscosity allow an easy injection for an extended time.



### **Spacer for Hip, Knee, and Shoulder Preformed Spacer**

Spacer for Hip is resembles a femoral prosthesis, it has a load bearing structure in stainless steel coated with gentamicin bone cement.  
Spacer for Knee resembles a knee prosthesis made in bone cement with gentamicin. It comprises two independent articulating elements.  
Spacer for Shoulder resembles a shoulder prosthesis, it has a load bearing structure in stainless steel coated with gentamicin bone cement.

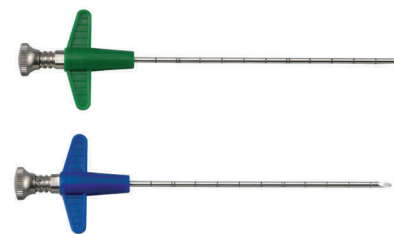

### **Bone Injection Needle Bone Injection Needle**

Luer lock connection system, shock resistant metal head, ergonomic handle in radiotransparent plastic or steel, needle direction maker. Available in 2 type, diamond tip and beveled tip.

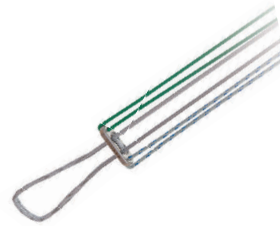
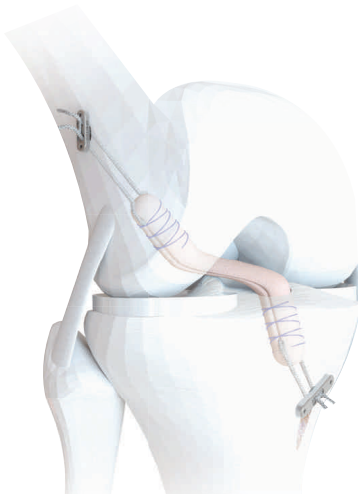

### ***Pullup Endobutton ACL PCL Reconstruction***

PULLUP implants are made of titanium alloy and premounted sutures, available in two designs depending on the tunnel diameter. Reproducible, reliable, simple.

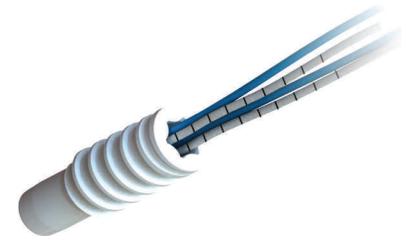

### ***Pre-loaded Absorbable Fixit***

Easy insertion, optimal tension maintained on the suture. Available from size 4.5mm. Absorbable threaded anchor.

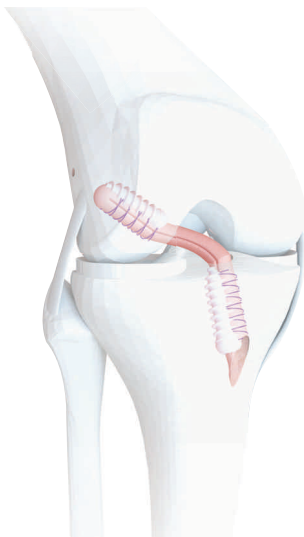

### ***Ligafix Interference Screw ACL PCL Reconstruction***

Bioabsorbable, made of Duosorb material, the implants are absorbed progressively & do not compromise. Osteoconduction, the high level of TCP promotes bone ingrowth.



### ***Knotless Absorbable Fixit Knotless***

Fixit Knotless reusable screwdriver. Fixation system : easy, quick, reproducible, accomodates up to 4 suture strands.

## **CALEB**

INNOVATIVE MEDICAL DEVICE



### ***Pulse Lavage Single Use Pulse Lavage***

Clean bone bed, improve bone cement interface. High pressure pulse lavage. Effective cleaning for optimal micro interlock. Reduced risk of fat embolism.

## **GOMINA**

SWISS QUALITY



### ***Gomina Saw Blade Saw Blade***

Saw blade for oscialting saw (used for ENDO Power Tool, Sagittal Saw System).

## **Knetic**



### ***KMC Balloon Kyphoplasty Kyphoplasty***

Unipedicular approach, less operation time. Navigationally pass the midline of vertebral body. Create an arc shaped void with less damage to surrounding cancellous bone.

## Titanium, Mini Fragment Trauma Implant

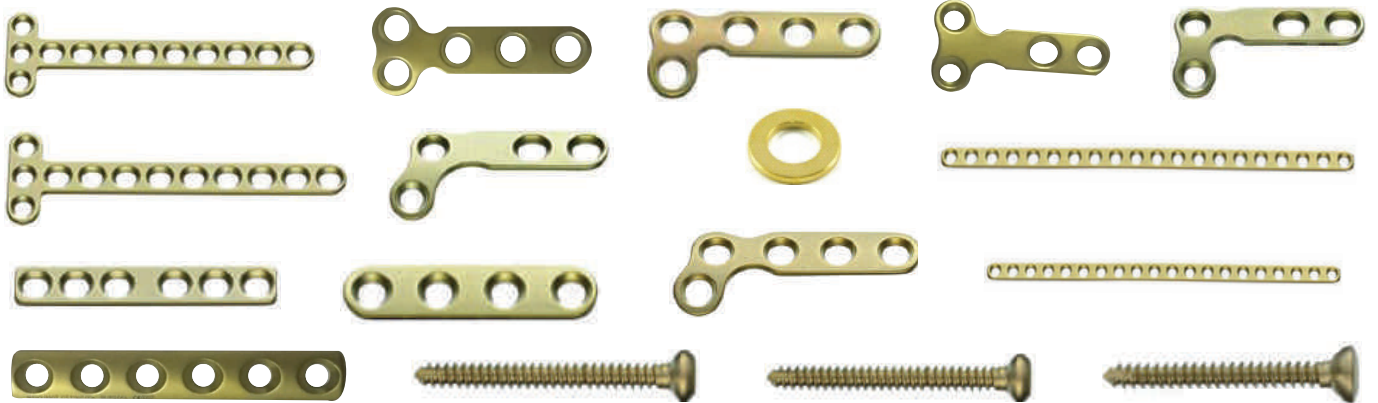

## Titanium, Small Fragment Trauma Implant

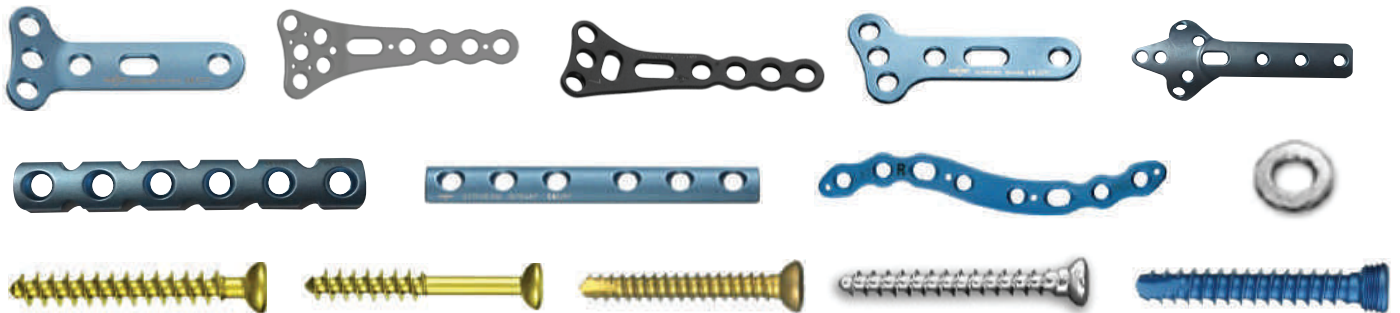

## Titanium, Large Fragment Trauma Implant



## Titanium, Shoulder Fragment Trauma Implant



## Titanium, Foot Implant Trauma Implant

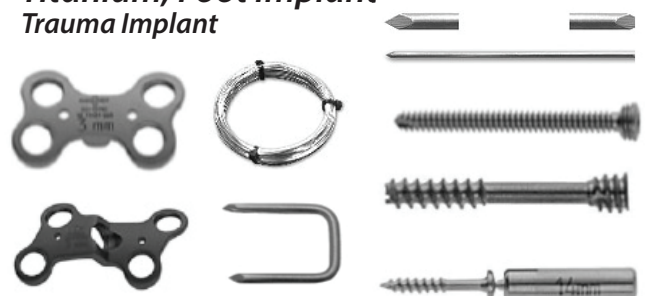



*Interlocking Nail*

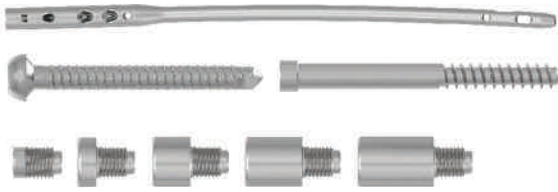

*KTO Femoral Intramedullary Nail*



*KTO Tibial Intramedullary Nail*



*KTO Humerus Intramedullary Nail*

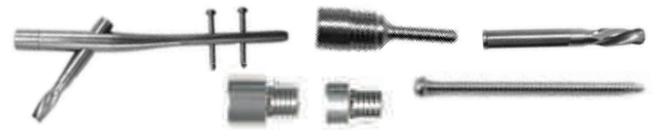

*KTO PFNA Gamma Nail*

*Stainless Steel, Locking Fragment  
Trauma Implant*



*Stainless Steel, Non Locking Fragment  
Trauma Implant*

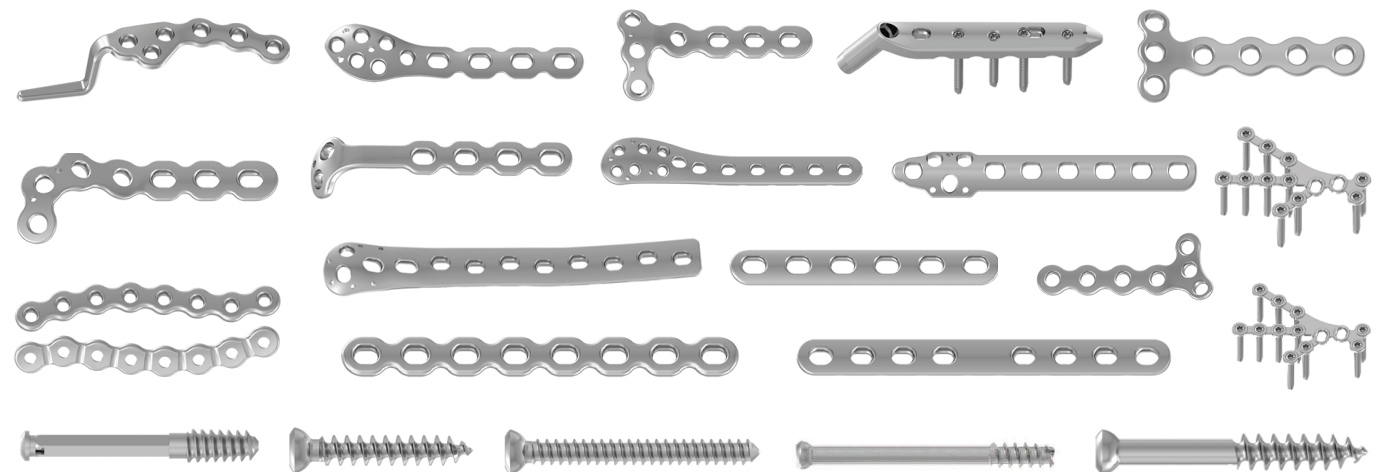

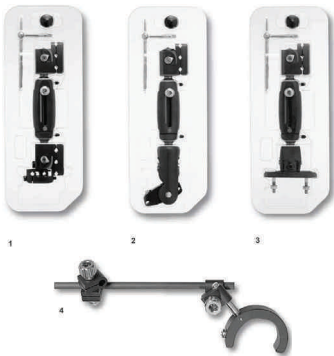

**Peek Fixator**

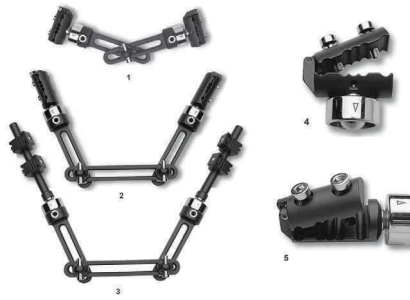

**Pelvic Fixator**

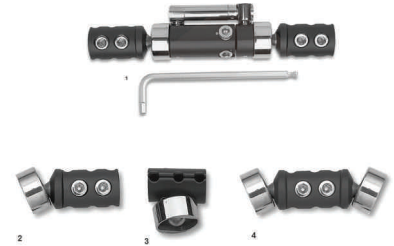

**Paediatric Fixator**

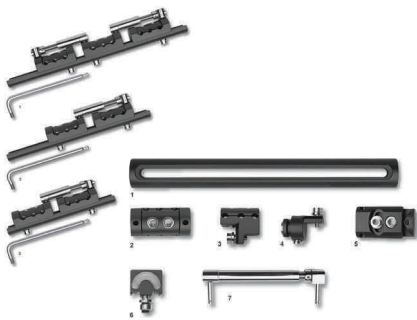

**Paediatric Limb Reconstruction System**

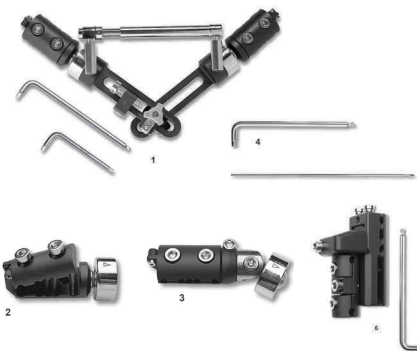

**Elbow Fixator**

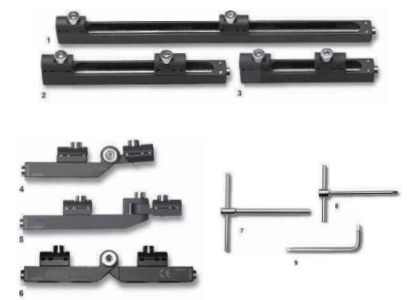

**Minirail Fixator**



**Rod to Pin**

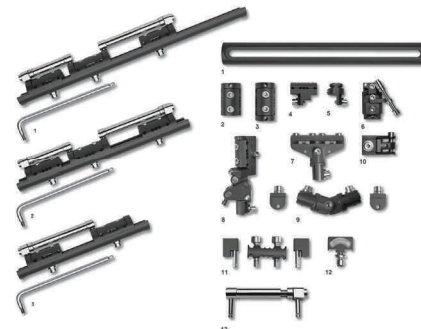

**Adult Limb Reconstruction System**



**Wrist Fixator**



**Transknee Fixator System**

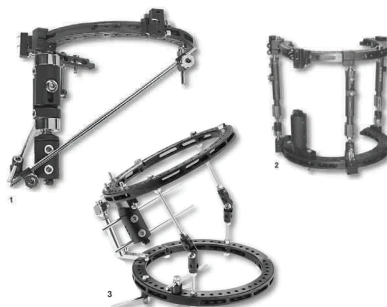

**Hybrid Fixator System**

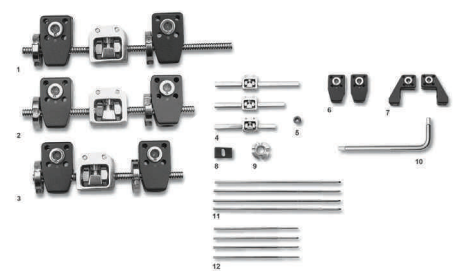

**Mini Fixator**



## ENDO Medical Recording Chart Paper

- ECG/EKG Paper
- Treadmill Paper
- CTG/NST Paper
- Defibrillator Paper
- Chemistry Analyzer Paper
- Audiometer Paper
- Patient Monitor Paper
- Spirometer Paper
- Hematology Analyzer Paper
- Auto Refractometer Paper

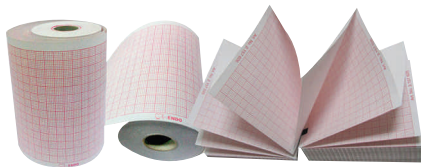

ECG Paper

## ENDO Medical Recording Chart Paper

- Dark and vivid print out
- Medical Grade Material
- Accurate precision
- Consistent quality and supply reliability, for more than 100 Paper types for use on most major machine brands.



Treadmill Paper



CTG / NST Paper



Thermal Paper



## USG Video Printer Paper



- Compatible USG Paper for Sony UPP-110HG
- Long Lasting Image Durability for High Storage Stability
- Precise, High Resolution Image Reproduction
- Trouble-free Printing & Long-Term Use of Printer





## **PT. ENDO Indonesia**

Jl. Raya Menganti No. 14, Kedurus - Surabaya 60223

---

 +62-31-767 3636  [info@endo.id](mailto:info@endo.id)

 +62-31-767 3737  <https://endo.id>

 Toll Free : 0800-177-ENDO (3636)