

Bfix[®]
www.aikesh.com

Bfix[®]
www.aikesh.com

Aike Medical Instrument CO.,Ltd

Room B321, South City Road 1128, Jiading District, Shanghai, 201800
Tel/Fax: 021-56653090 56653091
E-mail: manager@aikesh.com
www.aikesh.com



External Fixation System

Aike Medical Instrument CO.,Ltd

Mini Fixator-Universal



code	specification	
D501	long	85mm
D502	middle	75mm
D503	short	65mm

Schanz Pin		
Diameter (mm)	Specification (mm) Screw length / thread length	code
2.0	100/15	SL02015100

Indications:
Phalange&Metacarpal fractures
-Distal ulna fractures

Mini Fixator-Horizontal Axis

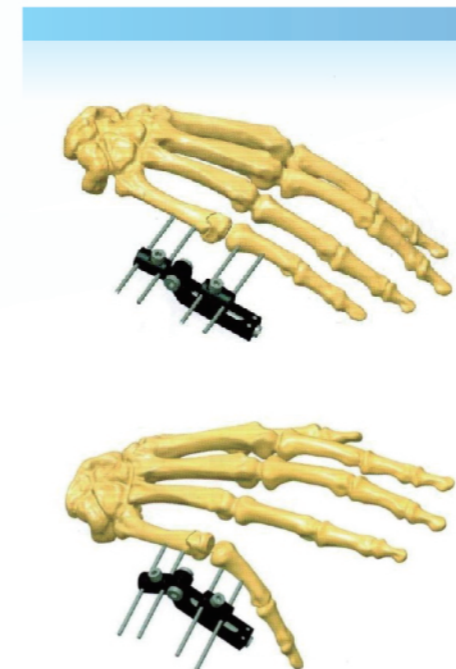

code		
D507		

Schanz Pin		
Diameter (mm)	Specification (mm) Screw length / thread length	code
2.0	100/15	SL02015100

Indications:
Fractures around the metacarpal joint.
Allows the lengthening of the proximal phalange,distracts the articulation to maximise the early mobilization.

Clamps in L-type



code	specification	
D513	long	85mm
D514	middle	75mm
D515	short	65mm

Schanz Pin		
Diameter (mm)	Specification (mm) Screw length / thread length	code
2.0	100/15	SL02015100

Indications:
For finger,metacarpal,distal ulna fractures

Mini Fixator-Vertical Axis

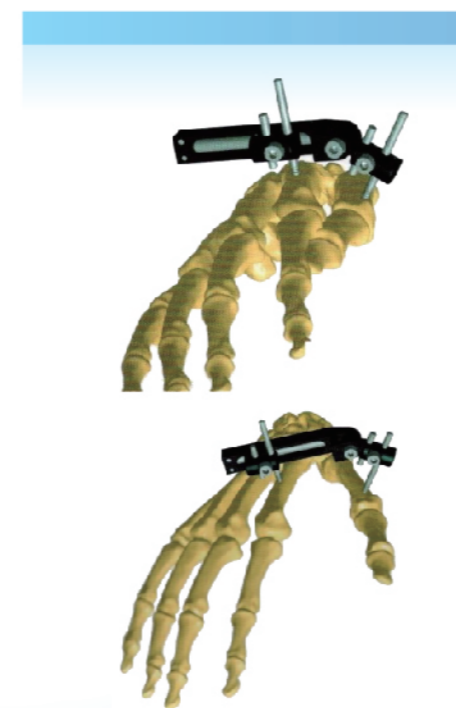

code		
D509		

Schanz Pin		
Diameter (mm)	Specification (mm) Screw length / thread length	code
2.0	100/15	SL02015100

Indications:
Soft tissue correction

Mini Fixator-Horizontal Axis II



code		
D511		
Schanz Pin		
Diameter (mm)	Specification (mm) Screw length / thread length	code
2.0	100/15	SL02015100

Wrist Fixator

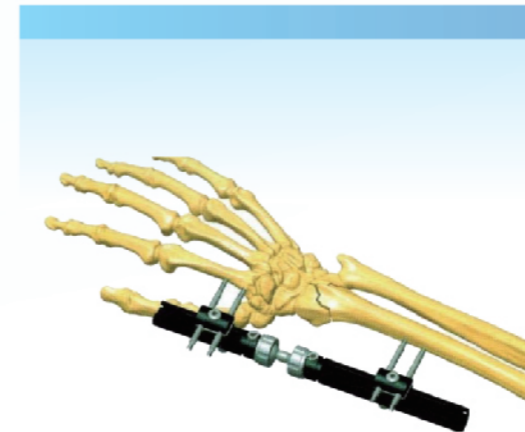

code	specification
D401	Universal
D402	Compression –Distraction
D125	Radiolucent
Schanz Pin	
Diameter (mm)	Specification (mm) Screw length / thread length code
4.0/3.0	70/25 PLT402070
4.0/3.0	80/35 PLT403580

Indications:
–Fractures around the wrist joint
–Combined–fracture of ulna&radius
Note:To insert the schanz pin,a 2.5mm drill bit is necessary.

Minirail Fixator

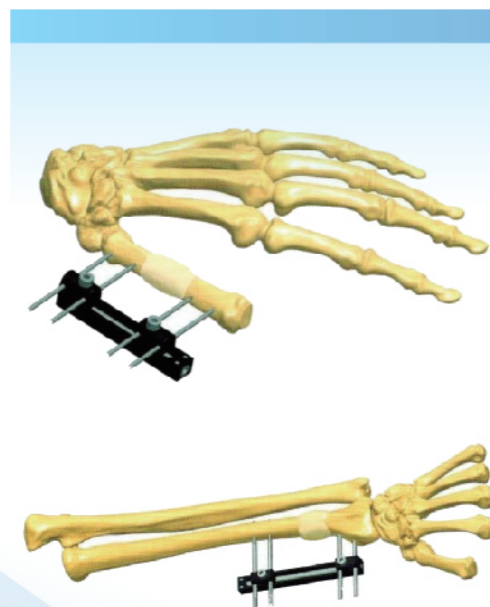

code	specification
D504	long 170mm
D505	middle 95mm
D506	short 70mm
D517	T–type,middle 95mm
D518	T–type,short 70mm
Schanz Pin	
Diameter (mm)	Specification (mm) Screw length / thread length code
2.0	100/15 SL02015100

Indication:
Allows lengthening of the metacarpal &radius–ulna part
Insert the screws, perform an osteotomy before commencing distraction.

Wrist Fixator in L-type

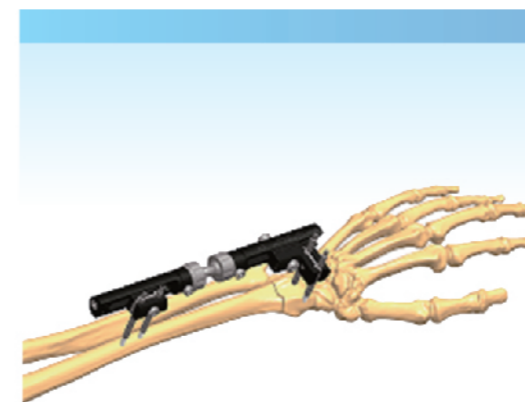

code	specification
D407	Normal
D408	Compression –Distraction
Schanz Pin	
Diameter (mm)	Specification (mm) Screw length / thread length code
4.0/3.0	70/25 PLT402070
4.0/3.0	80/35 PLT403580

Indications:
–Fracture around the wrist joint.
–Combined–fracture of ulna&radius
Note:
–Once require metaphyseal osteotomy or fractures closed to the distal part,use the L–type Clamp(D4001)
–To insert the Schanz pin,a 2.5mm drill bit is necessary.

Elbow Fixator

code			
D305			
Schanz Pin			
Diameter (mm)	Specification (mm) Screw length / thread length	code	
6.0/5.0	90/30	PLT603090 (5060)	
6.0/5.0	100/30	PLT6030100 (5060)	
6.0/5.0	100/40	PLT6040100 (5060)	
6.0/5.0	110/30	PLT6030110 (5060)	
6.0/5.0	120/40	PLT6040120 (5060)	
6.0/5.0	130/40	PLT6040130 (5060)	
6.0/5.0	150/30	PLT6030150 (5060)	
6.0/5.0	150/40	PLT6040150 (5060)	
6.0/4.5	90/30	PLT603090 (3545)	
6.0/4.5	100/30	PLT6030100 (3545)	
6.0/4.5	100/40	PLT6040100 (3545)	
6.0/4.5	110/40	PLT6040110 (3545)	
6.0/4.5	120/30	PLT6030120 (3545)	
6.0/4.5	120/40	PLT6040120 (3545)	

Indications:
Fractures around the elbow joints. Use a 6.0/5.0mm Schanz pin for humerus shaft with drill bit 4.8mm
Use a 6.0/4.5mm Schanz pin for ulna shaft with drill bit 3.2mm

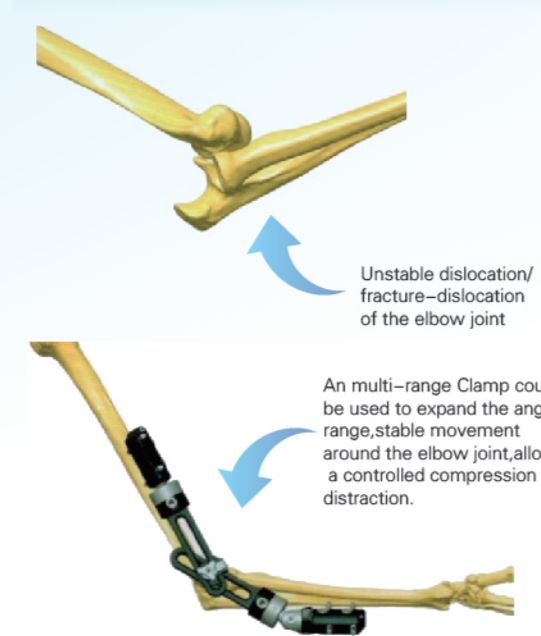



- 1: Stiffness of the elbow joint.
- 2: Insert the screws and fixator, distract the joint to perform a controlled movement.
- 3: Early flexion and extension after surgery.

Micro-Movement Fixator-Lower limbs

code			specification
D101	long	0-80mm	
D102	middle	0-40mm	
D103	short	0-20mm	

Schanz Pin		
Diameter (mm)	Specification (mm) Screw length / thread length	code
2.0	100/15	SL02015100
6.0/5.0	100/30	PLT6030100 (5060)
6.0/5.0	100/40	PLT6040100 (5060)
6.0/5.0	110/30	PLT6030110 (5060)
6.0/5.0	120/40	PLT6040120 (5060)
6.0/5.0	130/40	PLT6040130 (5060)
6.0/5.0	130/50	PLT6050130 (5060)
6.0/5.0	150/30	PLT6030150 (5060)
6.0/5.0	150/40	PLT6040150 (5060)
6.0/5.0	150/50	PLT6050150 (5060)
6.0/5.0	170/40	PLT6040170 (5060)

Indications
Normal fractures of the lower limbs
Micro-movement facility
Use a drill bit of 4.8mm



Micro-Movement Fixator T-type

code			specification
D105	long	0-80mm	
D106	middle	0-40mm	
D107	short	0-20mm	
D123	Radiolucent		

Schanz Pin		
Diameter (mm)	Specification (mm) Screw length / thread length	code
6.0/5.0	100/30	PLT6030100 (5060)
6.0/5.0	100/40	PLT6040100 (5060)
6.0/5.0	110/30	PLT6030110 (5060)
6.0/5.0	120/40	PLT6040120 (5060)
6.0/5.0	130/40	PLT6040130 (5060)
6.0/5.0	130/50	PLT6050130 (5060)
6.0/5.0	150/30	PLT6030150 (5060)
6.0/5.0	150/40	PLT6040150 (5060)
6.0/5.0	150/50	PLT6050150 (5060)
6.0/5.0	170/40	PLT6040170 (5060)

Indications
Normal fractures of the lower limbs
Micro-movement facility
Use a drill bit of 4.8mm

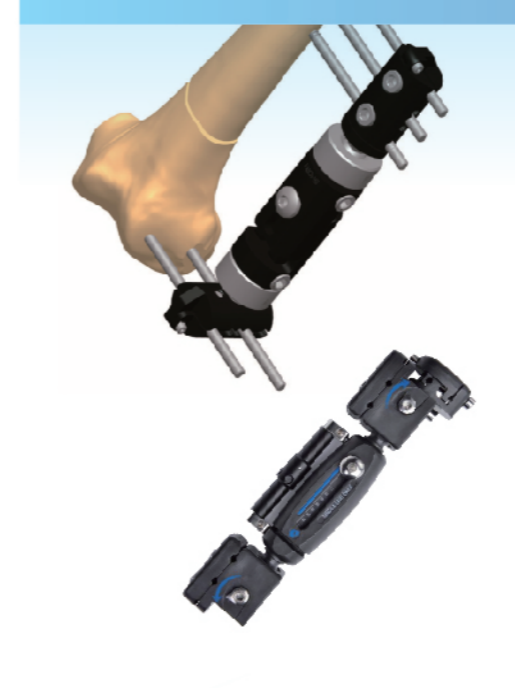

Micro-Movement Fixator T-type II



code	specification
D109	0-80mm
D110	0-40mm
D111	0-20mm

Schanz Pin		
Diameter (mm)	Specification (mm) Screw length / thread length	code
6.0/5.0	100/30	PLT6030100 (5060)
6.0/5.0	100/40	PLT6040100 (5060)
6.0/5.0	110/30	PLT6030110 (5060)
6.0/5.0	120/40	PLT6040120 (5060)
6.0/5.0	130/40	PLT6040130 (5060)
6.0/5.0	130/50	PLT6050130 (5060)
6.0/5.0	150/30	PLT6030150 (5060)
6.0/5.0	150/40	PLT6040150 (5060)
6.0/5.0	150/50	PLT6050150 (5060)
6.0/5.0	170/40	PLT6040170 (5060)

Indications:
Fractures close to the joint. Use a drill bit of 4.8mm

Pelvis Fixator

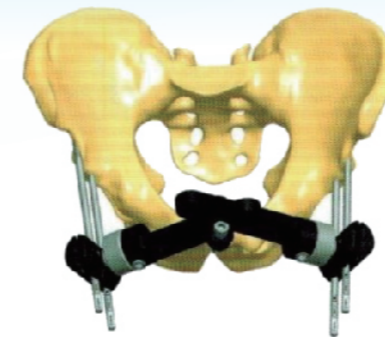

code	specification
D301	Two Links.
D302	Three Links
D307	Pelvis fixator combined with rod-pin system.

Schanz Pin		
Diameter (mm)	Specification (mm) Screw length / thread length	code
6.0/5.0	120/50	ZLO6050120 (5060)
6.0/5.0	130/50	ZLO6050130 (5060)
6.0/5.0	140/50	ZLO6050140 (5060)
6.0/5.0	150/40	ZLO6040150 (5060)
6.0/5.0	150/50	ZLO6050150 (5060)
6.0/5.0	200/50	ZLO6050200 (5060)

Indications:
Fracture of dislocation of the pelvis.
Open book injury
Use a 4.8mm drill bit together with Schanz pin auto-tapping and auto-drilling

Pediatric Fixator



code	specification
D104	Standard
D108	Carbon Type.

Schanz Pin		
Diameter (mm)	Specification (mm) Screw length / thread length	code
6.0/4.5	90/30	PLT603090 (3545)
6.0/4.5	100/30	PLT6030100 (3545)
6.0/4.5	100/40	PLT6040100 (3545)
6.0/4.5	110/40	PLT6040110 (3545)
6.0/4.5	120/30	PLT6030120 (3545)
6.0/4.5	120/40	PLT6040120 (3545)

Indications:
-Fractures pediatrics
-Fractures of humerus (adult)
Use a drill bit of 3.2mm

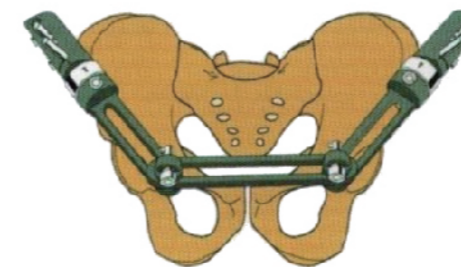

Pertrochanteric Fixator

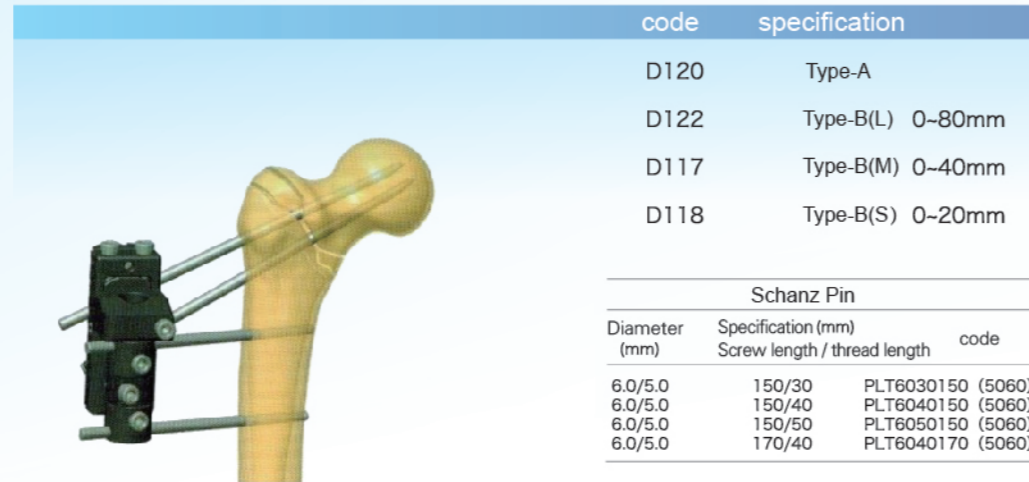

Type-A

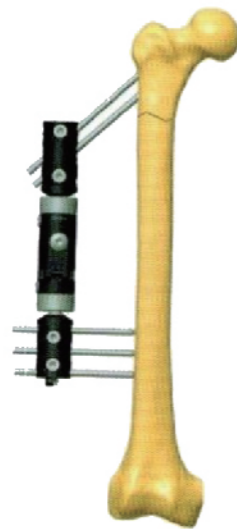

Type-B

code	specification
D120	Type-A
D122	Type-B(L) 0~80mm
D117	Type-B(M) 0~40mm
D118	Type-B(S) 0~20mm

Schanz Pin		
Diameter (mm)	Specification (mm) Screw length / thread length	code
6.0/5.0	150/30	PLT6030150 (5060)
6.0/5.0	150/40	PLT6040150 (5060)
6.0/5.0	150/50	PLT6050150 (5060)
6.0/5.0	170/40	PLT6040170 (5060)

Schanz Pin		
Diameter (mm)	Specification (mm) Screw length / thread length	code
6.0/5.0	150/40	ZL06040150 (5060)
6.0/5.0	150/50	ZL06050150 (5060)
6.0/5.0	200/50	ZL06050200 (5060)
6.0/5.0	220/40	ZL06040220 (5060)
6.0/5.0	220/60	ZL06060220 (5060)

Indications:
Fractures of trochanteric and subtrochanteric fractures.

Micro-Movement Fixator with T-Clamps (Big)



code	specification
D112	long 0~80mm
D113	middle 0~40mm
D114	short 0~20mm

Schanz Pin		
Diameter (mm)	Specification (mm) Screw length / thread length	code
6.0/5.0	120/40	PLT6040120 (5060)
6.0/5.0	130/40	PLT6040130 (5060)
6.0/5.0	130/50	PLT6050130 (5060)
6.0/5.0	150/30	PLT6030150 (5060)
6.0/5.0	150/40	PLT6040150 (5060)
6.0/5.0	150/50	PLT6050150 (5060)
6.0/5.0	170/40	PLT6040170 (5060)

Schanz Pin autotapping and autodrilling		
Diameter (mm)	Specification (mm) Screw length / thread length	code
6.0/5.0	150/40	ZL06040150 (5060)
6.0/5.0	150/50	ZL06050150 (5060)
6.0/5.0	200/50	ZL06050200 (5060)
6.0/5.0	220/40	ZL06040220 (5060)
6.0/5.0	220/60	ZL06060220 (5060)

Indications:
Fracture closed to the knee joint. Joint fusion of the hip.
Drill bit: 4.8mm

Micro-Movement Fixator-Ankle.



code	specification
D121	long 0~80mm
D115	middle 0~40mm
D116	short 0~20mm
D126	Radiolucent(L) 0~80mm
D127	Radiolucent(M) 0~40mm
D128	Radiolucent(S) 0~20mm

Schanz Pin		
Diameter (mm)	Specification (mm) Screw length / thread length	code
6.0/5.0	100/30	PLT6030100 (5060)
6.0/5.0	100/40	PLT6040100 (5060)
6.0/5.0	110/30	PLT6030110 (5060)
6.0/5.0	120/40	PLT6040120 (5060)
6.0/5.0	130/40	PLT6040130 (5060)
6.0/5.0	130/50	PLT6050130 (5060)
6.0/5.0	150/30	PLT6030150 (5060)
6.0/5.0	150/40	PLT6040150 (5060)

Indication:
Fractures close to the Ankle joint. Use a 4.8 mm drill bit.

Limbs Reconstruction Fixator

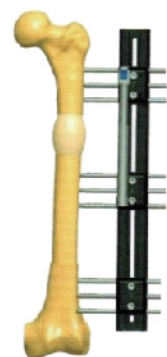
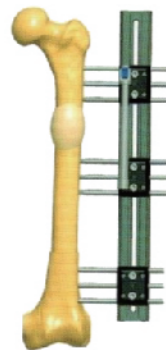

code	specification
D201	long 400mm
D202	middle 300mm
D203	short 200mm
D204	Paediatric-long 250mm
D205	Paediatric-middle 200mm
D206	Paediatric-short 150mm

Schanz Pin

Diameter (mm)	Specification (mm) Screw length / thread length	code
6.0/5.0	120/40	PLT6040120 (5060)
6.0/5.0	130/40	PLT6040130 (5060)
6.0/5.0	130/50	PLT6050130 (5060)
6.0/5.0	150/30	PLT6030150 (5060)
6.0/5.0	150/40	PLT6040150 (5060)
6.0/5.0	150/50	PLT6050150 (5060)
6.0/5.0	170/40	PLT6040170 (5060)

Pediatric Schanz Screws

Diameter (mm)	Specification (mm) Screw length / thread length	code
6.0/4.5	90/30	PLT603090 (3545)
6.0/4.5	100/30	PLT6030100 (3545)
6.0/4.5	100/40	PLT6040100 (3545)
6.0/4.5	110/40	PLT6040110 (3545)
6.0/4.5	120/30	PLT6030120 (3545)
6.0/4.5	120/40	PLT6040120 (3545)

Indications
-Bone non-union
-Bone lengthening
-Bone transport
-Angular deformities

Hybrid Fixator

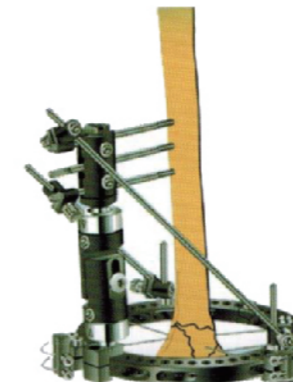

code	specification
H805	175mm long
H806	175mm middle
H807	175mm short
H808	190mm long
H809	190mm middle
H810	190mm short
H811	220mm long
H812	220mm middle
H813	220mm short

Schanz Pin

Diameter (mm)	Specification (mm) Screw length / thread length	code
6.0/5.0	120/40	PLT6040120 (5060)
6.0/5.0	130/40	PLT6040130 (5060)
6.0/5.0	130/50	PLT6050130 (5060)
6.0/5.0	150/30	PLT6030150 (5060)
6.0/5.0	150/40	PLT6040150 (5060)
6.0/5.0	150/50	PLT6050150 (5060)
6.0/5.0	170/40	PLT6040170 (5060)

Indications:
Fracture of tibial plateau Fracture of distal tibia
Use a Olive K-wire 3-4 pieces, drill bit 4.8mm.

K-Wire

Diameter (mm)	Specification (mm) Screw length / thread length	code
2.0	350	GM020 ₃₅₀ (media Type)
2.0	350	GN020 ₃₅₀ (lateral Type)
2.0	350	SH020 ₃₅₀

Indications:
Fracture of knee-joint
Use a drill bit 4.8mm, Olive K-wire can be used if necessary.

Double Ring Fixator



code	specification(diameter)
H701	150mm
H702	175mm
H703	190mm
H704	220mm

Indications:
Fracture of knee-joint
Use a drill bit 4.8mm, Olive K-wire can be used if necessary.

Ankle deformity correction Fixator

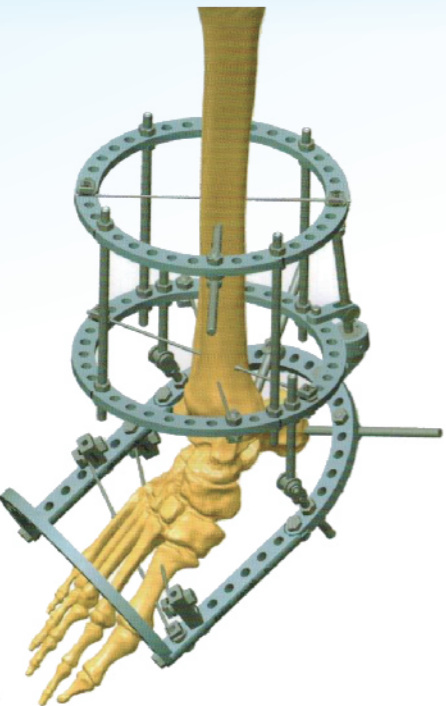

code	specification
H710	150mm
H712	170mm
H714	200mm

Schanz Pin		
Diameter (mm)	Specification (mm) Screw length / thread length	code
6.0/5.0	120/40	PLT6040120 (5060)
6.0/5.0	130/40	PLT6040130 (5060)
6.0/5.0	130/50	PLT6050130 (5060)
6.0/5.0	150/30	PLT6030150 (5060)
6.0/5.0	150/40	PLT6040150 (5060)
6.0/5.0	150/50	PLT6050150 (5060)
6.0/5.0	170/40	PLT6040170 (5060)

indications:
Fractures around the metatarsal joint. Allows the lengthening of the proximal phalange, distracts the articulation to maximise the early mobilization.

K-Wire		
Diameter (mm)	Specification (mm) Screw length / thread length	code
2.0	350	GM020350 (media Type)
2.0	350	GN020350 (lateral Type)
2.0	350	SH020350

indications:
Deformity correction of talipes equinus, talipes varus and valgus. Use a 4.8mm drill bit, Olive K-wire could be used if necessary.



Universal Ring Fixator for Deformity Correction

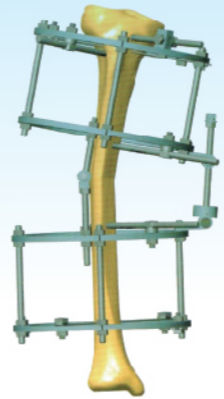

code	specification
H717	120mm
H718	130mm
H719	140mm
H720	150mm
H721	160mm
H722	170mm
H723	180mm
H724	200mm
H725	220mm
H726	240mm

indications:
Correction of deformity of lower limbs.
Use a 4.8mm drill bit. Use a 4.8mm drill bit, Olive K-wire could be used if necessary.

Ring Fixator for Fractures

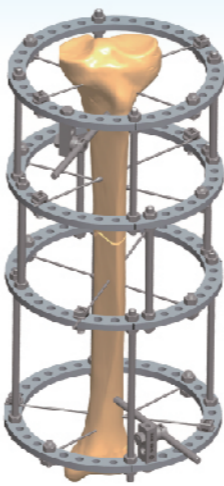

code	specification
H729	120mm
H730	130mm
H731	140mm
H732	150mm
H733	160mm
H734	170mm
H735	180mm
H736	200mm
H737	220mm
H738	240mm

Schanz Pin		
Diameter (mm)	Specification (mm) Screw length / thread length	code
6.0/5.0	90/30	PLT603090 (5060)
6.0/5.0	100/30	PLT6030100 (5060)
6.0/5.0	100/40	PLT6040100 (5060)
6.0/5.0	110/30	PLT6030110 (5060)
6.0/5.0	120/40	PLT6040120 (5060)
6.0/5.0	130/40	PLT6040130 (5060)
6.0/5.0	130/50	PLT6050130 (5060)
6.0/5.0	150/30	PLT6030150 (5060)
6.0/5.0	150/40	PLT6040150 (5060)
6.0/5.0	150/50	PLT6050150 (5060)
6.0/5.0	170/40	PLT6040170 (5060)
4.0/3.0	70/20	PLT402070 (2530)
4.0/3.0	80/35	PLT403580 (2530)

K-Wire		
Diameter (mm)	Specification (mm) Screw length / thread length	code
2.0	350	GM020350 (media Type)
2.0	350	GN020350 (lateral Type)
2.0	350	SH020350

indications:
Fractures relative to the articular surface/
Use a 4.8mm drill bit. Use a 4.8mm drill bit, Olive K-wire could be used if necessary.

Instruments

	Code	Description	specification
	G11102	Screw Guide	60mm
	G11101	Screw Guide	80mm
	G11103	Screw Guide	100mm
	G11124	Screw Guide	160mm
	G11104	Drill Guide	4.8mm
	G11106	Drill Guide	3.2mm
	G13531	Drill Guide	2.0mm
	G13520	Screw Guide for wrist fixator	
	G11004	Tapered Troca	195mm
	G11129	Tapered Troca	240mm
	G13540	Straight Trocar for wrist	
	G1100701	Drill Bit	4.8mm
	G1100301	Drill Bit	3.2mm
	G1355101	Drill Bit	2.0mm
	G11000	T-Wrench	6.0mm
	G21000	T-Wrench	4.0mm
	G18001	K-wire tensioner	
	G10017	Allen Key	6.0mm
	G10013	Allen Key	4.0mm
	G10012	Allen Key	3.0mm
	G18002	Guid for K-wire	





Rod to Pin External fixation System

	Code	Mode	specification	Material
	D605Cr	4 Screws with 1 rod	9mm long	SS
	D607Cr	4 Screws with 1 rod	6mm long	SS
	D608Cr	4 Screws with 1 rod	6mm middle	SS
	D601AL	4 Screws with 1 rod	14mm long	Aluminum
	D602AL	4 Screws with 1 rod	14mm middle	Aluminum
	D603AL	4 Screws with 1 rod	12mm long	Aluminum
	D604AL	4 Screws with 1 rod	12mm middle	Aluminum
	D605AL	4 Screws with 1 rod	9mm long	Aluminum
	D606AL	4 Screws with 1 rod	9mm middle	Aluminum
	D607AL	4 Screws with 1 rod	6mm long	Aluminum
	D608AL	4 Screws with 1 rod	6mm middle	Aluminum
	D601Ts	4 Screws with 1 rod	14mm long	Carbon
	D602Ts	4 Screws with 1 rod	14mm middle	Carbon
	D603Ts	4 Screws with 1 rod	12mm long	Carbon
	D604Ts	4 Screws with 1 rod	12mm middle	Carbon
	D605Ts	4 Screws with 1 rod	9mm long	Carbon
	D606Ts	4 Screws with 1 rod	9mm middle	Carbon
	D607Ts	4 Screws with 1 rod	6mm long	Carbon
	D608Ts	4 Screws with 1 rod	6mm middle	Carbon

4 Pin 3 Rod

fast and easy assembly.
Stable temporary and definitive fixation, cross the joint.
Use self-tapping and self-drilling screws. No need pre-drilled.



Rod to Pin External fixation System

	Code	Mode	specification	Material
	D618Cr	4 screws with 3 rods	6mm long	SS
	D619Cr	4 screws with 3 rods	6mm middle	SS
	D620Cr	4 screws with 3 rods	6mm short	SS
	D609AL	4 screws with 3 rods	14mm long	Aluminum
	D610AL	4 screws with 3 rods	14mm middle	Aluminum
	D611AL	4 screws with 3 rods	14mm short	Aluminum
	D612AL	4 screws with 3 rods	12mm long	Aluminum
	D613AL	4 screws with 3 rods	12mm middle	Aluminum
	D614AL	4 screws with 3 rods	12mm short	Aluminum
	D615AL	4 screws with 3 rods	9mm long	Aluminum
D616AL	4 screws with 3 rods	9mm middle	Aluminum	
D617AL	4 screws with 3 rods	9mm short	Aluminum	
D618AL	4 screws with 3 rods	6mm long	Aluminum	
D619AL	4 screws with 3 rods	6mm middle	Aluminum	
D620AL	4 screws with 3 rods	6mm short	Aluminum	
	D609Ts	4 screws with 3 rods	14mm long	Carbon
	D610Ts	4 screws with 3 rods	14mm middle	Carbon
	D611Ts	4 screws with 3 rods	14mm short	Carbon
	D612Ts	4 screws with 3 rods	12mm long	Carbon
	D613Ts	4 screws with 3 rods	12mm middle	Carbon
	D614Ts	4 screws with 3 rods	12mm short	Carbon
	D615Ts	4 screws with 3 rods	9mm long	Carbon
	D616Ts	4 screws with 3 rods	9mm middle	Carbon
	D617Ts	4 screws with 3 rods	9mm short	Carbon
	D618Ts	4 screws with 3 rods	6mm long	Carbon
D619Ts	4 screws with 3 rods	6mm middle	Carbon	
D620Ts	4 screws with 3 rods	6mm short	Carbon	
D630Cr	4 screws with 2 rods	6mm long	SS	
D631Cr	4 screws with 2 rods	6mm middle	SS	
D632Cr	4 screws with 2 rods	6mm short	SS	
	D621AL	4 screws with 2 rods	14mm long	Aluminum
	D622AL	4 screws with 2 rods	14mm middle	Aluminum
	D623AL	4 screws with 2 rods	14mm short	Aluminum
	D624AL	4 screws with 2 rods	12mm long	Aluminum
	D625AL	4 screws with 2 rods	12mm middle	Aluminum
	D626AL	4 screws with 2 rods	12mm short	Aluminum
	D627AL	4 screws with 2 rods	9mm long	Aluminum
	D628AL	4 screws with 2 rods	9mm middle	Aluminum
	D629AL	4 screws with 2 rods	9mm short	Aluminum
	D630AL	4 screws with 2 rods	6mm long	Aluminum
D631AL	4 screws with 2 rods	6mm middle	Aluminum	
D632AL	4 screws with 2 rods	6mm short	Aluminum	
	D621Ts	4 screws with 2 rods	14mm long	Carbon
	D622Ts	4 screws with 2 rods	14mm middle	Carbon
	D623Ts	4 screws with 2 rods	14mm short	Carbon
	D624Ts	4 screws with 2 rods	12mm long	Carbon
	D625Ts	4 screws with 2 rods	12mm middle	Carbon
	D626Ts	4 screws with 2 rods	12mm short	Carbon
	D627Ts	4 screws with 2 rods	9mm long	Carbon
	D628Ts	4 screws with 2 rods	9mm middle	Carbon
	D629Ts	4 screws with 2 rods	9mm short	Carbon
	D630Ts	4 screws with 2 rods	6mm long	Carbon
D631Ts	4 screws with 2 rods	6mm middle	Carbon	
D632Ts	4 screws with 2 rods	6mm short	Carbon	

4 Pin 3 Rod

4 Pin 2 Rod

Rod to Pin External fixation System

	Code	Mode	specification	Material
	D642Cr	2 screws with 1 rod	6mm long	SS
	D643Cr	2 screws with 1 rod	6mm middle	SS
	D644Cr	2 screws with 1 rod	6mm short	SS
	D633AL	2 screws with 1 rod	14mm long	Aluminum
	D634AL	2 screws with 1 rod	14mm middle	Aluminum
	D635AL	2 screws with 1 rod	14mm short	Aluminum
	D636AL	2 screws with 1 rod	12mm long	Aluminum
	D637AL	2 screws with 1 rod	12mm middle	Aluminum
	D638AL	2 screws with 1 rod	12mm short	Aluminum
	D639AL	2 screws with 1 rod	9mm long	Aluminum
	D640AL	2 screws with 1 rod	9mm middle	Aluminum
	D641AL	2 screws with 1 rod	9mm short	Aluminum
	D642AL	2 screws with 1 rod	6mm long	Aluminum
D643AL	2 screws with 1 rod	6mm middle	Aluminum	
D644AL	2 screws with 1 rod	6mm short	Aluminum	
	D633Ts	2 screws with 1 rod	14mm long	Carbon
	D634Ts	2 screws with 1 rod	14mm middle	Carbon
	D635Ts	2 screws with 1 rod	14mm short	Carbon
	D636Ts	2 screws with 1 rod	12mm long	Carbon
	D637Ts	2 screws with 1 rod	12mm middle	Carbon
	D638Ts	2 screws with 1 rod	12mm short	Carbon
	D639Ts	2 screws with 1 rod	9mm long	Carbon
	D640Ts	2 screws with 1 rod	9mm middle	Carbon
	D641Ts	2 screws with 1 rod	9mm short	Carbon
	D642Ts	2 screws with 1 rod	6mm long	Carbon
D643Ts	2 screws with 1 rod	6mm middle	Carbon	
D644Ts	2 screws with 1 rod	6mm short	Carbon	

2 Pin 1 Rod

Schanz Pin		
Diameter (mm)	Specification (mm) Screw length / thread length	code
6.0/5.0	120/50	ZL06050120 (5060)
6.0/5.0	130/50	ZL06050130 (5060)
6.0/5.0	140/50	ZL06050140 (5060)
6.0/5.0	150/40	ZL06040150 (5060)
6.0/5.0	150/50	ZL06050150 (5060)
6.0/5.0	200/50	ZL06050200 (5060)
6.0/5.0	220/40	ZL06040220 (5060)
6.0/5.0	220/60	ZL06060220 (5060)
4.0/3.0	70/30	ZL0403070 (3033)
4.0/3.0	100/30	ZL04030100 (3033)
4.0/3.0	80/35	ZL0403580 (2530)
3.0/2.5	50/18	ZL0301850 (2530)
3.0/2.5	70/15	ZL0301570 (2530)
3.0/2.5	70/20	ZL0302070 (2530)
3.0/2.5	70/30	ZL0303070 (2530)
3.0/2.5	100/30	ZL03030100 (2530)

Self-tapping & Self-drilling Schanz Screw

Accessories for Exteral Fixator

code	Description	code	Description
D1001	Straight Clamp	D6001AL	Φ 14 Rod(Aluminium) 300mm
D1007	Straight Clamp(Paediatric)	D6002AL	Φ 14 Rod(Aluminium) 200mm
D1002	T-type Clamp	D6003AL	Φ 14 Rod(Aluminium) 100mm
D1008	T-type Clamp(Paediatric)	D6004AL	Φ 12 Rod(Aluminium) 300mm
D1021	Triangle Clamp	D6005AL	Φ 12 Rod(Aluminium) 200mm
D1020	Big T-type Clamp	D6006AL	Φ 12 Rod(Aluminium) 100mm
D1004	Ankle Clamp (With three holes)	D6006AL	Φ 9 Rod(Aluminium) 300mm
D1005	Oblique Clamp	D6007AL	Φ 9 Rod(Aluminium) 200mm
D2015	L.R.S T-type Clamp	D6007AL	Φ 9 Rod(Aluminium) 100mm
D2019	L.R.S Micrometric Swivelling Clamp	D6008AL	Φ 9 Rod(Aluminium) 300mm
D2021	L.R.S Multiplanar Clamp	D6009AL	Φ 9 Rod(Aluminium) 200mm
D2047	L.R.S T-type Clamp (Paediatric)	D6010AL	Φ 9 Rod(Aluminium) 100mm
D3001	Extended Range Clamp for Elbow	D6010AL	Φ 9 Rod(Aluminium) 100mm
D4001	L-type Clamp for Wrist	D6011AL	Φ 6 Rod(Aluminium) 300mm
D6025	14mm Rod-Rod Clamp	D6011AL	Φ 6 Rod(Aluminium) 200mm
D6026	12mm Rod-Rod Clamp	D6012AL	Φ 6 Rod(Aluminium) 100mm
D6027	9mm Rod-Rod Clamp	D6001Ts	Φ 6 Rod(Aluminium) 300mm
D6029	14mm Rod-Screw Clamp	D6002Ts	Φ 6 Rod(Aluminium) 200mm
D6030	12mm Rod-Screw Clamp	D6003Ts	Φ 6 Rod(Aluminium) 100mm
D6031	9mm Rod-Screw Clamp	D6003Ts	Φ 14 Rod (Carbon) 350mm
D6028	6mm Rod-Rod Clamp	D6004Ts	Φ 14 Rod (Carbon) 250mm
D6010Cr	Φ 6 Rod(SS) 300mm	D6005Ts	Φ 14 Rod (Carbon) 150mm
D6011Cr	Φ 6 Rod(SS) 200mm	D6006Ts	Φ 12 Rod (Carbon) 350mm
D6012Cr	Φ 6 Rod(SS) 100mm	D6007Ts	Φ 12 Rod (Carbon) 250mm
		D6008Ts	Φ 12 Rod (Carbon) 150mm
		D6009Ts	Φ 9 Rod (Carbon) 350mm
		D6010Ts	Φ 9 Rod (Carbon) 250mm
		D6011Ts	Φ 9 Rod (Carbon) 150mm
		D6012Ts	Φ 6 Rod (Carbon) 350mm
			Φ 6 Rod (Carbon) 250mm
			Φ 6 Rod (Carbon) 150mm

Accessories for Exteral Fixator

code	Description	code	Description
D6001Ti	Φ 14 Rod(TA) 350mm	H7153	2/3 Ring 120mm
D6002Ti	Φ 14 Rod(TA) 250mm	H7001	2/3 Ring 150mm
D6003Ti	Φ 14 Rod(TA) 150mm	H7002	2/3 Ring 175mm
D6004Ti	Φ 12 Rod(TA) 350mm	H7003	2/3 Ring 190mm
D6005Ti	Φ 12 Rod(TA) 250mm	H7004	2/3 Ring 220mm
D6006Ti	Φ 12 Rod(TA) 150mm	H7154	1/3 Ring 120mm
D6007Ti	Φ 9 Rod(TA) 350mm	H7005	1/3 Ring 150mm
D6008Ti	Φ 9 Rod(TA) 250mm	H7006	1/3 Ring 175mm
D6009Ti	Φ 9 Rod(TA) 150mm	H7007	1/3 Ring 190mm
D6010Ti	Φ 6 Rod(TA) 350mm	H7008	1/3 Ring 220mm
D6011Ti	Φ 6 Rod(TA) 200mm	H7014	Round Ring 80mm
D6012Ti	Φ 6 Rod(TA) 100mm	H7015	Round Ring 100mm
D6013AL	Φ 14 Curved Rod (Aluminium)	H7016	Round Ring 120mm
D6014AL	Φ 14 Curved Rod (Aluminium)	H7017	Round Ring 130mm
D6015AL	Φ 14 Curved Rod (Aluminium)	H7018	Round Ring 140mm
D6016AL	Φ 12 Curved Rod (Aluminium)	H7019	Round Ring 150mm
D6017AL	Φ 12 Curved Rod (Aluminium)	H7020	Round Ring 160mm
D6018AL	Φ 12 Curved Rod (Aluminium)	H7021	Round Ring 170mm
D6019AL	Φ 9 Curved Rod (Aluminium)	H7022	Round Ring 180mm
D6020AL	Φ 9 Curved Rod (Aluminium)	H7023	Round Ring 200mm
D6021AL	Φ 9 Curved Rod (Aluminium)	H7024	Round Ring 220mm
D6022AL	Φ 6 Curved Rod (Aluminium)	H7025	Round Ring 240mm
D6023AL	Φ 6 Curved Rod (Aluminium)	H7040	Foot Ring 120mm
D6024AL	Φ 6 Curved Rod (Aluminium)	H7043	Foot Ring 150mm
D6022Cr	Φ 6 Curved Rod (SS)	H7045	Foot Ring 170mm
D6023Cr	Φ 6 Curved Rod (SS)	H7047	Foot Ring 200mm
D6024Cr	Φ 6 Curved Rod (SS)	H7028	Half Ring 120mm

Accessories for External Fixator

Code	Description	Code	Description
H7031	half ring 150mm	H7148	Threaded Rod 300mm
H7033	half ring 170mm	H7149	Threaded Rod 350mm
H7035	half ring 200mm	H7150	Threaded Rod 400mm
H7013	Ring Clamp	H8001	Hybird Coupling For Micro-movement Fixator
H7009	Clamp with 3 holes	D2016	Ball-joint coupling for L.R.S
H7010	Clamp with 2 holes		
H7011	Post		
H7012	Pin Clamp		
H7136	Distractor (M)		
H7137	Distractor (L)		
H7122	Inline Hinge		
H7123	Outboard hinge		
H7124	Pin Bolt 6mm		
H7125	Pin Bolt 2mm		
H7126	1 hole post		
H7127	2 hole post		
H7128	3 hole post		
H7129	4 hole post		
H7140	Threaded Rod 60mm		
H7141	Threaded Rod 80mm		
H7142	Threaded Rod 110mm		
H7143	Threaded Rod 120mm		
H7144	Threaded Rod 150mm		
H7145	Threaded Rod 180mm		
H7146	Threaded Rod 200mm		
H7147	Threaded Rod 250mm		

ZS10 Mini System



Rod to Rod Coupling

code:ZS102001
material:SS,Aluminum Alloy



Pin to Rod Coupling

code:ZS102002
material:SS,Aluminum Alloy



Inverted Pin to rod Coupling

code:ZS102012
material:SS,Aluminum Alloy



Double Pin to Rod Coupling

code:ZS102003
material:SS,Aluminum Alloy



Inverted Double Pin to rod Coupling

code:ZS102013
material:SS,Aluminum Alloy



Multi-Pin Clamp

code:ZS102002
material:SS,Aluminum Alloy



Schanz Pin

code:ZSA18-45
material:SS

Carbon Conecting Rod $\phi 3 \times 50$

code:ZS106050
material:Carbon

Carbon Conecting Rod $\phi 3 \times 100$

code:ZS106100
material:Carbon

Carbon Conecting Rod $\phi 3 \times 150$

code:ZS106150
material:Carbon

ZS9 Upper limbs



Rod to Rod Coupling

code:ZS92001
material:SS,Aluminum Alloy



Pin to rod Coupling

code:ZS92002
material:SS,Aluminum Alloy



Inverted Pin to rod Coupling

code:ZS92012
material:SS,Aluminum Alloy



Double Pin to Rod Coupling

code:ZS92003
material:SS,Aluminum Alloy



Inverted Double Pin to rod Coupling

code:ZS92013
material:SS,Aluminum Alloy



5-Hole Pin Clamp

code:ZS91004
material:SS,Aluminum Alloy



Multi-Pin Clamp

code:ZS91002
material:SS,Aluminum Alloy

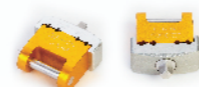

Joint Clamp

code:ZS91003
material:SS,Aluminum Alloy



30° Angled Post

code:ZS93003
material:SS



Straight Post

code:ZS93001
material:SS



Connecting Rod for Elbow (Short)

code:ZS99001
material:SS



Connecting Rod for Elbow (Long)

code:ZS99002
material:SS



Connecting Rod for Wrist

code:ZS99003
material:SS



Carbon Connecting Rod Φ 5X50	ZS96050	
Carbon Connecting Rod Φ 5X100	ZS96100	
Carbon Connecting Rod Φ 5X150	ZS96150	Carbon
Carbon Connecting Rod Φ 5X200	ZS96200	
Carbon Connecting Rod Φ 5X250	ZS96250	

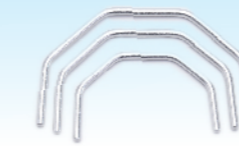

Semi-Circular Rod (S)	ZS97001	
Semi-Circular Rod (M)	ZS97002	SS
Semi-Circular Rod (L)	ZS97003	



Hex Pin Driver

code:G20002
material:SS,Aluminum Alloy



Guid for Pin

code:G20004
material:SS



Thumbwheel

code:G20006-01
material:Aluminum Alloy



Reduction Wrench

code:G20008
material:SS,Aluminum Alloy



Schanz Pin

code:ZSA40-120
material:SS



T-Wrench

code:G20010
material:SS,Aluminum Alloy



Multi-Pin Insertion Guid

code:G20012
material:SS



Manual Drill Handle

code:G200014
material:SS



Schanz Pin

code:ZSA30-80
material:SS,Aluminum Alloy



Pin holder

code:G20016
material:SS

ZS9 Lower Limbs:Rod&Instruments

Description	code	material
SS Connecting Rod Φ 5X50	ZS95050	
SS Connecting Rod Φ 5X100	ZS95100	
SS Connecting Rod Φ 5X150	ZS95150	SS
SS Connecting Rod Φ 5X200	ZS95200	
SS Connecting Rod Φ 5X250	ZS95250	

SK-ZS Universal Set For Upper Limbs

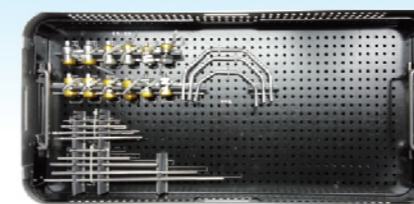

Upper Floor

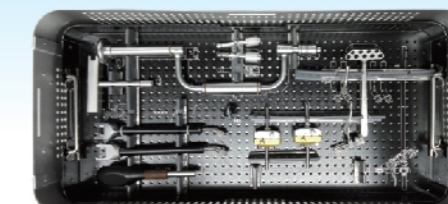

Down Floor

ZS8 Lower Limbs



Rod to Rod Coupling

code:ZS82001
material:SS,Aluminum Alloy



Pin to rod Coupling

code:ZS82002
material:SS,Aluminum Alloy



Inverted Pin to rod Coupling

code:ZS82012
material:SS,Aluminum Alloy



Double Pin to Rod Coupling

code:ZS82003
material:SS,Aluminum Alloy



Inverted Double Pin to rod Coupling

code:ZS82013
material:SS,Aluminum Alloy



5-Hole Pin Clamp

code:ZS81001
material:SS,Aluminum Alloy



Multi-Pin Clamp

code:ZS81002
material:SS,Aluminum Alloy



30° Angled Post

code:ZS83003
material:SS



Straight Post

code:ZS83001
material:SS



Dynamization Tube (Single)

code:ZS88001
material:SS,Aluminum Alloy



Connecting Rod for Ankle

code:ZS89003
material:SS



Compression/Distract Tube (M)

code:ZS88004
material:SS,Aluminum Alloy

Compression Rod to pin Coupling

code:ZS88014
material:SS,Aluminum Alloy



Connecting Rod for Knee (L)

code:ZS89001
material:SS

Connecting Rod for Knee (R)

code:ZS89002
material:SS



Adjustable Tube (Short)

code:ZS88021
material:SS,Aluminum Alloy

Adjustable Tube (Long)

code:ZS88022
material:SS,Aluminum Alloy

	Carbon Connecting Rod Φ 8X150	ZS86150	Carbon
	Carbon Connecting Rod Φ 8X200	ZS86200	
	Carbon Connecting Rod Φ 8X250	ZS86250	
	Carbon Connecting Rod Φ 8X300	ZS86300	
	Carbon Connecting Rod Φ 8X350	ZS86350	
	Carbon Connecting Rod Φ 8X400	ZS86400	

	Semi-Circular Rod (S)	ZS87001	SS
	Semi-Circular Rod (M)	ZS87002	
	Semi-Circular Rod (L)	ZS87003	



Hex Pin Driver

code:G20001
material:SS,Aluminum Alloy



Guid for Pin

code:G20005
material:SS



Thumbwheel

code:G20006-02
material:Aluminum Alloy



Reduction Wrench

code:G20009
material:SS,Aluminum Alloy



Torque limited Wrench

code:G20011
material:SS,Aluminum Alloy



T-Wrench

code:G20010
material:SS



Multi-Pin Insertion Guid

code:G20012
material:SS



Manual Drill Handle

code:G20014
material:SS,Aluminum Alloy



Schanz Pin

code:ZSA50-150



Schanz Pin

code:ZSA50-120



Pin holder

code:G20017

ZS8 Lower Limbs:Rod&Instruments

Description	code	material
Aluminum Connecting Rod Φ 8X150	ZS84150	Aluminum
Aluminum Connecting Rod Φ 8X200	ZS84200	
Aluminum Connecting Rod Φ 8X250	ZS84250	
Aluminum Connecting Rod Φ 8X300	ZS84300	
Aluminum Connecting Rod Φ 8X350	ZS84350	
Aluminum Connecting Rod Φ 8X400	ZS84400	

SK-ZS Universal Set For Lower Limbs

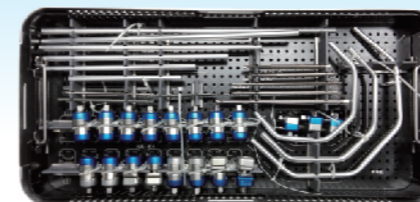

Upper Floor

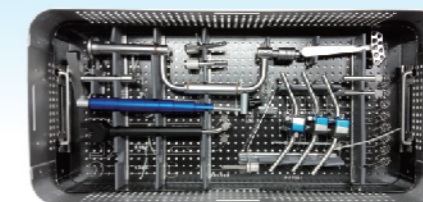

Down Floor

Universal Set For Upper Limbs & Pediatric

Universal Mini-fixator Set for Hand& feet

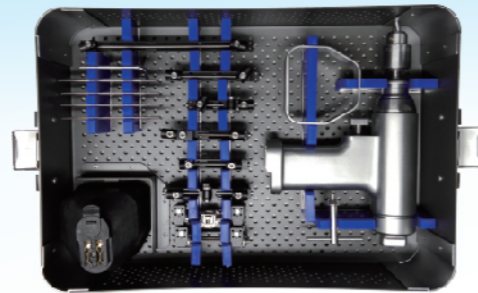

Universal Set for Elbow

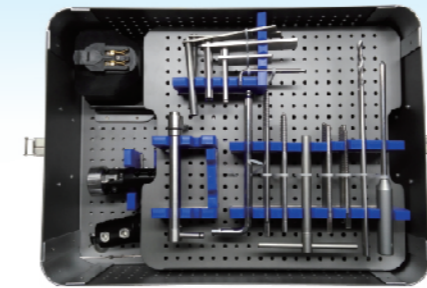

Upper Floor

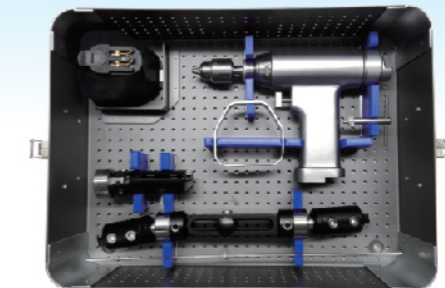

Down Floor

Universal Set for L.R.S

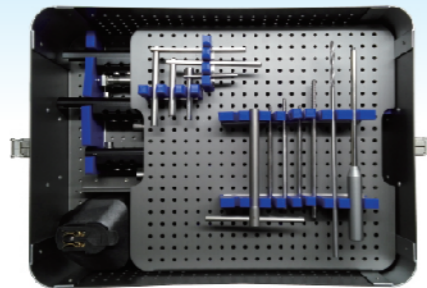

Upper Floor

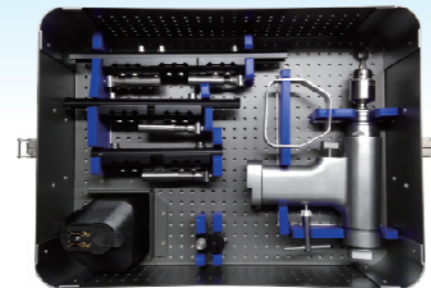

Down Floor

Universal Set for Upper Limbs & Pediatric

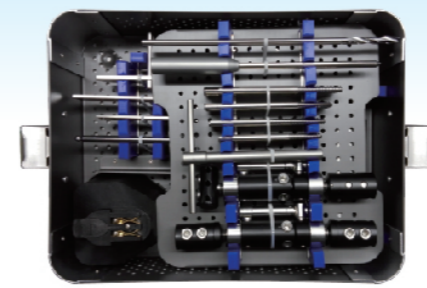

Upper Floor

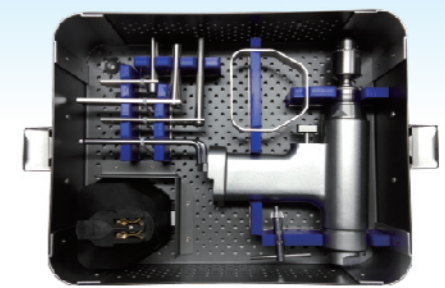

Down Floor

Universal Set for Wrist fixator

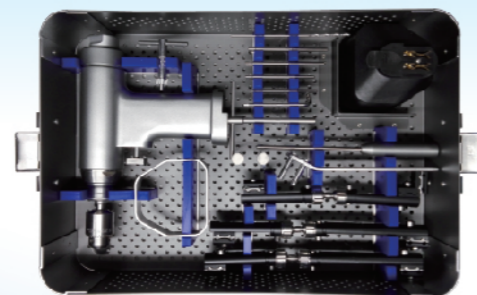

Sterilization Package for Radiolucent Wrist Fixator.



Universal Set For Lower Limbs

Universal Set for Lower Limbs

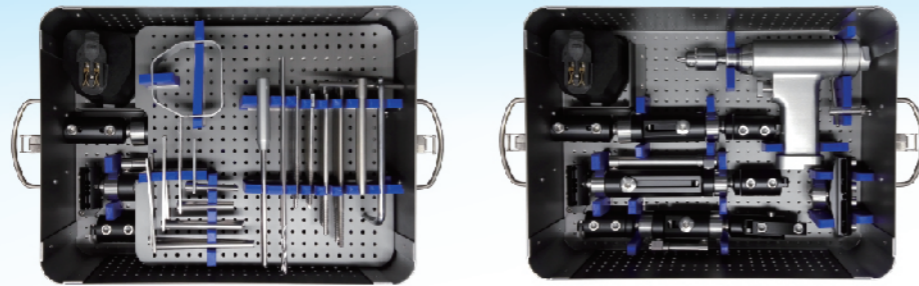

Upper Floor

Down Floor

Universal Set for Pelvis

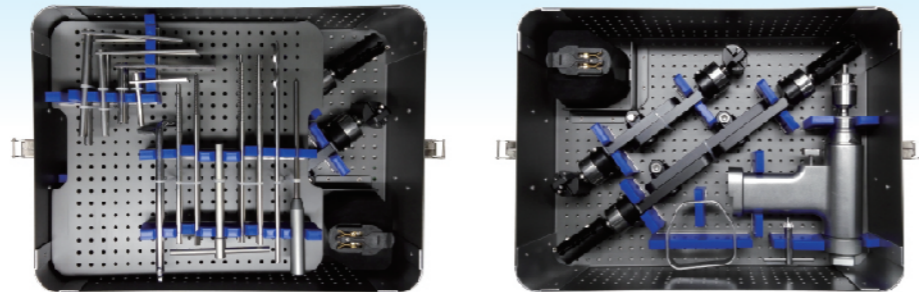

Upper Floor

Down Floor

Universal Set for L.R.S

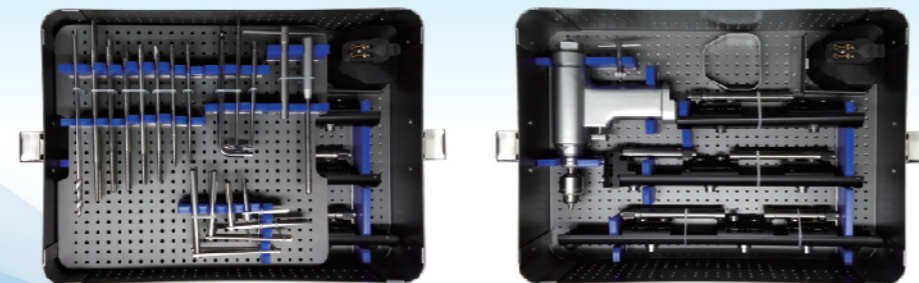

Upper Floor

Down Floor

Universal Set for Semi-Ring Fixator

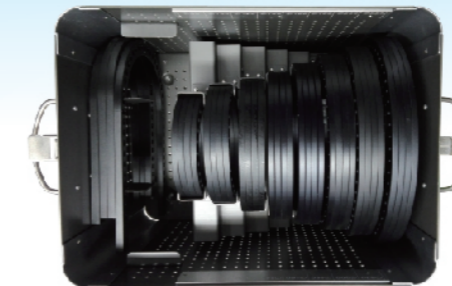

Universal Set for Ring Fixator



Upper Floor

Down Floor