

Power System

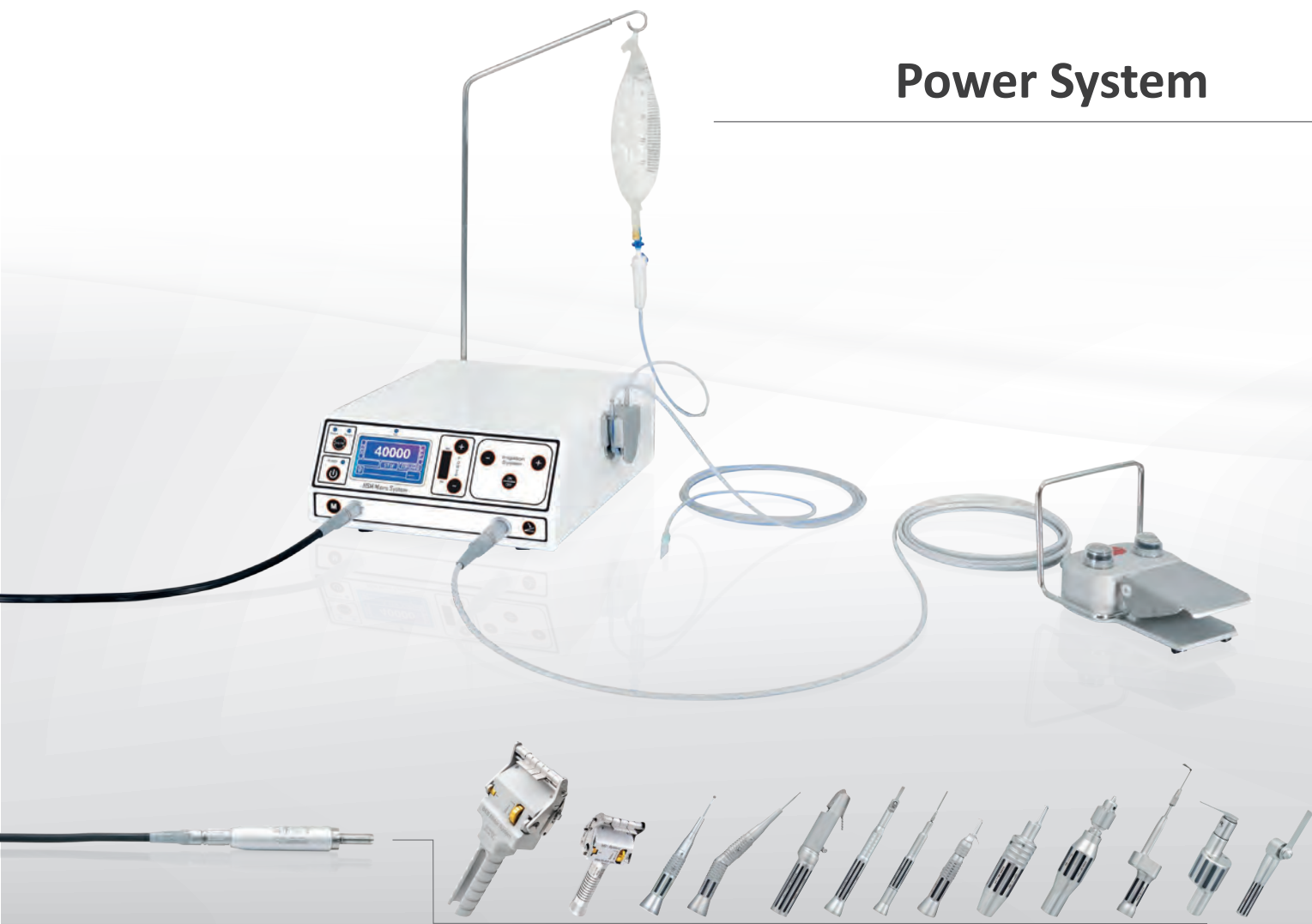

HSM *Micro System*

www.aygun.com

AYGÜN[®]
SURGICAL INSTRUMENTS CO., INC.

Organize Sanayi Bölgesi 55330
Kutlukent - SAMSUN / TÜRKİYE
Tel : 90 (362) 266 66 80 pbx
Fax : 90 (362) 266 93 30 pbx
E-Mail : aygun@aygun.com
Web : <http://www.aygun.com>

2015

■ According to the production programme
Aygün's rights is reserved in production to improve,
modify or delete the products declared in this catalog.

KA - 4016-Y1 Copyright © Aygün Co., Inc
2015 All Right Reserved, Printed in Türkiye



AYGÜN is one of the leading establishment of Turkey in the medical industrial field, starting from neurosurgical field since 1988, at the end of its constant R&D researches, has accomplished the production of instruments for all surgical branches. Along with meeting a large part of Turkey's requirements, AYGÜN proves itself as an expert in the field with the products offered to the world market.

With present catalogues that include standard products and the special products formed on the request of the doctors including thousands of types medical products produced by AYGÜN Besides being a manufacturer, AYGÜN is also a designer firm.

Besides increasing its capacity, AYGÜN, in its new production plants constructed in the Organized Industrial Area of Samsun, aims to present the different models of products to the medical community.





- M14 - 700
Power console
- Operating Speed: 40.000 rpm (Adjustable Maximum Speed)
 - Operating Voltage: 200-240 V
 - Power: 260 W
 - Irrigation Flow Rate: 100 ml/min (Adjustable Maximum Flow Rate)
 - Frequency : 50-60 Hz
 - Dimensions: 350x280x110 mm
 - Weight : 5.060 kg



- M6 - 054
Foot pedal, with irrigation and F/R buttons
- Cable Length: 4 m
 - Dimensions: 200x155x150 mm
 - Weight: 1.560 kg



- M14 - 310
Motor Cable
- Autoclavable
 - Cable length: 4 m
 - Weight: 490 g



- M14 - 800
Swiss Made
Powerful Brushless
DC Motor Technology
- Autoclavable
 - Operating Speed: 40.000 rpm (Adjustable Maximum Speed)
 - Power: 150 W
 - Dimensions: 130x22 mm
 - Weight: 0.160 kg

HSM Micro System

- > GRAPHICAL LCD ON THE POWER CONSOLE SHOWS ADJUSTED MOTOR SPEED, ROTATION DIRECTION, IRRIGATION PUMP FLOW RATE, PEDAL MOTOR CONNECTION FAILURE INDICATOR.
- > BARLED DISPLAY SHOWS SPEED DEMAND.
- > FOOT PEDAL FOR SPEED, DIRECTION AND IRRIGATION CONTROL.
- > AUTOCLAVABLE SWISS MADE POWERFUL BRUSHLESS DC MOTOR
- > ADJUSTABLE SPEED RANGE UP TO 40.000 RPM!
- > UNDER LOAD MOTOR START-UP TECHNOLOGY PREVENTING THE FAILURES RELATED TO MOTOR OBSTRUCTION DURING OPERATION!
- > LOW COST OF CONSUMABLE IRRIGATION PUMP!



CONTENTS



PAGE	ATTACHMENT
 8	INTRA MAIN PIECE STRAIGHT
 9	INTRA MAIN PIECE ANGULAR
 16-17	HAND PIECES ANGULAR
 18	MICRO SURGERY ATTACHMENT
 19	SKIN ABRASION
 20	FREIBURG CRANIOTOME
 20	MICRO OSCILLATING SAW
 21	MICRO SAGITTAL ATTACHMENT
 22	CRANIOTOME
 23	MICRO STRAIGHT RECIPROCATING ATTACHMENT
 24-25	MICRO DRILL
 26-27	SHAVER (ARTROSCOPIC SYSTEM)
 28-29	MICRO OSCILLATING ATTACHMENT
 30-31	SMALL SAGITTAL ATTACHMENT
 32-33	DRILL RW/FW

ATTACHMENT	PAGE
MINI DRILL ATTACHMENT	34-35
MINI OSCILLATING ATTACHMENT	36-37
MINI SAGITTAL ATTACHMENT	38-39
MINI STRAIGHT RECIPROCATING ATTACHMENT	40-41
WIRE DRIVER	42
MMS PERFORATOR DRIVE	43
DERMATOME & Skin Graft Mesher	
DERMATOME BATTERY	48-49
DERMATOME ELECTRO	50-51
DERMATOME BATTERY & ELECTRO	52-53
DERMATOME ELECTRO	54-55
MINI DERMATOME ELECTRO	56-57
DERMATOME PNEUMATIC STANDARD	58-59
MINI DERMATOME PNEUMATIC STANDARD	60-61
SKIN GRAFT MESHER	62-63
INDEX	66-68

INTRA MAIN PIECE STRAIGHT

INTRA MAIN PIECE ANGULAR

• Please see pages 10-11-12 for suitable burr-shank for M8-201

• Please see pages 10-11-12 for suitable burr-shank for M8-210

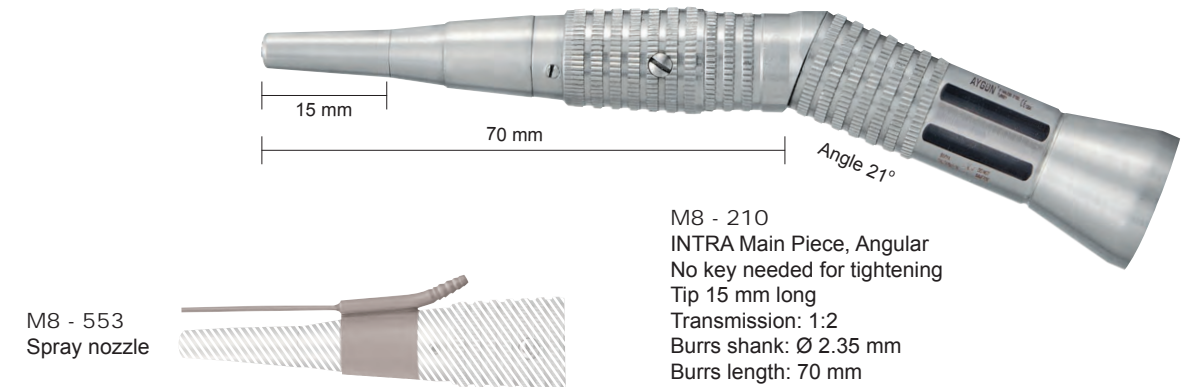
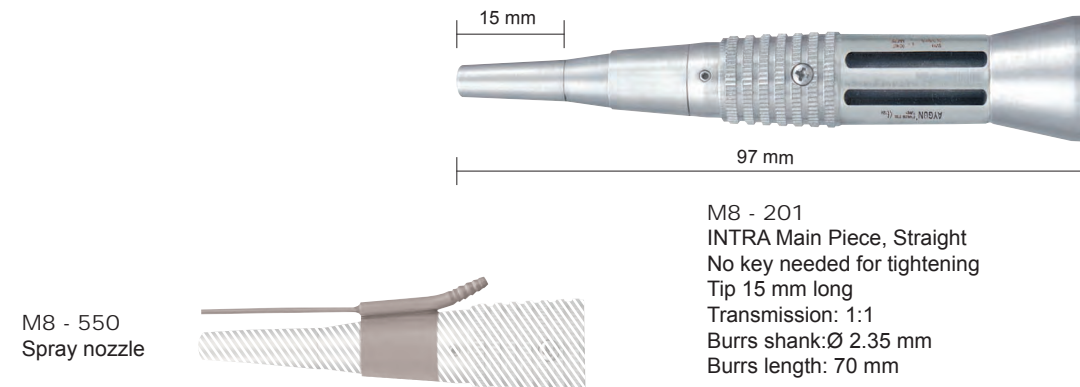

• Please see page 13 for suitable burr-shank for M8-202

• Please see page 13 for suitable burr-shank for M8-211

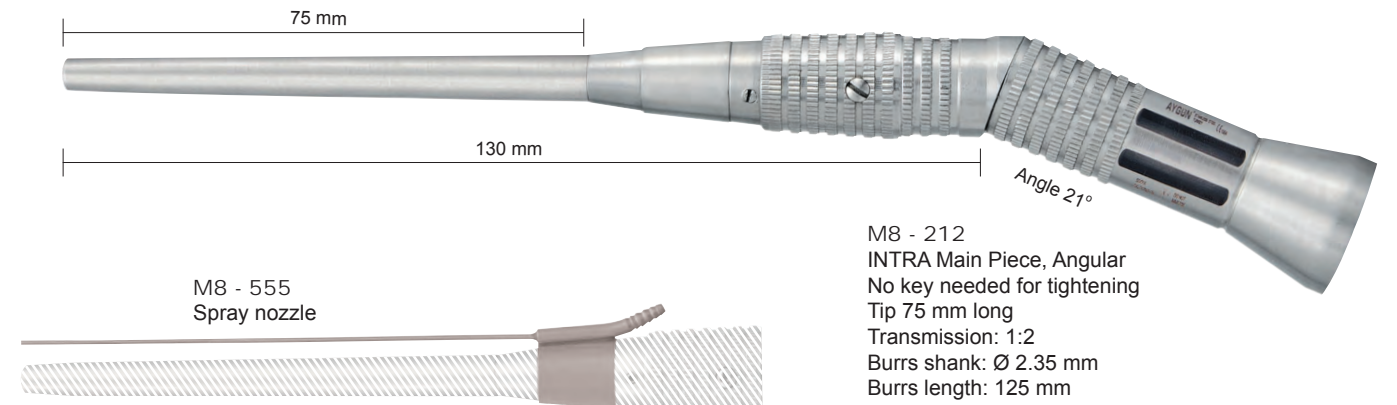
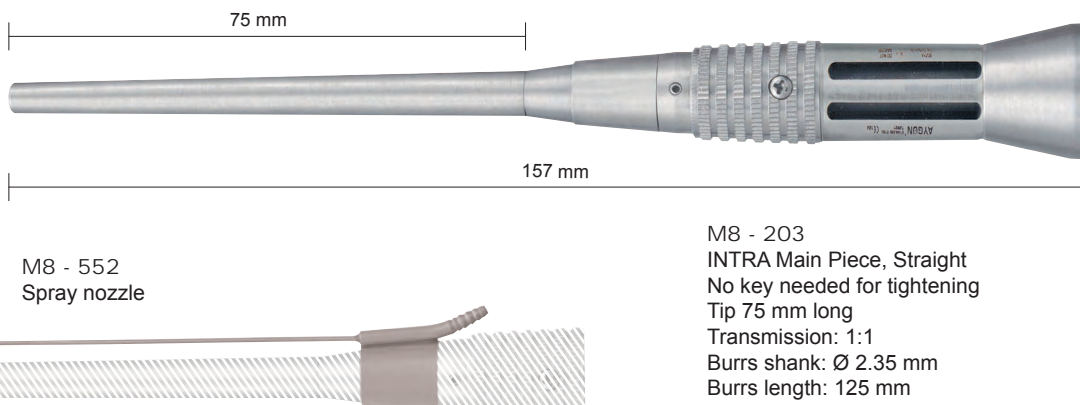
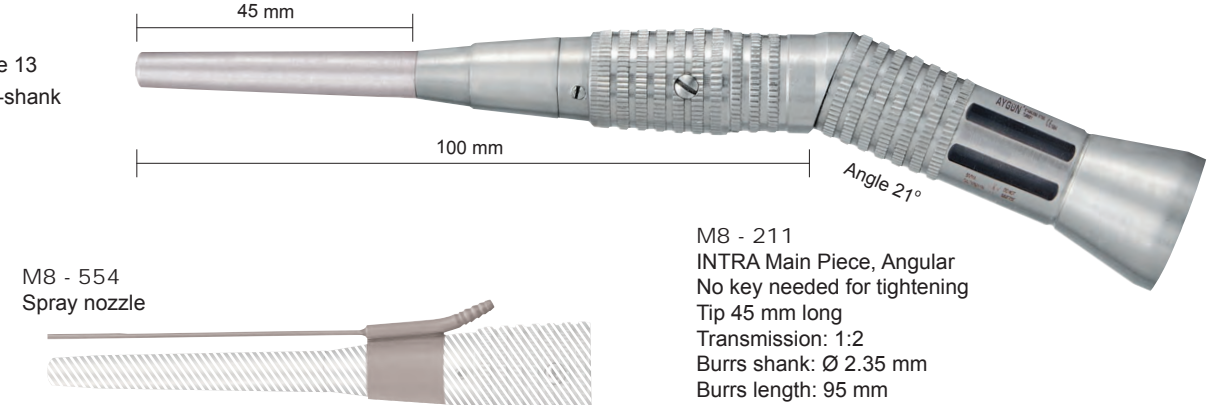
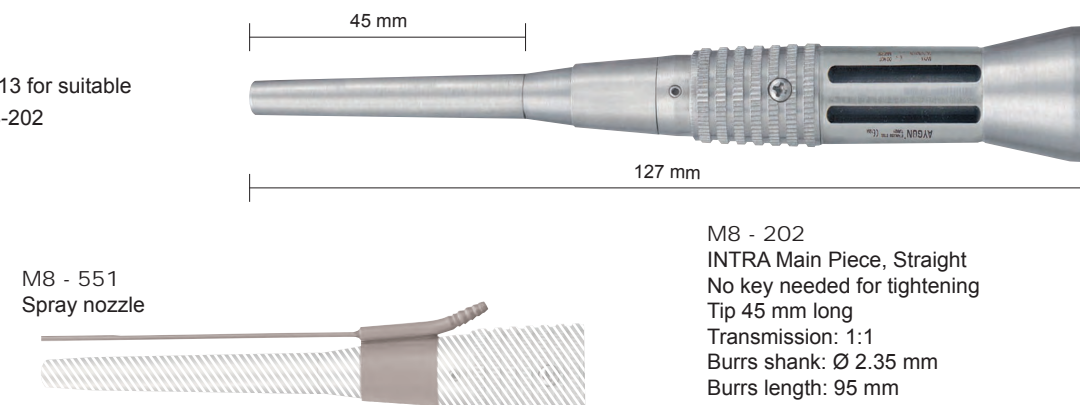

• Please see pages 14-15 for suitable burr-shank for M8-203

• Please see pages 14-15 for suitable burr-shank for M8-212

BURR-SHANK

70 MM LONG, SHANK Ø 2.35 MM, ROUND SHANK



M8-210



M8-201



M8-160

• Suitable Burr-Shank types for M8-201, M8-210 and M8-160

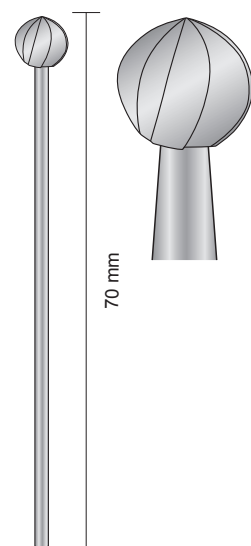

Standard Burrs
Stainless steel

	Code	Size	Ø mm	ISO - NO
	M8 - 300	20	5.0	050
	M8 - 302	16	4.0	045
	M8 - 304	12	3.1	035
	M8 - 306	8	2.3	027
	M8 - 308	4	1.4	018
	M8 - 310	0	0.8	008
	M8 - 312	000	0.6	006

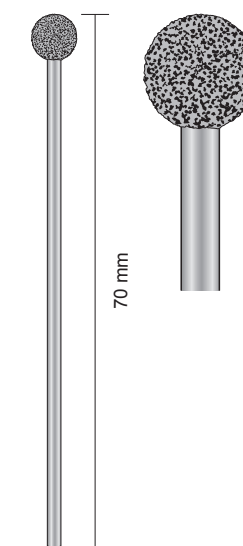

Diamond Burrs

	Code	Size	Ø mm	ISO - NO
	M8 - 340	24	7.0	070
	M8 - 342	20	5.0	050
	M8 - 344	16	4.0	045
	M8 - 346	12	3.1	035
	M8 - 348	8	2.3	027
	M8 - 350	4	1.4	018
	M8 - 352	0	0.8	008
	M8 - 354	000	0.6	006

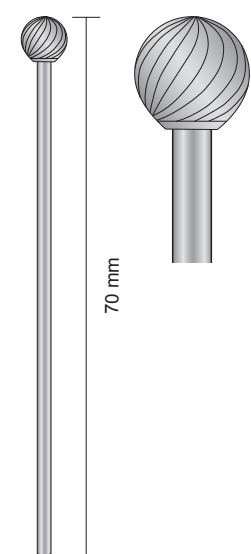

High speed Burrs
Carbide

	Code	Size	Ø mm	ISO - NO
	M8 - 320	24	7.0	070
	M8 - 322	20	5.0	050
	M8 - 324	16	4.0	045
	M8 - 326	12	3.1	035
	M8 - 328	8	2.3	027
	M8 - 330	4	1.4	018
	M8 - 332	0	0.8	008
	M8 - 334	000	0.6	006

BURR-SHANK

70 MM LONG, SHANK Ø 2.35 MM, ROUND SHANK

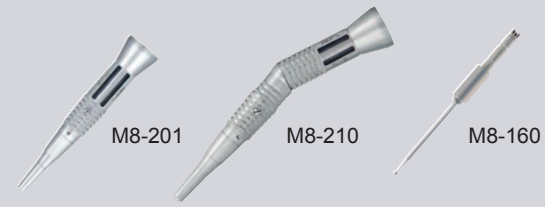

- Suitable Burr-Shank types for M8-201, M8-210 and M8-160

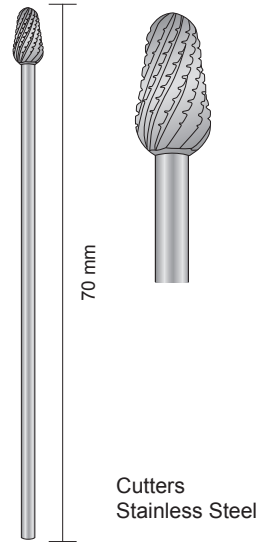

	Code	Size	Ø mm
	M8 - 381	32	8.0
	M8 - 383	24	6.0
	M8 - 385	20	5.0
	M8 - 386	16	4.0

Cutters
Stainless Steel

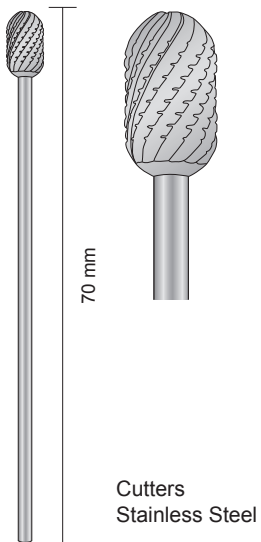

	Code	Size	Ø mm
	M8 - 391	32	8.0
	M8 - 393	28	7.0
	M8 - 395	24	6.0
	M8 - 396	20	5.0
	M8 - 397	16	4.0

Cutters
Stainless Steel

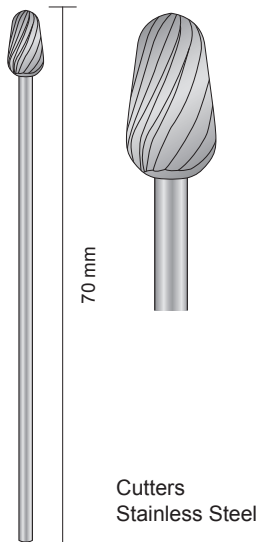

	Code	Size	Ø mm
	M8 - 401	32	8.0
	M8 - 403	28	7.0
	M8 - 405	24	6.0
	M8 - 406	20	5.0
	M8 - 407	16	4.0

Cutters
Stainless Steel

BURR-SHANK

95 MM LONG, SHANK Ø 2.35 MM, ROUND SHANK



- Suitable Burr-Shank types for M8-202, M8-211

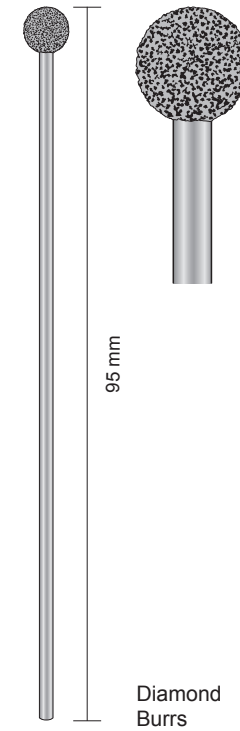

	Code	Size	Ø mm	ISO - NO
	M8 - 410	20	5.0	050
	M8 - 412	16	4.0	040
	M8 - 414	12	3.1	031
	M8 - 416	8	2.3	023
	M8 - 418	4	1.4	014

Diamond
Burs

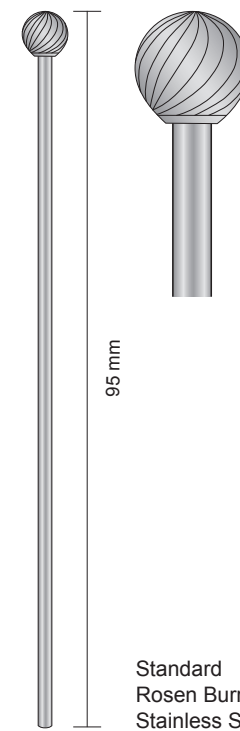

	Code	Size	Ø mm	ISO - NO
	M8 - 420	20	5.0	050
	M8 - 422	16	4.0	040
	M8 - 424	12	3.1	031
	M8 - 426	8	2.3	023
	M8 - 428	4	1.4	014

Standard
Rosen Burs
Stainless Steel

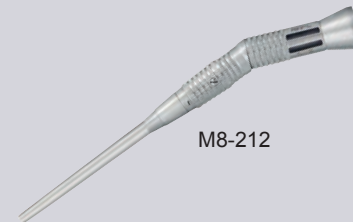

BURR-SHANK

125 MM LONG, SHANK Ø 2.35 MM, ROUND SHANK

- Suitable Burr-Shank types for M8-203, M8-212

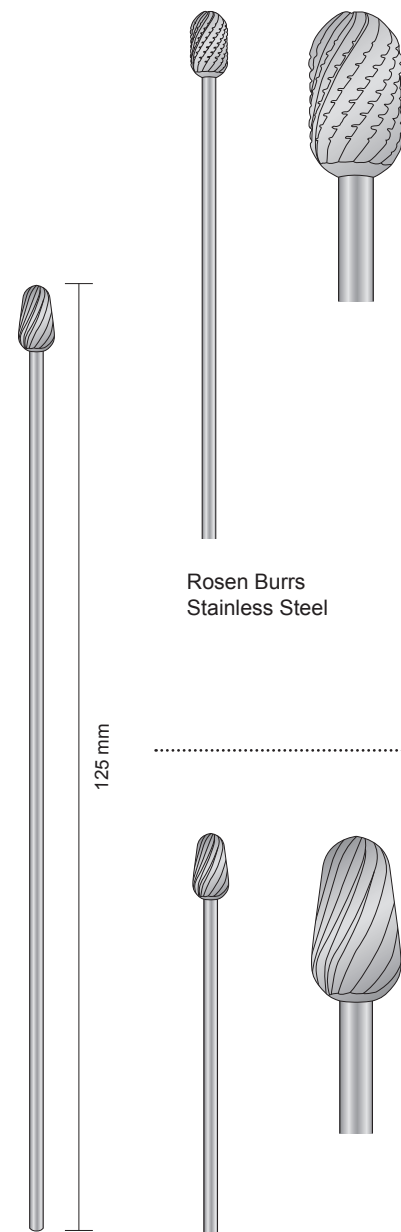

Rosen Burrs
Stainless Steel

	Code	Size	Ø mm
	M8 - 431	32	8.0
	M8 - 433	28	7.0
	M8 - 434	24	6.0
	M8 - 435	20	5.0
	M8 - 436	16	4.0

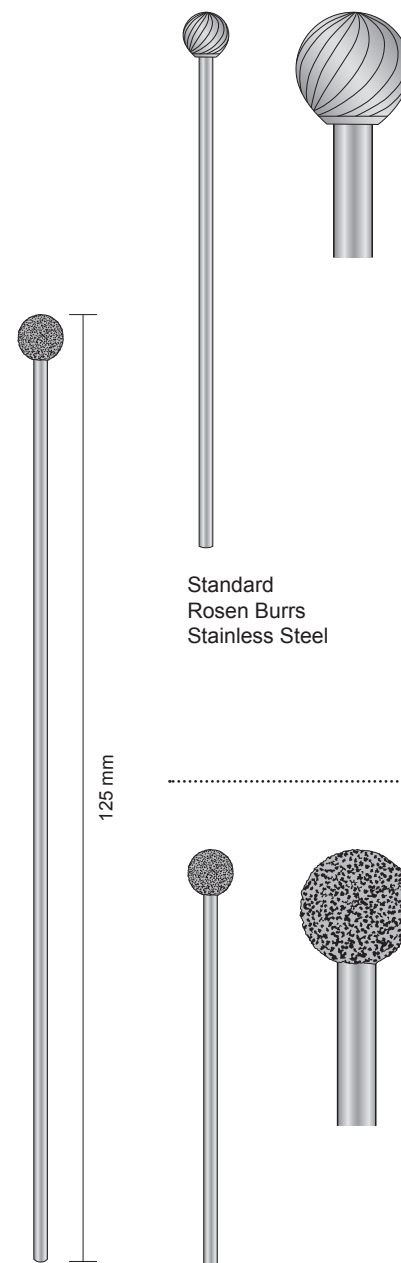

Standard
Rosen Burrs
Stainless Steel

	Code	Size	Ø mm	ISO - NO
	M8 - 450	20	5.0	050
	M8 - 452	16	4.0	040
	M8 - 454	12	3.1	031
	M8 - 456	8	2.3	023
	M8 - 458	4	1.4	014

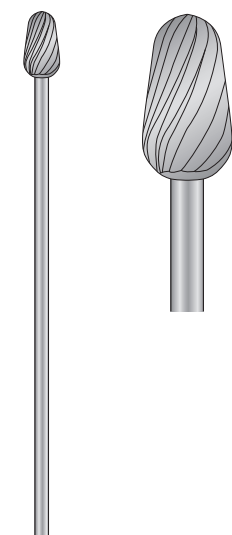

Rosen Burrs
Stainless Steel

	Code	Size	Ø mm
	M8 - 441	32	8.0
	M8 - 443	28	7.0
	M8 - 444	24	6.0
	M8 - 445	20	5.0
	M8 - 446	16	4.0

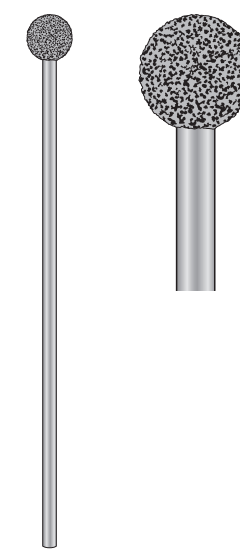

Diamond
Burrs

	Code	Size	Ø mm	ISO - NO
	M8 - 460	20	5.0	050
	M8 - 462	16	4.0	040
	M8 - 464	12	3.1	031
	M8 - 466	8	2.3	023
	M8 - 468	4	1.4	014

HAND PIECES ANGULAR

HAND PIECES ANGULAR



M8 - 556
Spray nozzle

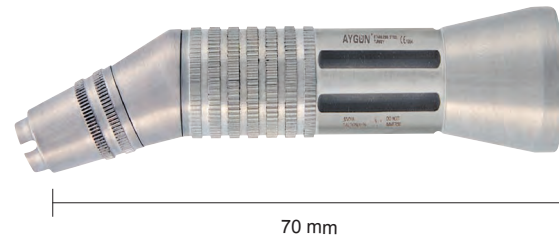

M8 - 150
INTRA Main Piece, Angular
No key needed for tightening
Angle: 21°
Transmission: 1:1
Color marked: One Blue Ring
The burrs can be mounted
with M8-160 imperator



M8 - 557
Spray nozzle

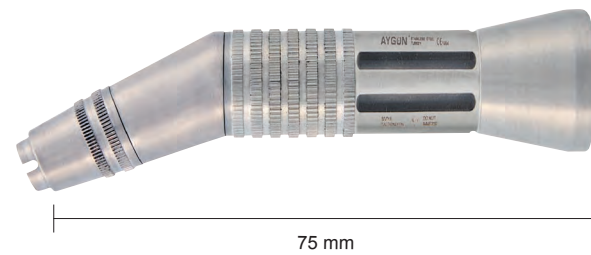

M8 - 151
INTRA Main Piece, Angular
No key needed for tightening
Angle: 21°
Transmission: 1:2
Color marked: Two Red Rings
The burrs can be mounted
with M8-160 imperator



M8 - 558
Spray nozzle

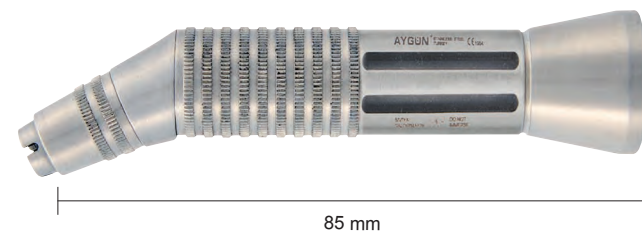

M8 - 152
INTRA Main Piece, Angular
No key needed for tightening
Angle: 21°
Transmission: 2.7:1
Color marked: One Green Ring
The burrs can be mounted
with M8-160 imperator

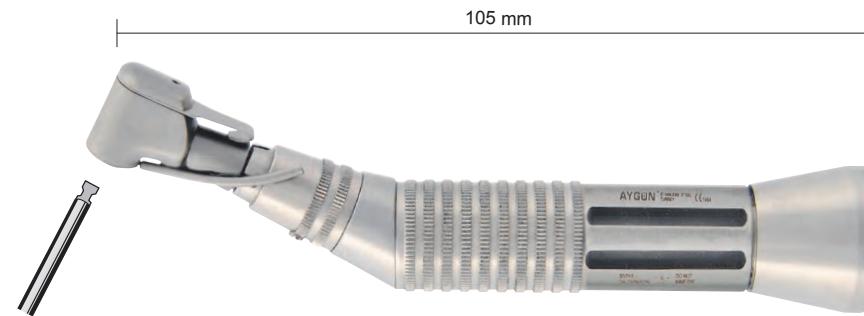

M8 - 180
Angular head
Angle: 21°
Consisting of: M8-152 and M8-181



M8 - 181
Angle head with imperator bearing.
Transmission: 2:1
For burrs and cutters
With quick-action "dental" shaft

	Code	Ø mm
	M8 - 182	1.8
	M8 - 183	2.5
	M8 - 184	3.1
	M8 - 185	4.0

Code	Ø	Length
M8 - 580	1.1	23
M8 - 581	1.5	23
M8 - 582	1.8	23
M8 - 583	2.0	23
M8 - 584	2.1	30



Code	Ø	Length
M8 - 595	1.5	38
M8 - 596	2.0	38



Code	Length
M8 - 600	25 mm
M8 - 601	50 mm



MICRO SURGERY ATTACHMENT

SKIN ABRASION

• Please see pages 10-11-12 for suitable burr-shank for M8-160



M8 - 160
Micro surgery attachment with imperator bearing, for burrs drills etc. With standard shank of Ø 2.35 mm and a length of up to 70 mm, can be used for burrs.



M8 - 170
Chuck for tightening and exchanging burrs, drills ect. For standard shanks of Ø 2.35 mm in the micro surgery attachment M8-160

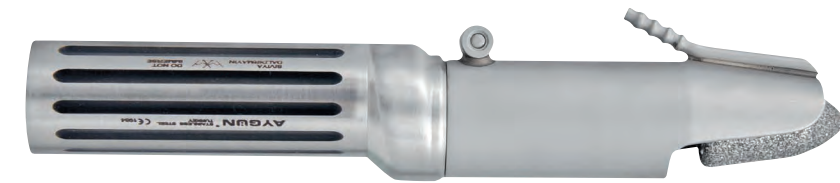

M8 - 485
Hand piece for skin abrasion, With irrigation tube integrated in the protection shield, diamond grinding attachment. Smooth running due to ball bearings and taper socket of the grinding attachment.

Application of the micro surgery attachment

M8 - 160
Micro surgery attachment

put micro surgery attachment into the chuck



Burr, mounted group of micro surgical attachment and intra main piece



Burr with standard shank, Ø 2.35 mm 70 mm length



Insert burr right to the stop into the micro surgery attachment

M8 - 170
Chuck
Fix the tool in the micro surgery attachment by clocwise turning. remove by turning to the left

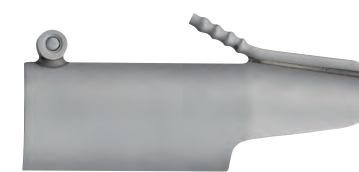
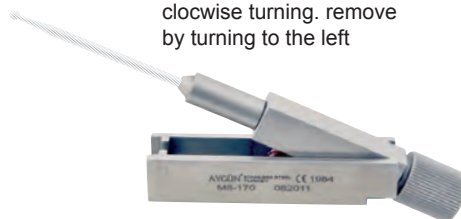

M8 - 486
Protection shield



M8 - 487
Grinding attachment

MICRO ATTACHMENT

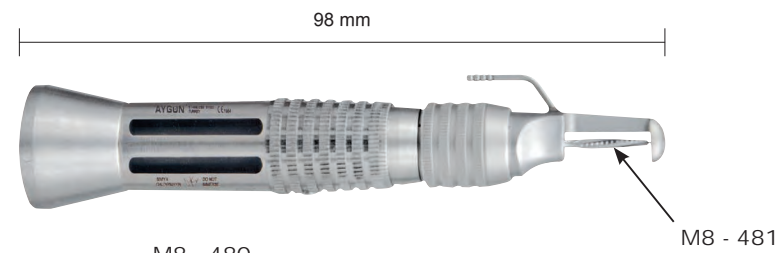

M8 - 480
FREIBURG Craniotome for children
With bone cutter M8-481

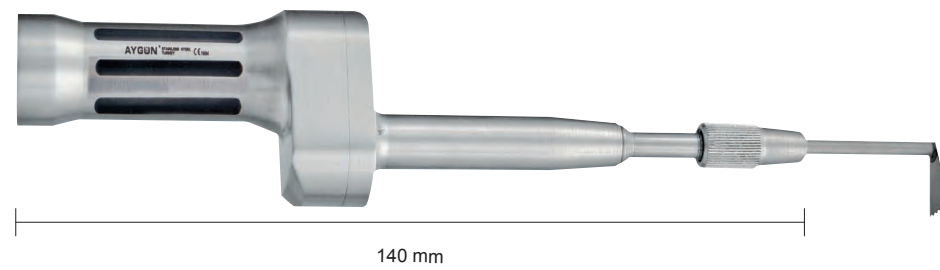

M8 - 120
Micro oscillating saw
Possibility to use extra thin
blades for precision operations.
Narrow design for good visibility.
Saw blades have to be ordered separately

FOR M8-120

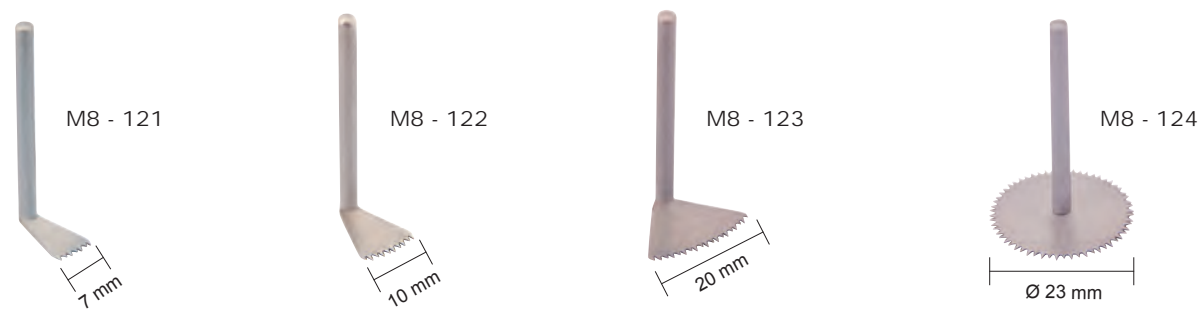

MICRO SAGITTAL ATTACHMENT

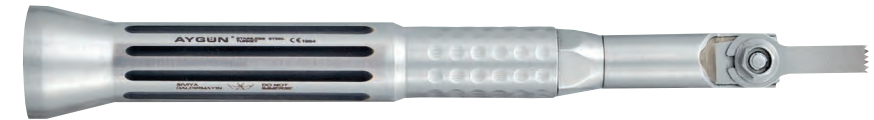

M8 - 1105
Micro Sagittal Saw, pencil grip shape, with unloosable nut

SAGITTAL SAW				FOR M8-1105
Code	Illustration 1:1	Usable Length (mm)	Width (mm)	
M8 - 1120		10	13.4	
M8 - 1121		9	13.0	
M8 - 1122		15	5.0	
M8 - 1123		20	5.0	
M8 - 1124		15	12.0	
M8 - 1125		20	16.0	
M8 - 1126		25	5.0	
M8 - 1127		20	12.0	

CRANIOTOME

MICRO STRAIGHT RECIPROCATING ATTACHMENT



M8 - 728
Craniotome hand piece
for skull opening
no key is needed
with M7-207

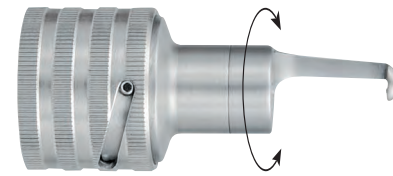

M7 - 208
Dura guard, turnable
use with M8-728



M7 - 207
Dura guard, fixed
use with M8-728

M7 - 201
Spare Cutter
use with M8-728



M7 - 202
Wire pass drill
use with M7-200



Ø 2 mm, L=20 mm



137 mm

M8 - 190
Micro straight reciprocating saw
Without saw blades.
With spray nozzle M8-198
Oscillations per second: 160(at 20.000 rpm)
Height of stroke: 2 mm



M8 - 198
Spray nozzle for M8-190

RECIPROCATING SAW

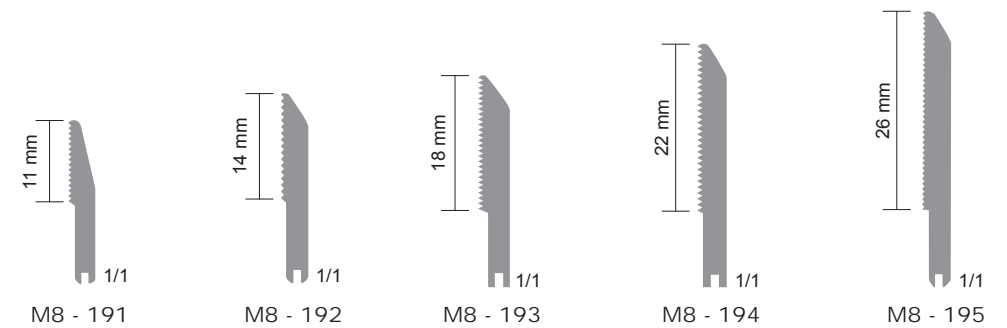

DRILL ATTACHMENT

MICRO DRILL



M8 - 470
Micro Drill
for burrs and drills. Ø 4 mm
Transmission: 20:1



M8 - 471
Micro Drill
for burrs and drills.
For exchangeable chucks
Transmission: 20:1
Suitable chucks: M8-472, M8-474, M8-477

 Twist drill, with round shaft		
Code	Ø Diameter mm	L Length mm
M7 - 500	1.5	60
M7 - 501	2.0	100
M7 - 502	2.5	100
M7 - 503	2.7	100
M7 - 504	3.0	100
M7 - 505	3.2	100
M7 - 506	3.5	100
M7 - 507	4.0	110
M7 - 508	4.5	130
M7 - 509	5.0	160
M7 - 510	6.0	160

FOR M8-470 / M8-471



M8 - 477
HUDSON chuck,
for trepans



M8 - 472
Universal chuck
with key M8-473
max. Ø 4 mm



M8 - 473 Key



M8 - 474
Universal chuck
with key M7-250
max. Ø 6.35 mm



M7 - 250 Key



M7 - 251 Key



M8 - 476
Spray nozzle with clamp



















SHAVER
ARTROSCOPIC SYSTEM

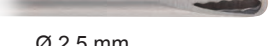

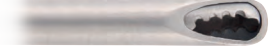
M8 - 940
Shaver Hand Piece
Variable suction control
Connecting to disposable and reusable tips
(the tips are ordered separately)



Round Burr	 M8 - 952 Ø 3.0 mm	Cartilage Trimmer	 M8 - 960 Ø 4.5 mm
	 M8 - 953 Ø 4.5 mm		
Round Surface Burr	 M8 - 954 Ø 6.0 mm	Full Radius resector	 M8 - 961 Ø 2.5 mm
Conical Surface Burr	 M8 - 955 Ø 6.0 mm		 M8 - 962 Ø 4.5 mm
	 M8 - 956 Ø 6.0 mm		 M8 - 963 Ø 6.0 mm
Lateral Cutter	 M8 - 957 Ø 2.5 mm	Full Radius Toothed Resector	 M8 - 964 Ø 2.5 mm
Bilateral Cutter	 M8 - 958 Ø 4.5 mm		 M8 - 965 Ø 4.5 mm
	 M8 - 959 Ø 4.5 mm		 M8 - 966 Ø 6.0 mm
		Ellipsoid Resector	 M8 - 967 Ø 4.5 mm

MICRO OSCILLATING ATTACHMENT

OSCILLATING SAW

OSCILLATING SAW BLADES

FOR M8-133

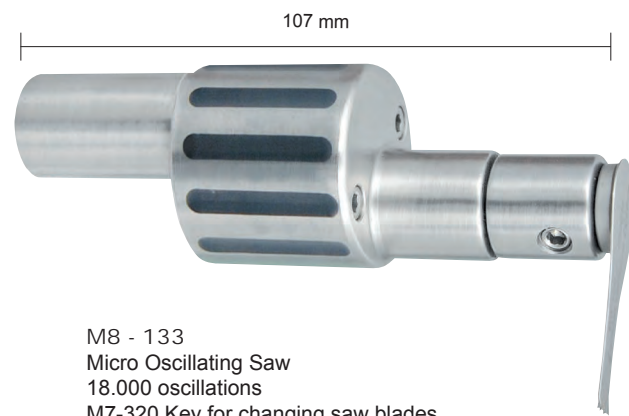

M8 - 133
Micro Oscillating Saw
18.000 oscillations
M7-320 Key for changing saw blades
Saw blades have to be ordered seperately.

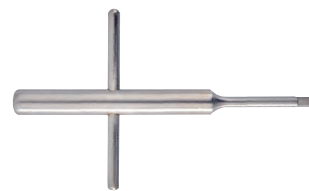

M7 - 320
Key only,
for changing
saw blades



M8 - 501
Spray nozzle with clamp

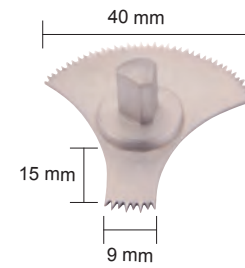

M8 - 134



M8 - 135



M8 - 136



M8 - 137

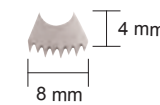

M8 - 139

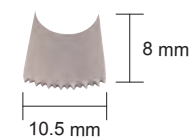

M8 - 140

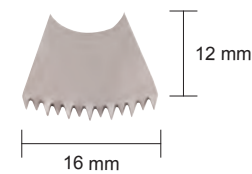

M8 - 141

SMALL SAGITTAL ATTACHMENT

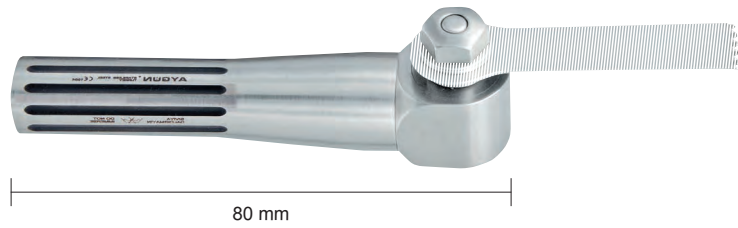

M8 - 275
Small Sagittal Saw
with key M8-282 for exchanging
saw blades.
Saw blades have to be ordered seperately.



M8 - 282
Pair of wrenches,
for changing saw blades



M8 - 276
Spray nozzle with clamp

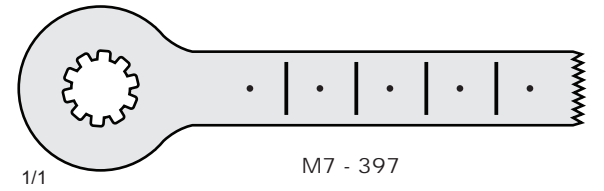
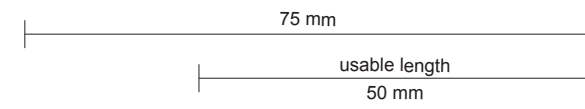

1/1

M7 - 397



1/1

M7 - 396



1/1

M7 - 395



1/1

M7 - 394



1/1

M7 - 398

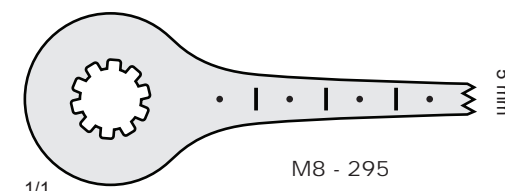
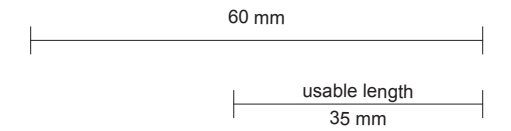

1/1

M8 - 295

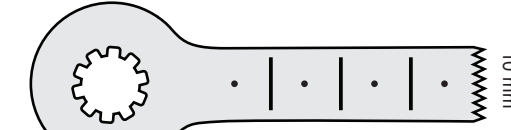

1/1

M8 - 296



1/1

M8 - 297

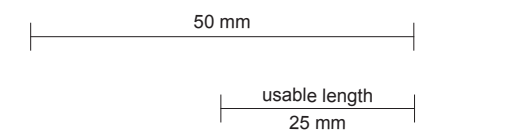

1/1

M8 - 290

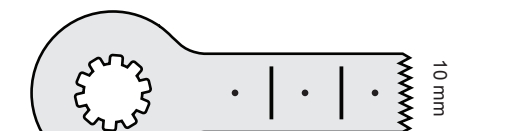

1/1

M8 - 291

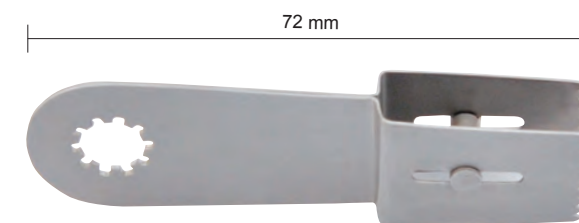

height

CASPAR

- M8 - 313 6 mm height
- M8 - 314 7 mm height
- M8 - 315 8 mm height
- M8 - 316 9 mm height
- M8 - 317 10 mm height
- M8 - 318 11 mm height
- M8 - 319 12 mm height

DRILL RW/FW

BORE MAIN PIECE FOR EXCHANGEABLE
CHUCK WITH FORWARD AND REVERSE GEAR



M8 - 720
Drill
Main piece with forward and reverse gear
Cannulated, Ø 2.5 mm
Without chuck,
Suitable for drilling
Thread cutting
Screwing-in and removing bone
Screws as well as for wire extension.
up to 900 rpm



M7 - 670
Spray nozzle with clamp



M7 - 680
Attachment with small three - jaw chuck, with key M8-473, Ø 4 mm,
exchangeable, use with M8-720



M7 - 681
Attachment with three - jaw chuck, with key M7-250, Ø 6.35 mm,
exchangeable, use with M8-720

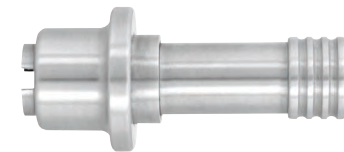

M7 - 682
Adaptor for SQUARE shank
use with M8-720

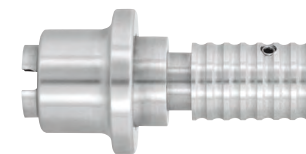

M7 - 683
Adaptor for AO shank
use with M8-720



M7 - 684
Adaptor for TRINKE shank
use with M8-720



M7 - 685
Adaptor for OSTEO shank
use with M8-720



MINI DRILL ATTACHMENT

BURRS-SHANK

70 MM LONG, SHANK Ø 2.35 MM, ROUND SHANK



1/1

M12 - 300
Mini Drill
No key is needed
Only use with pneumatic system

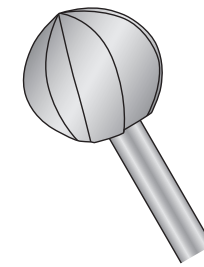

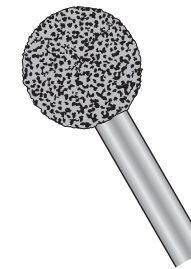

ROSEN
Stainless steel

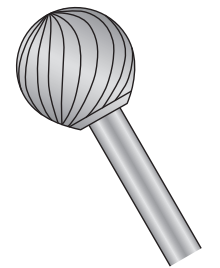

DIAMOND



HIGH SPEED
Tungsten

	1.4	1.8	2.3	2.7	3.1	3.5	4.0	4.5	5.0	6.0	7.0
 ROSEN	M8-1520	M8-1521	M8-1522	M8-1523	M8-1524	M8-1525	M8-1526	M8-1527	M8-1528	M8-1529	M8-1530
 DIAMOND	M8-1550	M8-1551	M8-1552	M8-1553	M8-1554	M8-1555	M8-1556	M8-1557	M8-1558	M8-1559	M8-1560
 HIGH SPEED	M8-1570	M8-1571	M8-1572	M8-1573	M8-1574	M8-1575	M8-1576	M8-1577	M8-1578	M8-1579	M8-1580

MINI OSCILLATING ATTACHMENT

OSCILLATING SAW

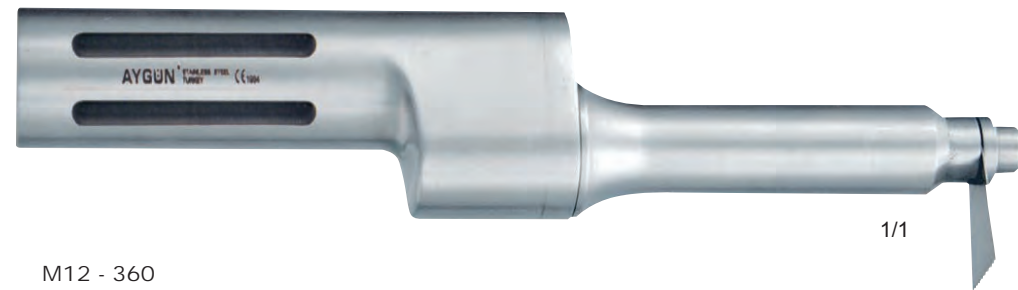

1/1

M12 - 360
Micro Oscillating saw
Oscillating degree is 7°
The cutting blade is replaced by using M7-320 Key
Only use with pneumatic system
See page 37 for spare cutters
with keys M7-320

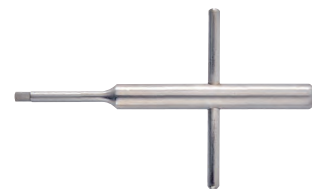

M7 - 320
Key only,
for changing
saw blades

- | | | | |
|-----------|-----|-----------|-----|
| M8 - 1220 | 1/1 | M8 - 1230 | 1/1 |
| M8 - 1221 | 1/1 | M8 - 1231 | 1/1 |
| M8 - 1222 | 1/1 | M8 - 1232 | 1/1 |
| M8 - 1223 | 1/1 | M8 - 1233 | 1/1 |
| M8 - 1224 | 1/1 | M8 - 1234 | 1/1 |
| M8 - 1225 | 1/1 | M8 - 1235 | 1/1 |
| M8 - 1226 | 1/1 | M8 - 1236 | 1/1 |
| M8 - 1227 | 1/1 | M8 - 1237 | 1/1 |
| M8 - 1228 | 1/1 | | |
| M8 - 1229 | 1/1 | | |

MINI SAGITTAL ATTACHMENT
SAGITTAL SAW

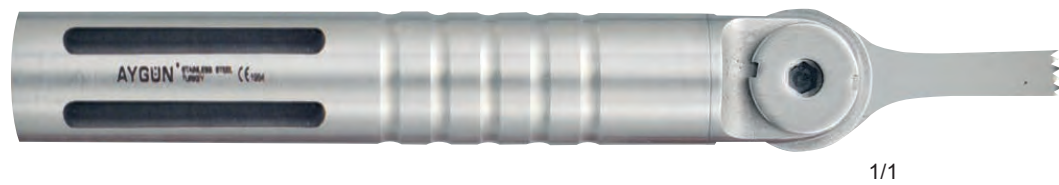

M12 - 380
Mini Sagittal saw
It is used in deep cutting the bones and other small bones in the mandibular and maxillofacial surgery.
The cutting blade is replaced by key
Only use with pneumatic system
See page 39 for spare cutters with keys M7-320

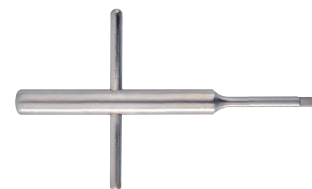

M7 - 320
Key only,
for changing
saw blades

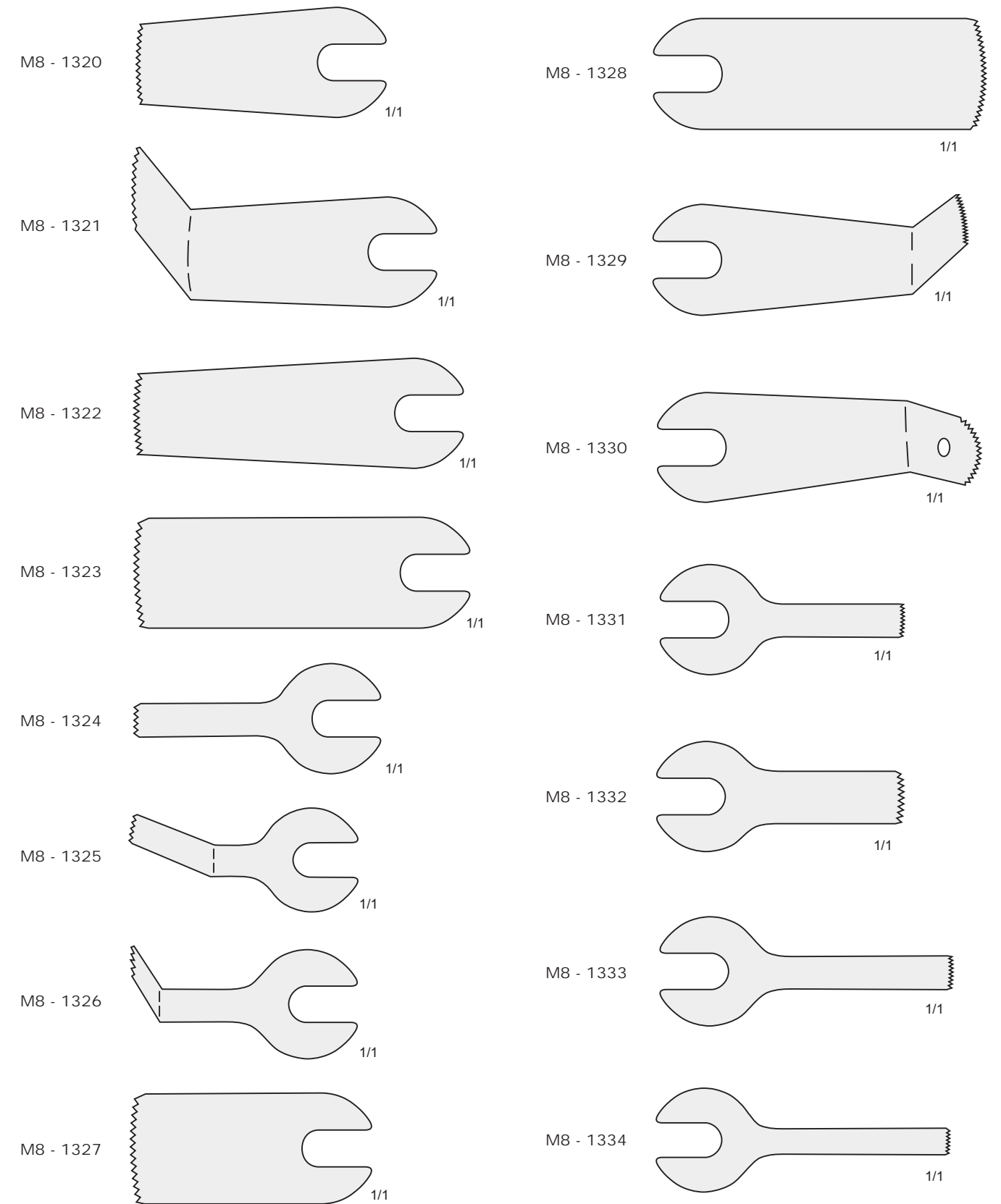



MINI STRAIGHT RECIPROCATING ATTACHMENT
RECIPROCATING SAW

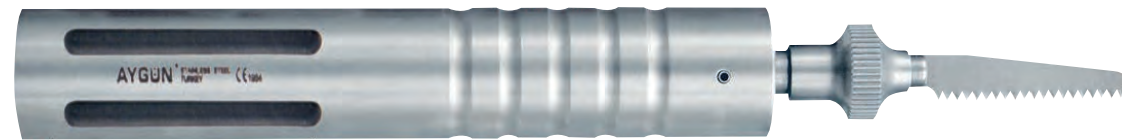

1/1

M12 - 423
Straight reciprocating saw
It is used in deep cutting the bones and other small bones in the mandibular and maxillofacial surgery.
No need for key to replace the blades
Only use with pneumatic system 1
See page 41 for spare cutters

- M8 - 1420 1/1
- M8 - 1421 1/1
- M8 - 1422 1/1
- M8 - 1423 1/1
- M8 - 1424 1/1
- M8 - 1425 1/1
- M8 - 1426 1/1
- M8 - 1427 1/1
- M8 - 1428 1/1
- M8 - 1429 1/1
- M8 - 1430 1/1
- M8 - 1431 1/1
- M8 - 1432 1/1
- M8 - 1433 1/1



WIRE DRIVER
FOR FIXATING SMALL BONES

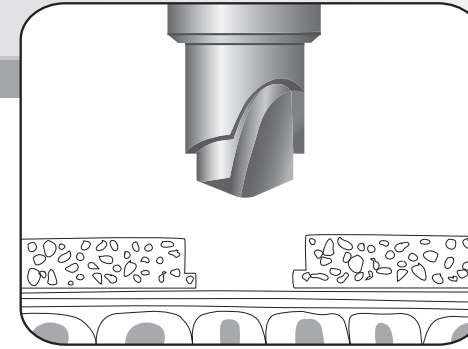

MMS PERFORATOR DRIVE



M12 - 433
K - Wire Driver
for fixating small bones
Ø 0.6 mm - 1.6 mm
Cannulated

1/1



M12 - 201
MMS Perforator Drive,
Used with M9-250, M9-251, M9-252 trepans

SKULL TREPANS

USE WITH M12-201



M9 - 250 Ø 6/9 mm



M9 - 251 Ø 9/12 mm



M9 - 252 Ø 12/15 mm

- * Skull trepans
- * With step-down drilling
- * Automatic cut-out
- * No key needed

DERMATOME



Power System

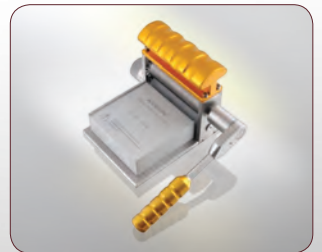

DERMATOME & Skin Graft Mesher
BES Battery + Electro Surgical Motor Systems



For Skin Transplantation

DERMATOME & Skin Graft Mesher
 BES Battery + Electro Surgical Motor Systems

BATTERY POWERED

1 M10-100 Dermatomy handpiece

2 M14-1200 Dermatomy Handpiece

3 M14-1100 Mini Dermatomy Handpiece

POWER CONSOLE USE



M10-100 dermatome handpiece can be operated both with battery and power cord



M14-1200 dermatome handpiece and M14-1100 mini dermatome handpiece can be operated with electric power console and pneumatic system.

CORDED USE

SKIN GRAFT MESHER

Skin graft mesher completes a full set that is sufficient for a skin transplantation operation.

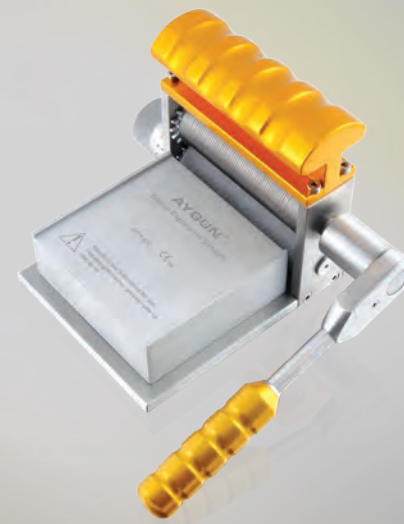

PNEUMATIC USE

DERMATOME BATTERY

FOR SKIN TRANSPLANTATION



- M10 - 103**
Charger unit for 2 battery
(without battery)
- Mains voltage 100-240 Volts, 50-60 Hz, 0.9 A
 - Charging current 1.5 A
 - Charging voltage 9.6 Volts
 - Protections: Short circuit / Overload / Over voltage
 - Dimensions: 200 x 200 x 119 mm
 - Weight: 2850 g



→ Cutting speed adjust button with safe lock.

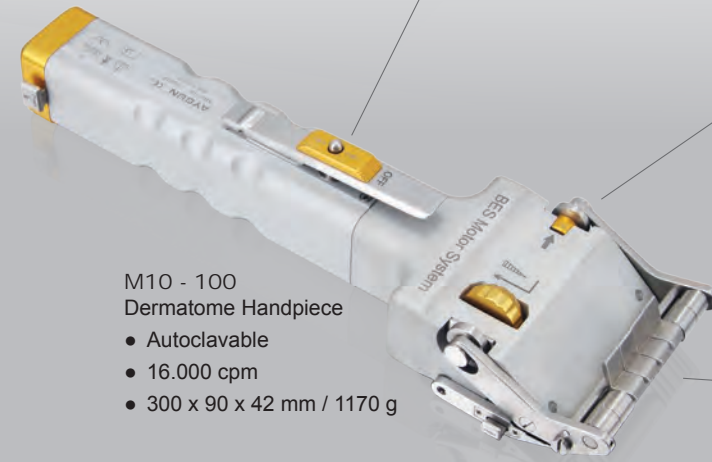

- M10 - 100**
Dermatome Handpiece
- Autoclavable
 - 16.000 cpm
 - 300 x 90 x 42 mm / 1170 g



Dermatome Cutting Thickness		
level	mm	inch
1	0.17	0.006
2	0.34	0.013
3	0.51	0.020
4	0.68	0.026
5	0.85	0.033
6	1.02	0.040
7	1.19	0.046



- M7 - 105**
Spare blades
One side cutting only,
stainless steel
- 10 ea.
 - 81 x 18,5 x 0,40 mm



- M10 - 102**
Rechargeable Ni-MH battery
- Not autoclavable
 - Battery capacity: 1.6 Ah
 - Voltage: 9.6 Volts
 - 136 x 32 x 32 mm / 270 g

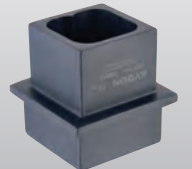

- M10 - 104**
Autoclavable sterile funnel
for aseptic battery loading
- 55 x 55 x 55 mm / 60 g

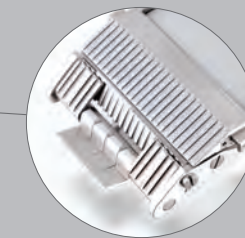

→ 8 flaps give the ability to adjust cutting width from 9.75 mm to 78 mm.



M10 - 101	Dermatome Battery Set
M10-100	Dermatome Handpiece
M10-102	Rechargeable battery
M10-103	Charger Unit
M10-104	Battery loading case
M7-105	Spare blades x10 ea.
K6-247B	Sterile Container
M10-130	Basket with stand
K2-740	Paper filter x100 pcs
K2-660	Security seal x100 pcs
K2-672	Paper labels x100 pcs
K2-673	Paper labels x100 pcs



- User friendly, battery powered high torque motor design.
- No need to connect electric supply or compressed air.
- Removable special batteries make steam sterilization possible.
- Ergonomic and weight balanced design make it easy to handle.
- 8 flaps give the ability to adjust cutting width from 9.75 mm to 78 mm.
- Easy blade change mechanism designed to insert the blade only one side thus uncorrect blade insertion is avoided.
- Cutting speed can be adjusted by only one finger.
- Safe lock mechanism prevents from unwanted operation of the motor.

SET FOR STERILIZATION

- K2 - 740**
Single use paper filter 100 pcs with indicator. Aygun mark.



- K2 - 673**
Labels, paper x 100 pcs With indicator.



- M10 - 130**
Basket with stand 405 x 253 x 70 mm

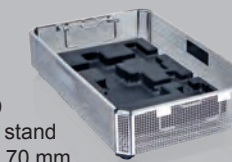

- K2 - 672**
Labels, paper x 100 pcs With indicator.



- K6 - 247B**
Sterile Container 481 x 280 x 135 mm



- K2 - 660**
Security seal made of plastic 100 pcs



DERMATOME ELECTRO
FOR SKIN TRANSPLANTATION



- M10 - 112**
Power supply for direct corded use
- Mains voltage 100-240 Volts, 50-60 Hz
 - Supply voltage 15 Volts, current 4A
 - Protections: Short circuit / Overload / Over voltage
 - Dimensions: 140 x 128 x 89 mm
 - Weight: 560 g

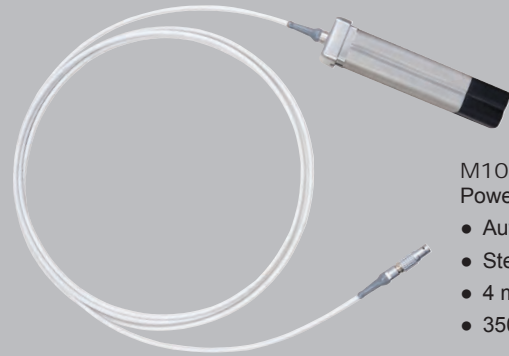

- M10 - 113**
Power cord for direct corded use
- Autoclavable,
 - Steam sterilisable at 2 bar 134° C
 - 4 m. cable length
 - 350 g



→ Cutting speed adjust button with safe lock.

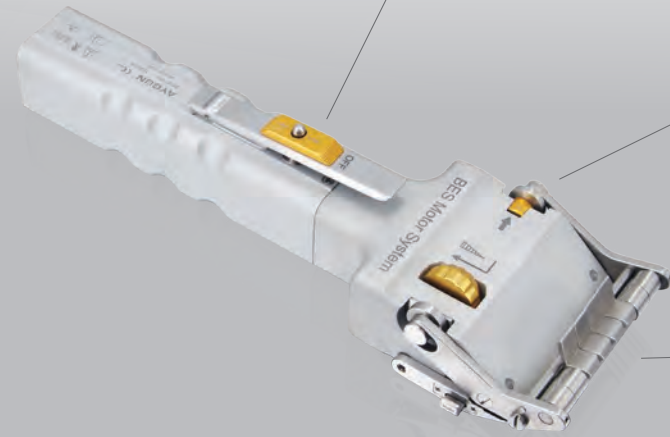

- M10 - 110**
Dermatome Handpiece
- Autoclavable
 - 16.000 cpm
 - 283 x 90 x 42 mm / 1080 g



→ 8 flaps give the ability to adjust cutting width from 9.75 mm to 78 mm.

Dermatome Cutting Thickness		
level	mm	inch
1	0.17	0.006
2	0.34	0.013
3	0.51	0.020
4	0.68	0.026
5	0.85	0.033
6	1.02	0.040
7	1.19	0.046



- M7 - 105**
Spare blades
One side cutting only.
stainless steel
- 10 ea.
 - 81 x 18,5 x 0,40 mm

M10 - 111	Dermatome Electro Set
M10-110	Dermatome Handpiece
M10-112	Power Supply
M10-113	Fixing socket with cable
M7-105	Spare blades x10 ea.
K6-247B	Sterile Container
M10-130	Basket with stand
K2-740	Paper filter x100 pcs
K2-660	Security seal x100 pcs
K2-672	Paper labels x100 pcs
K2-673	Paper labels x100 pcs



SET FOR STERILIZATION

- K2 - 740**
Single use paper filter 100 pcs with indicator. Aygün mark.



- K2 - 673**
Labels, paper x 100 pcs With indicator.



- M10 - 130**
Basket with stand 405 x 253 x 70 mm

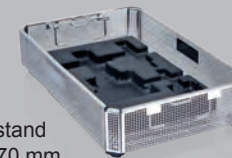

- K2 - 672**
Labels, paper x 100 pcs With indicator.



- K6 - 247B**
Sterile Container 481 x 280 x 135 mm



- K2 - 660**
Security seal made of plastic 100 pcs



DERMATOME BATTERY & ELECTRO
FOR SKIN TRANSPLANTATION



- M10 - 105**
Power supply and Charger unit for 2 battery (without battery)
- Can charge batteries and supply power for corded operation at the same time.
 - Mains voltage 100-240 Volts, 50-60 Hz, 1.5 A
 - Charging current 1.5 A
 - Charging voltage 9.6 Volts
 - Power supply 15 Volts, 4 A
 - Protections: Short circuit / Overload / Over voltage
 - Dimensions: 230 x 230 x 119 mm
 - Weight: 3210 g



→ Cutting speed adjust button with safe lock.

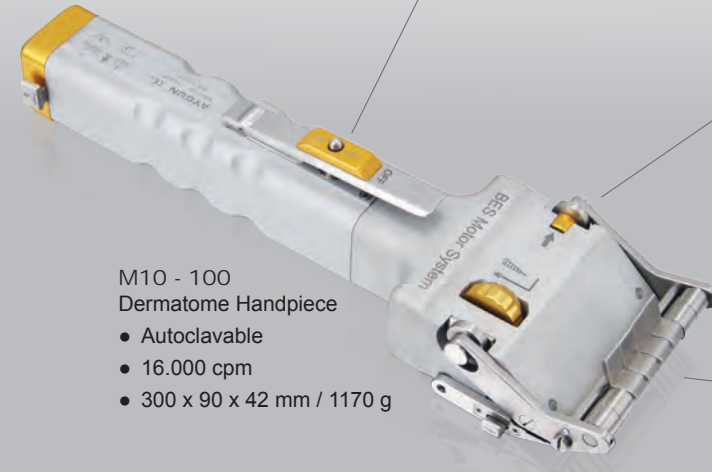

- M10 - 100**
Dermatome Handpiece
- Autoclavable
 - 16.000 cpm
 - 300 x 90 x 42 mm / 1170 g



Dermatome Cutting Thickness		
level	mm	inch
1	0.17	0.006
2	0.34	0.013
3	0.51	0.020
4	0.68	0.026
5	0.85	0.033
6	1.02	0.040
7	1.19	0.046



- M7 - 105**
Spare blades
One side cutting only, stainless steel
- 10 ea.
 - 81 x 18,5 x 0,40 mm



- M10 - 102**
Rechargeable Ni-MH battery
- Not autoclavable
 - Battery capacity: 1.6 Ah
 - Voltage: 9.6 Volts
 - 136 x 32 x 32 mm / 270 g

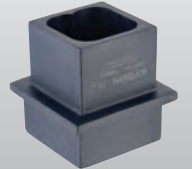

- M10 - 104**
Autoclavable sterile funnel for aseptic battery loading
- 55 x 55 x55 mm / 60 g

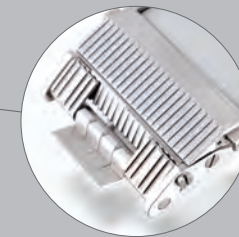

→ 8 flaps give the ability to adjust cutting width from 9.75 mm to 78 mm.

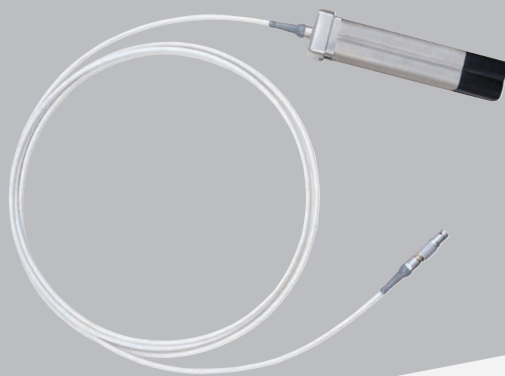

- M10 - 113**
Power cord for direct corded use
- Autoclavable,
 - Steam sterilisable at 2 bar 134° C
 - 4 m. cable length
 - 350 g

M10 - 121	Dermatome Battery Set
M10-100	Dermatome Handpiece
M10-102	Rechargeable battery
M10-105	Charger Unit
M10-104	Battery loading case
M10-113	Fixing socket with cable
M7-105	Spare blades x10 ea.
K6-247B	Sterile Container
M10-130	Basket with stand
K2-740	Paper filter x100 pcs
K2-660	Security seal x100 pcs
K2-672	Paper labels x100 pcs
K2-673	Paper labels x100 pcs

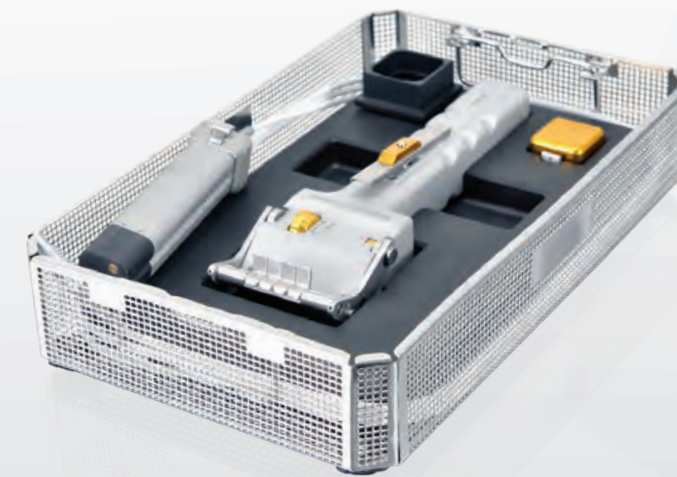

- M10 - 130**
Basket with stand
405 x 253 x 70 mm



- K6 - 247B**
Sterile Container
481 x 280 x 135 mm

SET FOR STERILIZATION

- K2 - 740**
Single use paper filter 100 pcs with indicator. Aygun mark.

- K2 - 673**
Labels, paper x 100 pcs With indicator.

- K2 - 672**
Labels, paper x 100 pcs With indicator.

- K2 - 660**
Security seal made of plastic 100 pcs

DERMATOME ELECTRO
FOR SKIN TRANSPLANTATION



M14 - 700
Power console

- Operating Speed: 40.000 rpm (Adjustable Maximum Speed)
- Operating Voltage: 200-240 V
- Power: 260 W
- Irrigation Flow Rate: 100 ml/min (Adjustable Maximum Flow Rate)
- Frequency : 50-60 Hz
- Dimensions: 350x280x110 mm
- Weight : 5.060 kg

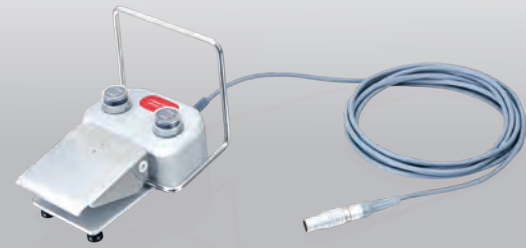

M6 - 054
Foot pedal, with irrigation and F/R buttons

- Cable Length: 4 m
- Dimensions: 200x155x150 mm
- Weight: 1.560 kg



M14 - 310
Motor Cable

- Autoclavable
- Cable length: 4 m
- Weight: 490 g



M14 - 800
Swiss Made
Powerful Brushless
DC Motor Technology

- Autoclavable
- Operating Speed: 40.000 rpm (Adjustable Maximum Speed)
- Power: 150 W
- Dimensions: 130x22 mm
- Weight: 0.160 kg

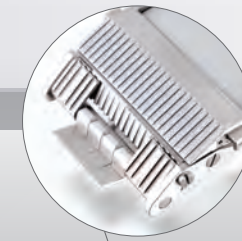

8 flaps gives the ability to adjust cutting width from 9.75 mm to 78 mm.



M14 - 1200
Dermatome Handpiece
(With M14-800 max: 20.000 rpm)

- Autoclavable
- 200 x 90 x 42 mm / 960 g



Dermatome Cutting Thickness		
level	mm	inch
1	0.17	0.006
2	0.34	0.013
3	0.51	0.020
4	0.68	0.026
5	0.85	0.033
6	1.02	0.040
7	1.19	0.046



M7 - 105
Spare blades
One side cutting only.
stainless steel

- 10 ea.
- 81 x 18,5 x 0,40 mm

M14 - 1201	Dermatome Electro Set
M14-1200	Dermatome Handpiece
M6-054	Foot pedal
M14-310	Motor cable
M14-700	Power console
M14-800	Electric motor
M7-105	Spare blades x10 ea.
K6-247B	Sterile Container
M14-1230	Basket with stand
K2-740	Paper filter x100 pcs
K2-660	Security seal x100 pcs
K2-672	Paper labels x100 pcs
K2-673	Paper labels x100 pcs

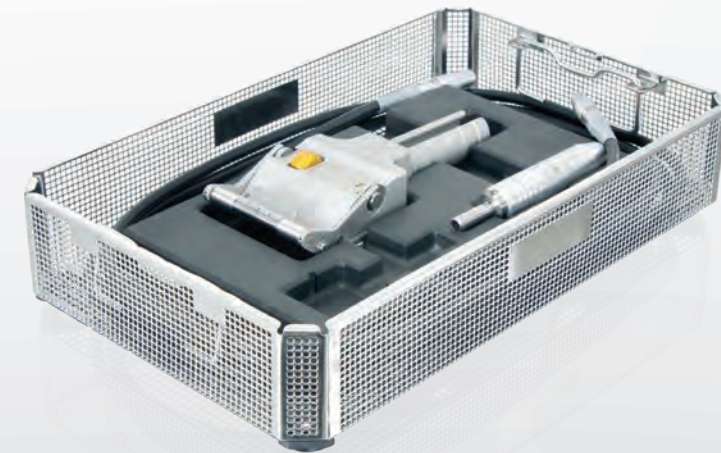

SET FOR STERILIZATION

K2 - 740
Single use paper filter 100 pcs with indicator. Aygün mark.



K2 - 673
Labels, paper x 100 pcs With indicator.



M14 - 1230
Basket with stand 405 x 253 x 70 mm

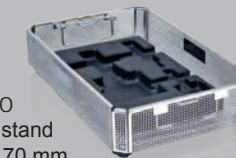

K2 - 672
Labels, paper x 100 pcs With indicator.



K6 - 247B
Sterile Container 481 x 280 x 135 mm



K2 - 660
Security seal made of plastic 100 pcs



MINI DERMATOME ELECTRO

FOR SKIN TRANSPLANTATION



M14 - 700
Power console

- Operating Speed: 40.000 rpm (Adjustable Maximum Speed)
- Operating Voltage: 200-240 V
- Power: 260 W
- Irrigation Flow Rate: 100 ml/min (Adjustable Maximum Flow Rate)
- Frequency : 50-60 Hz
- Dimensions: 350x280x110 mm
- Weight : 5.060 kg

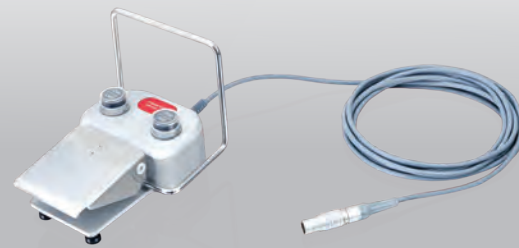

M6 - 054
Foot pedal, with irrigation and F/R buttons

- Cable Length: 4 m
- Dimensions: 200x155x150 mm
- Weight: 1.560 kg



M14 - 310
Motor Cable

- Autoclavable
- Cable length: 4 m
- Weight: 490 g



M14 - 800
Swiss Made
Powerful Brushless
DC Motor Technology

- Autoclavable
- Operating Speed: 40.000 rpm (Adjustable Maximum Speed)
- Power: 150 W
- Dimensions: 130x22 mm
- Weight: 0.160 kg

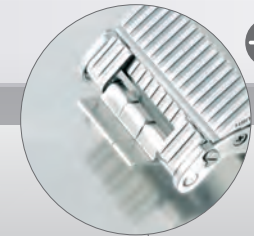

5 flaps gives the ability to adjust cutting width from 8 mm to 40 mm.



M14 - 1100
Mini Dermatome Handpiece
(With M14-800 max: 20.000 rpm)

- Autoclavable
- 110 x 50 x 27 mm / 180 g

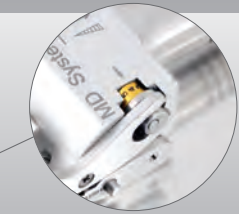

Dermatome Cutting Thickness		
level	mm	inch
1	0.17	0.006
2	0.34	0.013
3	0.51	0.020
4	0.68	0.026
5	0.85	0.033
6	1.02	0.040



M14 - 1105
Spare blades
One side cutting only.
stainless steel

- 10 ea.
- 43 x 9 x 0,40 mm

M14 - 1101	Dermatome Mini Electro Set
M14-1100	Mini Dermatome Handpiece
M6-054	Foot pedal
M14-310	Motor cable
M14-700	Power console
M14-800	Electric motor
M14-1105	Spare blades x10 ea.
K6-247B	Sterile Container
K3-750	Basket
K2-524	Silicone mat
K2-740	Paper filter x100 pcs
K2-660	Security seal x100 pcs
K2-672	Paper labels x100 pcs
K2-673	Paper labels x100 pcs



MINI Dermatome

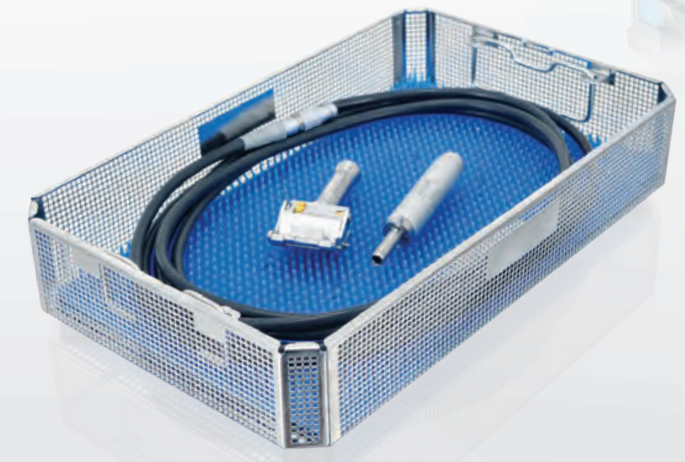

SET FOR STERILIZATION

K2 - 524
Silicone mat
380 x 230 mm

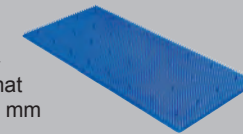

K3 - 750
Basket
405 x 253 x 70 mm

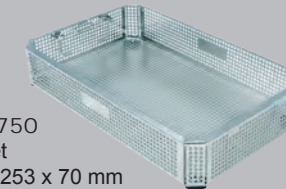

K6 - 247B
Sterile Container
481 x 280 x 135 mm



K2 - 673
Labels, paper x 100 pcs
With indicator.



K2 - 672
Labels, paper x 100 pcs
With indicator.



K2 - 660
Security seal made of
plastic 100 pcs



K2 - 740
Single use paper
filter 100 pcs
with indicator.
Aygun mark.



DERMATOME PNEUMATIC STANDARD

FOR SKIN TRANSPLANTATION



M7 - 230
Air pressure reducer
• 200 x 250 x 77 mm / 2150 g

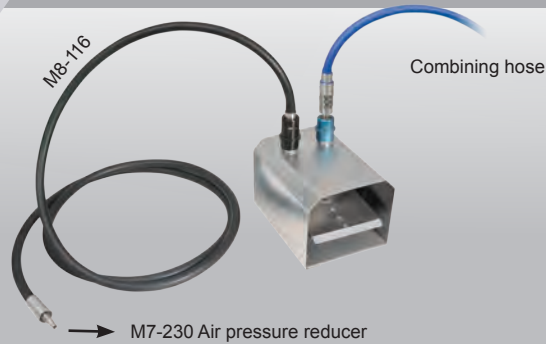

M8 - 114
Foot control pedal, M8-116 without combining hose
• 210 x 190 x 150 mm / 3160 g



M9 - 167 > 3 m
M9 - 168 > 5 m
Combining hoses for air supply
• Autoclavable
• 630 g



M12 - 800
Pneumatic Motor
Max. Working Pressure= 6 bar (90 psi)
• Autoclavable
• 185 x 25 mm / 360 g

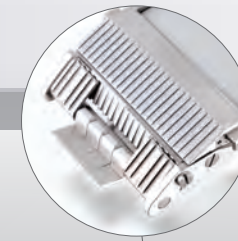

8 flaps give the ability to adjust cutting width from 9.75 mm to 78 mm.

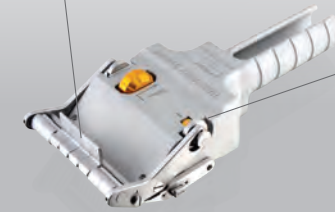

M14 - 1200
Dermatome Handpiece
• Autoclavable
• 200 x 90 x 42 mm / 960 g

Dermatome Cutting Thickness		
level	mm	inch
1	0.17	0.006
2	0.34	0.013
3	0.51	0.020
4	0.68	0.026
5	0.85	0.033
6	1.02	0.040
7	1.19	0.046



M7 - 105
Spare blades
One side cutting only.
stainless steel
• 10 ea.
• 81 x 18,5 x 0,40 mm

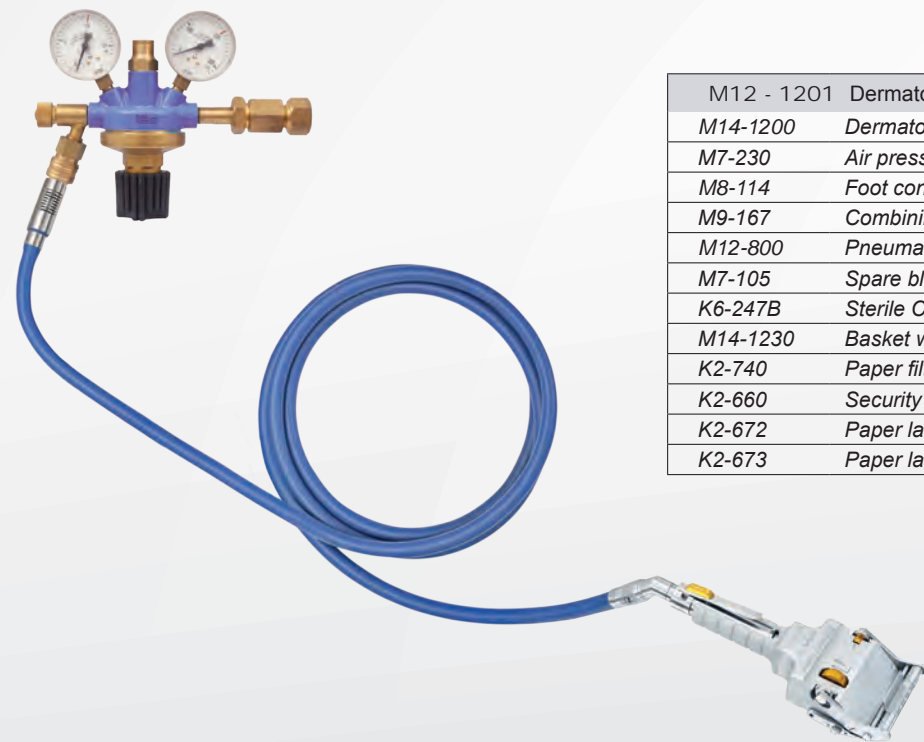

M12 - 1201	Dermatome Pneumatic Set
M14-1200	Dermatome Handpiece
M7-230	Air pressure reducer
M8-114	Foot control pedal
M9-167	Combining hoses for air supply
M12-800	Pneumatic motor
M7-105	Spare blades x10 ea.
K6-247B	Sterile Container
M14-1230	Basket with stand
K2-740	Paper filter x100 pcs
K2-660	Security seal x100 pcs
K2-672	Paper labels x100 pcs
K2-673	Paper labels x100 pcs

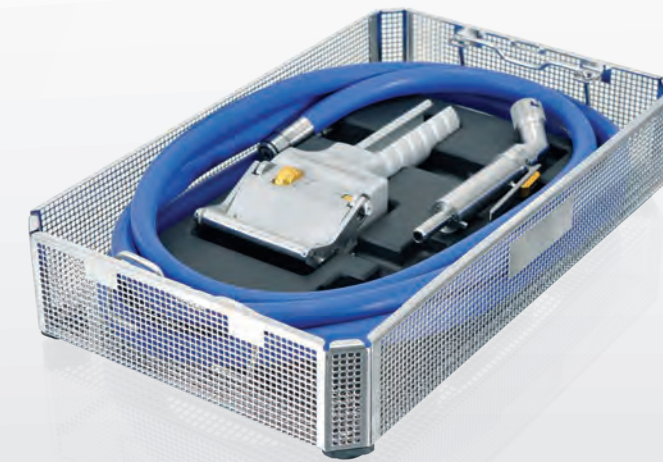

K6 - 247B
Sterile Container
481 x 280 x 135 mm

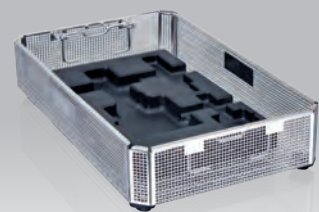

M14 - 1230
Basket with stand
405 x 253 x 70 mm



K2 - 740
Single use paper filter 100 pcs
with indicator. Aygün mark.



K2 - 660
Security seal made of
plastic 100 pcs



K2 - 672
Labels, paper x 100 pcs
With indicator.



K2 - 673
Labels, paper x 100 pcs
With indicator.

MINI DERMATOME PNEUMATIC STANDARD

FOR SKIN TRANSPLANTATION



M7 - 230
Air pressure reducer
• 200 x 250 x 77 mm / 2150 g

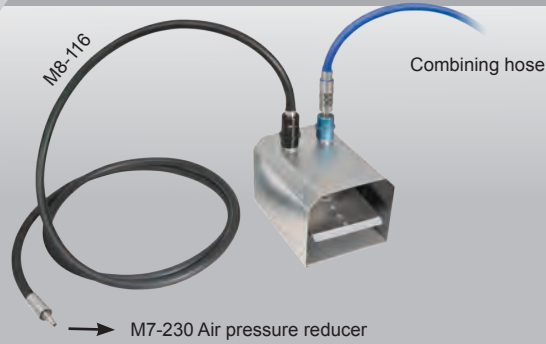

M8 - 114
Foot control pedal, M8-116 without combining hose
• 210 x 190 x 150 mm / 3160 g



M9 - 167 > 3 m
M9 - 168 > 5 m
Combining hoses for air supply
• Autoclavable
• 630 g



M12 - 800
Pneumatic Motor
Max. Working Pressure= 6 bar (90 psi)
• Autoclavable
• 185 x 25 mm / 360 g

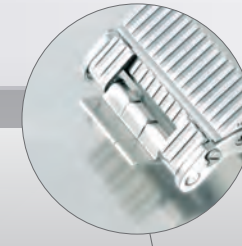

5 flaps give the ability to adjust cutting width from 8 mm to 40 mm.

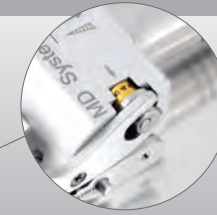

M14 - 1100
Mini Dermatome Handpiece
• Autoclavable
• 110 x 50 x 27 mm / 180 g

Dermatome Cutting Thickness		
level	mm	inch
1	0.17	0.006
2	0.34	0.013
3	0.51	0.020
4	0.68	0.026
5	0.85	0.033
6	1.02	0.040



M14 - 1105
Spare blades
One side cutting only.
stainless steel
• 10 ea.
• 43 x 9 x 0,40 mm

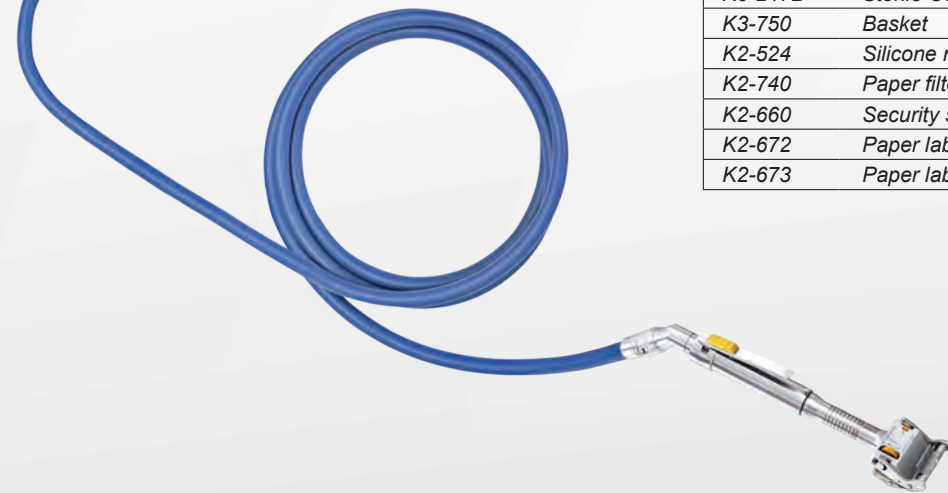

M12 - 1101	Dermatome Mini Pneumatic Set
M14-1100	Mini Dermatome Handpiece
M8-114	Foot control pedal
M9-167	Combining hoses for air supply
M7-230	Air pressure reducer
M14-1105	Spare blades x10 ea.
K6-247B	Sterile Container
K3-750	Basket
K2-524	Silicone mat
K2-740	Paper filter x100 pcs
K2-660	Security seal x100 pcs
K2-672	Paper labels x100 pcs
K2-673	Paper labels x100 pcs

MINI Dermatome



K6 - 247B
Sterile Container
481 x 280 x 135 mm

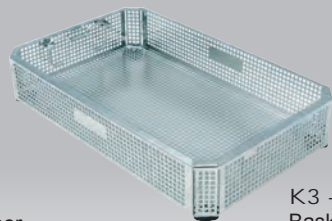

K3 - 750
Basket
405 x 253 x 70 mm

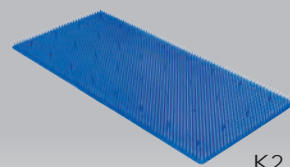

K2 - 524
Silicone mat
380 x 230 mm



K2 - 740
Single use paper filter 100 pcs
with indicator. Aygün mark.



K2 - 660
Security seal made of
plastic 100 pcs



K2 - 672
Labels, paper x 100 pcs
With indicator.



K2 - 673
Labels, paper x 100 pcs
With indicator.

SKIN GRAFT MESHER

FOR SKIN TRANSPLANTATION



■ Guides for Graft Carrier

■ Ratchet Handle for Easy Operation

■ Graft Thickness Adjustment (0-1,5 mm)

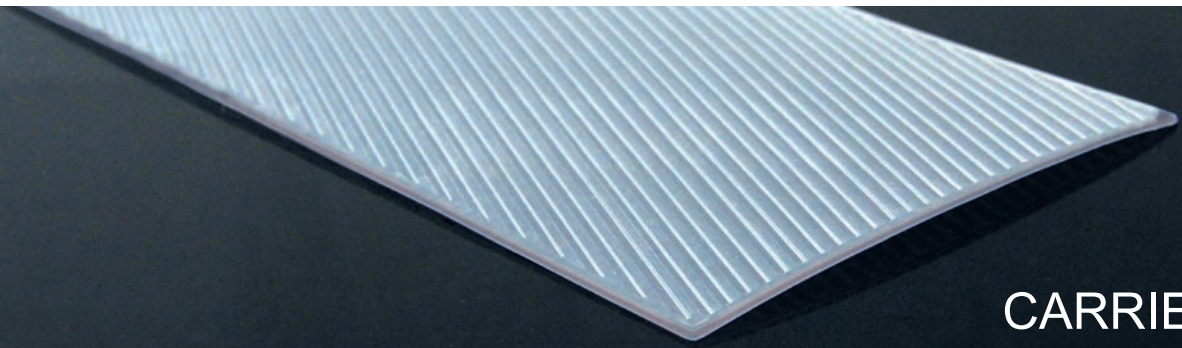

CARRIER



M11 - 500
Skin Graft Mesher
• 205 x 165 x 120 mm / 4000 g

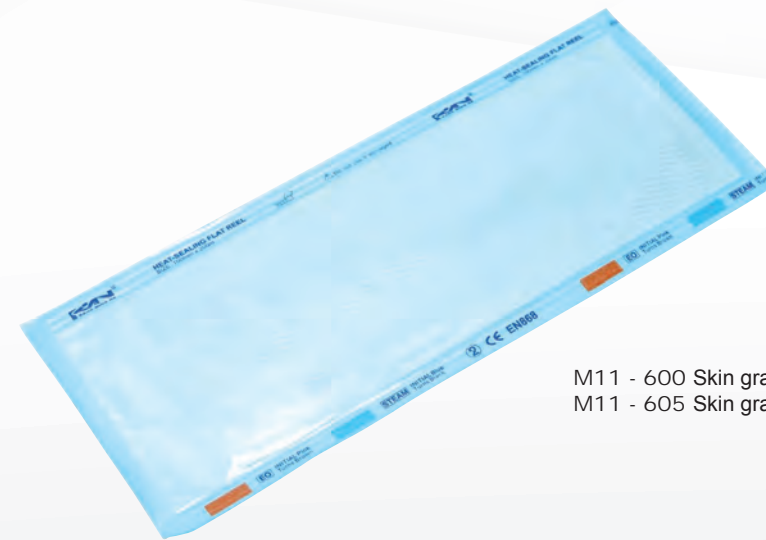

M11 - 600 Skin graft carrier > 1,5:1 (Box of 20)
M11 - 605 Skin graft carrier > 3:1 (Box of 20)

- Single cutter cuts skin graft into geometrical shaped mesh & enlarges skin surface.
- Graft expansion predetermined by graft carrying plates, eliminating need to change the cutter during operation.
- Continuous feed design prevents graft carrying plate from being loaded incorrectly and allows multiple plates to be used without interruption.
- Graft thickness adjustment feature allows expansion on thin and thick grafts.
- Easy availability of replacement parts.

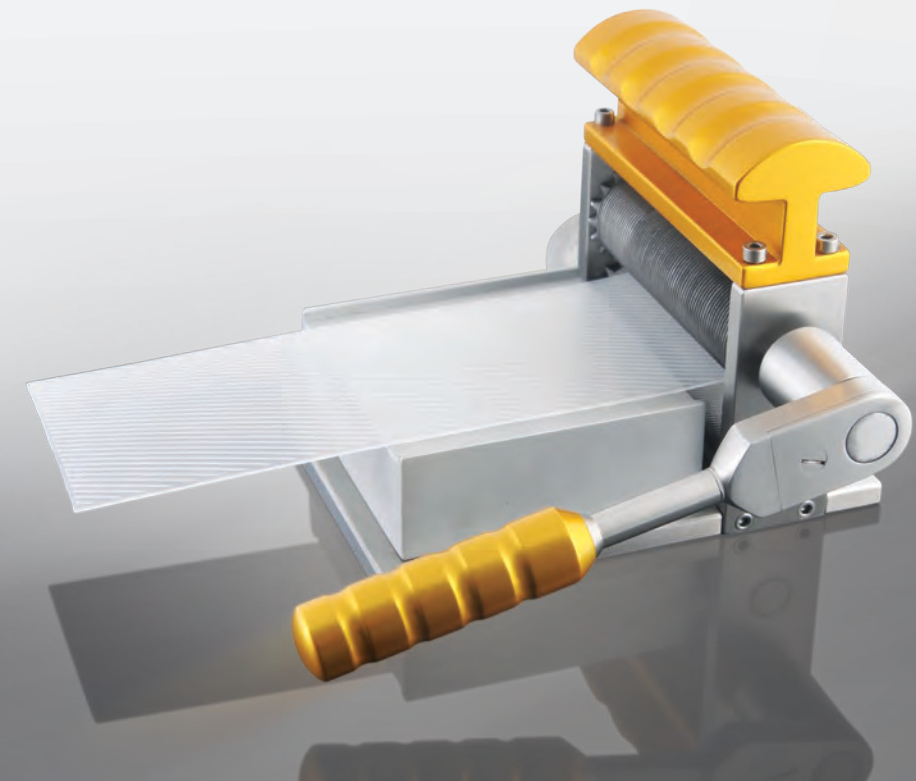

NOTE:

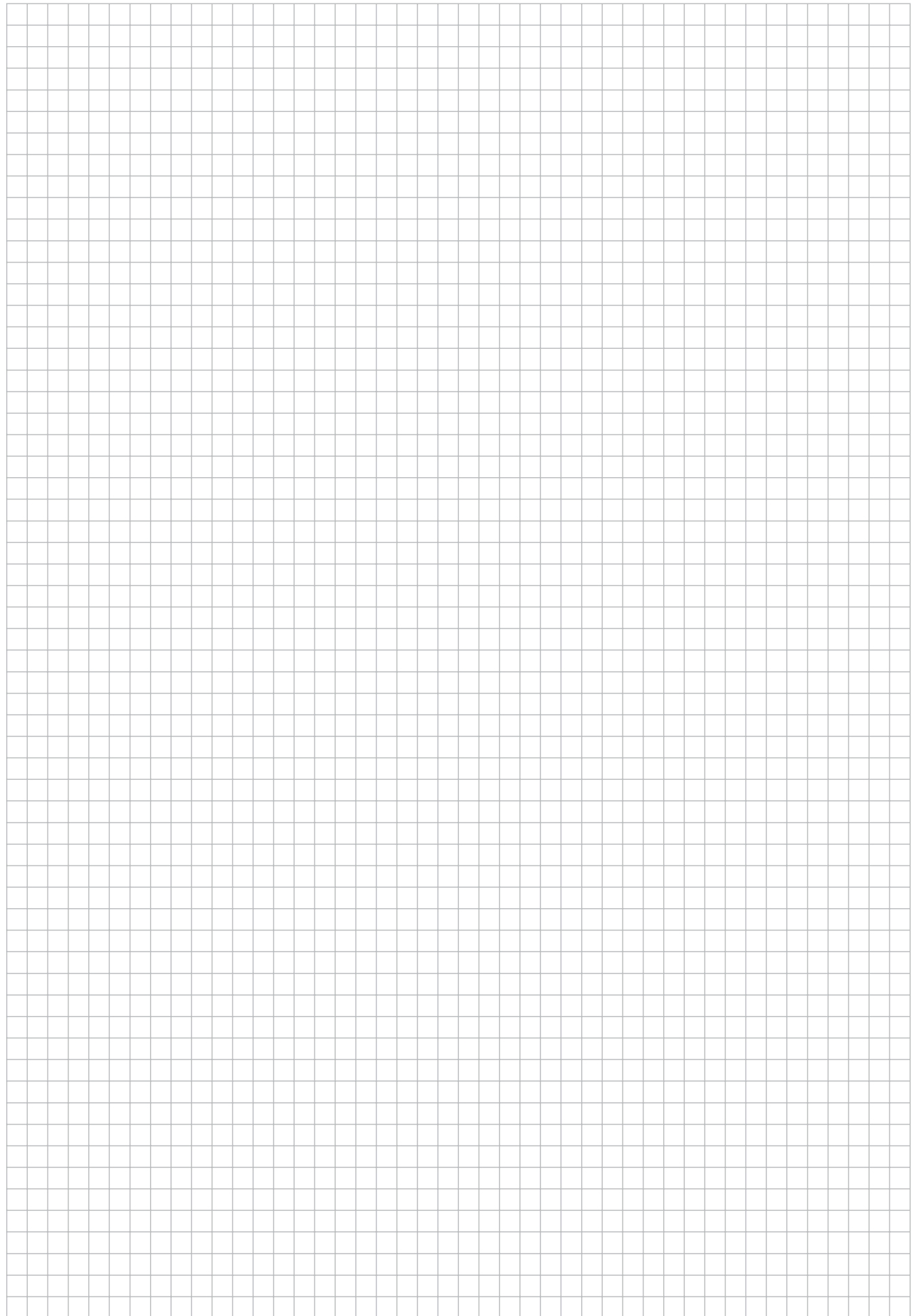

NOTE:

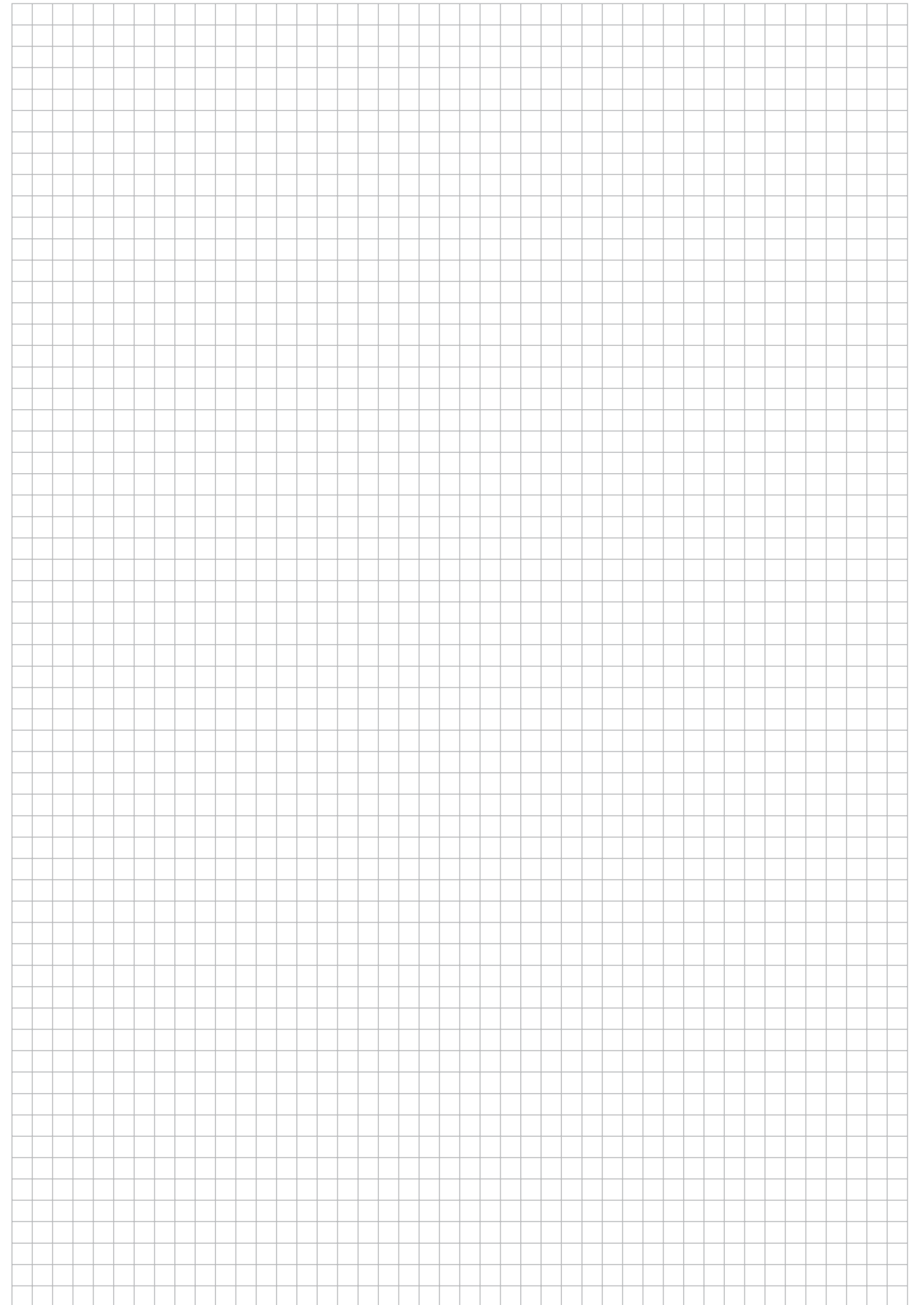



INDEX

Code	On Page	Code	On Page	Code	On Page
K2 - 524	57, 60	M8 - 114	58, 60	M8 - 282	30
K2 - 660	49, 51, 53, 55, 57, 59, 61	M8 - 120	20	M8 - 290	31
K2 - 672	49, 51, 53, 55, 57, 59, 61	M8 - 121	20	M8 - 291	31
K2 - 673	49, 51, 53, 55, 57, 59, 61	M8 - 122	20	M8 - 295	31
K2 - 740	49, 51, 53, 55, 57, 59, 61	M8 - 123	20	M8 - 296	31
K3 - 750	57, 60	M8 - 124	20	M8 - 297	31
K6 - 247B	49, 51, 53, 55, 57, 58, 60	M8 - 133	28	M8 - 300	10
M6 - 054	4, 54, 56	M8 - 134	29	M8 - 302	10
M7 - 105	49, 51, 53, 55, 59	M8 - 135	29	M8 - 304	10
M7 - 201	22	M8 - 136	29	M8 - 306	10
M7 - 202	22	M8 - 137	29	M8 - 308	10
M7 - 207	22	M8 - 139	29	M8 - 310	10
M7 - 208	22	M8 - 140	29	M8 - 312	10
M7 - 230	58, 60	M8 - 141	29	M8 - 313	31
M7 - 250	25	M8 - 150	16	M8 - 314	31
M7 - 251	25	M8 - 151	16	M8 - 315	31
M7 - 320	28, 36, 38	M8 - 152	16	M8 - 316	31
M7 - 394	31	M8 - 160	18	M8 - 317	31
M7 - 395	31	M8 - 170	18	M8 - 318	31
M7 - 396	31	M8 - 180	17	M8 - 319	31
M7 - 397	31	M8 - 181	17	M8 - 320	10
M7 - 398	31	M8 - 182	17	M8 - 322	10
M7 - 500	25	M8 - 183	17	M8 - 324	10
M7 - 501	25	M8 - 184	17	M8 - 326	10
M7 - 502	25	M8 - 185	17	M8 - 328	10
M7 - 503	25	M8 - 190	23	M8 - 330	10
M7 - 504	25	M8 - 191	23	M8 - 332	10
M7 - 505	25	M8 - 192	23	M8 - 334	10
M7 - 506	25	M8 - 193	23	M8 - 340	11
M7 - 507	25	M8 - 194	23	M8 - 342	11
M7 - 508	25	M8 - 195	23	M8 - 344	11
M7 - 509	25	M8 - 198	23	M8 - 346	11
M7 - 510	25	M8 - 201	8	M8 - 348	11
M7 - 670	32	M8 - 202	8	M8 - 350	11
M7 - 680	33	M8 - 203	8	M8 - 352	11
M7 - 681	33	M8 - 210	9	M8 - 354	11
M7 - 682	33	M8 - 211	9	M8 - 381	12
M7 - 683	33	M8 - 212	9	M8 - 383	12
M7 - 684	33	M8 - 275	30	M8 - 385	12
M7 - 685	33	M8 - 276	30	M8 - 386	12

Code	On Page	Code	On Page	Code	On Page
M8 - 391	12	M8 - 470	24	M8 - 958	27
M8 - 393	12	M8 - 471	24	M8 - 959	27
M8 - 395	12	M8 - 472	25	M8 - 960	27
M8 - 396	12	M8 - 473	25	M8 - 961	27
M8 - 397	12	M8 - 474	25	M8 - 962	27
M8 - 401	12	M8 - 476	25	M8 - 963	27
M8 - 403	12	M8 - 477	25	M8 - 964	27
M8 - 405	12	M8 - 480	20	M8 - 965	27
M8 - 406	12	M8 - 481	20	M8 - 966	27
M8 - 407	12	M8 - 485	19	M8 - 967	27
M8 - 410	13	M8 - 486	19	M8 - 1105	21
M8 - 412	13	M8 - 487	19	M8 - 1120	21
M8 - 414	13	M8 - 501	28	M8 - 1121	21
M8 - 416	13	M8 - 550	8	M8 - 1122	21
M8 - 418	13	M8 - 551	8	M8 - 1123	21
M8 - 420	13	M8 - 552	8	M8 - 1124	21
M8 - 422	13	M8 - 553	9	M8 - 1125	21
M8 - 424	13	M8 - 554	9	M8 - 1126	21
M8 - 426	13	M8 - 555	9	M8 - 1127	21
M8 - 428	13	M8 - 556	16	M8 - 1220	37
M8 - 431	14	M8 - 557	16	M8 - 1221	37
M8 - 433	14	M8 - 558	16	M8 - 1222	37
M8 - 434	14	M8 - 580	17	M8 - 1223	37
M8 - 435	14	M8 - 581	17	M8 - 1224	37
M8 - 436	14	M8 - 582	17	M8 - 1225	37
M8 - 441	14	M8 - 583	17	M8 - 1226	37
M8 - 443	14	M8 - 584	17	M8 - 1227	37
M8 - 444	14	M8 - 595	17	M8 - 1228	37
M8 - 445	14	M8 - 596	17	M8 - 1229	37
M8 - 446	14	M8 - 600	17	M8 - 1230	37
M8 - 450	15	M8 - 601	17	M8 - 1231	37
M8 - 452	15	M8 - 720	32	M8 - 1232	37
M8 - 454	15	M8 - 728	22	M8 - 1233	37
M8 - 456	15	M8 - 940	26	M8 - 1234	37
M8 - 458	15	M8 - 952	27	M8 - 1235	37
M8 - 460	15	M8 - 953	27	M8 - 1236	37
M8 - 462	15	M8 - 954	27	M8 - 1237	37
M8 - 464	15	M8 - 955	27	M8 - 1320	39
M8 - 466	15	M8 - 956	27	M8 - 1321	39
M8 - 468	15	M8 - 957	27	M8 - 1322	39



INDEX

Code	On Page	Code	On Page	Code	On Page
M8 - 1323	39	M8-1553	35	M12 - 300	34
M8 - 1324	39	M8-1554	35	M12 - 360	36
M8 - 1325	39	M8-1555	35	M12 - 380	38
M8 - 1326	39	M8-1556	35	M12 - 423	40
M8 - 1327	39	M8-1557	35	M12 - 433	42
M8 - 1328	39	M8-1558	35	M12 - 800	59, 61
M8 - 1329	39	M8-1559	35	M12 - 1101	60
M8 - 1330	39	M8-1560	35	M12 - 1201	58
M8 - 1331	39	M8-1570	35	M14 - 310	5, 54, 56
M8 - 1332	39	M8-1571	35	M14 - 700	4, 54, 56
M8 - 1333	39	M8-1572	35	M14 - 800	5, 55, 57
M8 - 1334	39	M8-1573	35	M14 - 1100	57, 61
M8 - 1420	41	M8-1574	35	M14 - 1101	56
M8 - 1421	41	M8-1575	35	M14 - 1105	57, 61
M8 - 1422	41	M8-1576	35	M14 - 1200	55, 59
M8 - 1423	41	M8-1577	35	M14 - 1201	54
M8 - 1424	41	M8-1578	35	M14 - 1230	55, 58
M8 - 1425	41	M8-1579	35		
M8 - 1426	41	M8-1580	35		
M8 - 1427	41	M9 - 167	58, 60		
M8 - 1428	41	M9 - 168	58, 60		
M8 - 1429	41	M9 - 250	43		
M8 - 1430	41	M9 - 251	43		
M8 - 1431	41	M9 - 252	43		
M8 - 1432	41	M10 - 100	48, 52		
M8 - 1433	41	M10 - 101	49		
M8-1520	35	M10 - 102	49, 53		
M8-1521	35	M10 - 103	48		
M8-1522	35	M10 - 104	49, 53		
M8-1523	35	M10 - 105	52		
M8-1524	35	M10 - 110	50		
M8-1525	35	M10 - 111	50		
M8-1526	35	M10 - 112	50		
M8-1527	35	M10 - 113	50, 52		
M8-1528	35	M10 - 121	52		
M8-1529	35	M10 - 130	49, 53		
M8-1530	35	M11 - 500	62		
M8-1550	35	M11 - 600	63		
M8-1551	35	M11 - 605	63		
M8-1552	35	M12 - 201	43		

HSM Micro System



2015

Meeting Point For Surgery

AYGUN®
SURGICAL INSTRUMENTS CO., INC.

Organize Sanayi Bölgesi 55330
Kutlukent - SAMSUN / TÜRKİYE
Tel : 90 (362) 266 66 80 pbx
Fax : 90 (362) 266 93 30 pbx
E-Mail : aygun@aygun.com

www.aygun.com