

Power System

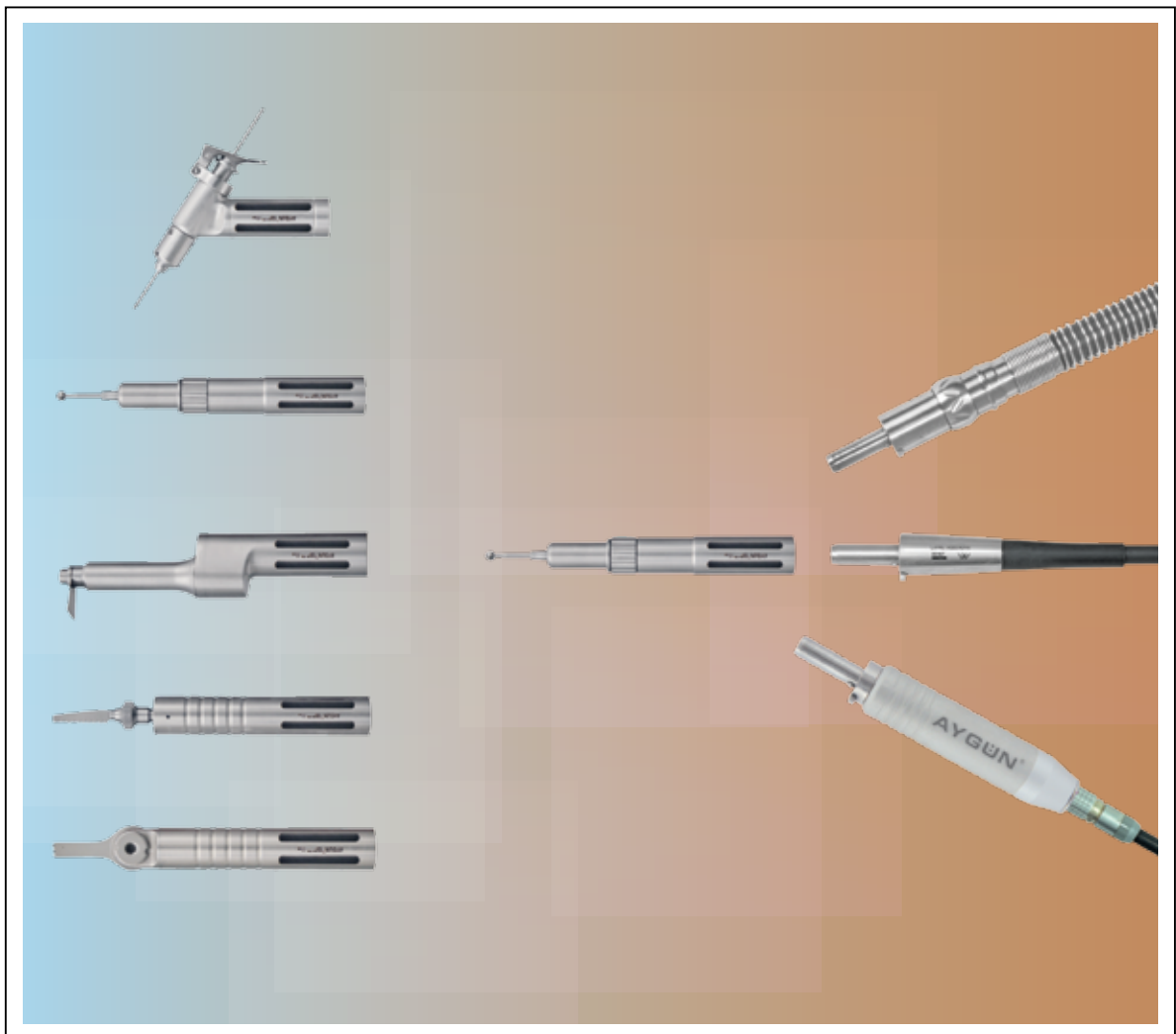

- *Electro*
- *Transmission Cable*
- *Pneumatic*

MINI
Surgical Motor

www.aygun.com

AYGÜN[®]
SURGICAL INSTRUMENTS CO., INC.

Organize Sanayi Bölgesi 55330
Kutlukent - SAMSUN / TÜRKİYE
Tel : 90 (362) 266 66 80 pbx
Fax : 90 (362) 266 93 30 pbx
E-Mail : aygun@aygun.com
Web : <http://www.aygun.com>

Edition 6

■ According to the production programme
Aygün's rights is reserved in production to improve,
modify or delete the products declared in this catalog.

KA - 4008-Y1 Copyright © Aygün Co., Inc
2014 All Right Reserved, Printed in Türkiye



AYGÜN, one of the leading establishment of Turkey in the medical industrial field, starting from neurosurgical field since 1988, at the end of its constantly R&D researches, has accomplished the production of instruments for all surgical branches. Along with meeting a large part of Turkey's requirements, it proves itself as an expert in the field with the products offered to the world market.

With present catalogues that include standard products and the special products formed on the request of the doctors including approximately 22.000 different types of instruments produced by AYGÜN. Besides being a manufacturer, it is also a designer firm.

Besides increasing its capacity, AYGÜN, in its new production plants constructed in the Organized Industrial Area of Samsun, aims to present the different models of products to the medical community.

ISO 13485:2003
CERTIFIED



ISO 9001:2008
CERTIFIED

www.aygun.com

AYGUN®
SURGICAL INSTRUMENTS CO., INC.

Power System



PRAXIS Battery + Electro Surgical Motor

Edition 7

AYGUN®
SURGICAL INSTRUMENTS CO., INC.

Power System



HSM High Speed Motor

90.000 rpm

Edition 6

AYGUN®
SURGICAL INSTRUMENTS CO., INC.

Power System

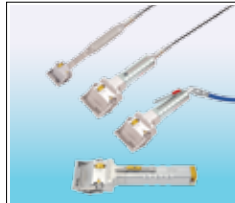

DERMATOME For Skin Transplantation

Edition 6

AYGUN®
SURGICAL INSTRUMENTS CO., INC.

Power System



COMPACT Sternal Saw

Battery + Electro Surgical Motor

Edition 6

AYGUN®
SURGICAL INSTRUMENTS CO., INC.

Power System

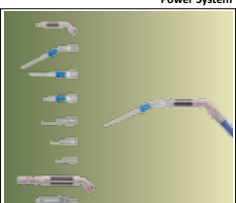

NAP Neuro Air Power Surgical Motor

Edition 6

AYGUN®
SURGICAL INSTRUMENTS CO., INC.

Power System



Electro Transmission Cable Pneumatic

STANDARD MICRO Surgical Motor

Edition 6

AYGUN®
SURGICAL INSTRUMENTS CO., INC.

Power System

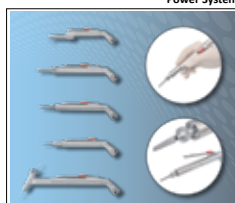

Mini COMPACT Pneumatic Surgical Motor

Edition 6

AYGUN®
SURGICAL INSTRUMENTS CO., INC.

Power System

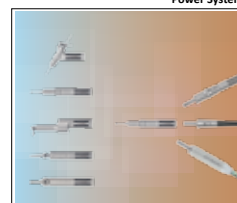

Mini Electro / Pneumatic Surgical Motor

Edition 6

AYGUN®
SURGICAL INSTRUMENTS CO., INC.

Power System



STANDARD MACRO Electro (Transmission) / Pneumatic Surgical Motor

Edition 6

AYGUN®
SURGICAL INSTRUMENTS CO., INC.

Power System

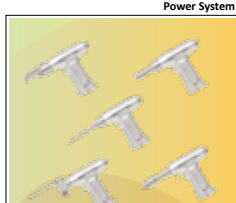

EPS Electro (Transmission) Pneumatic Surgical Motor

Edition 6

AYGUN®
SURGICAL INSTRUMENTS CO., INC.

Power System



Macro COMPACT Pneumatic Surgical Motor

Edition 6

AYGUN®
SURGICAL INSTRUMENTS CO., INC.

Power System



MOBIL STATOR For Surgical Motor

Edition 6



Mini Drill Attachment



Mini Oscillating Attachment



Mini Sagittal Attachment



Mini Straight Reciprocating Attachment



*Wire Driver
For Fixating Small Bones*



Pneumatic-Surgical Motor System



M8-110
M8-111



M7-230



M8-102



M8-103



M8-114

**Electro-Surgical Motor System
(Transmission Cable)**



M6-065
M6-066



M6-034



M6-055

Electro-Surgical Motor System



M14-310



M14 - 700

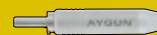

M14-800



M6-054

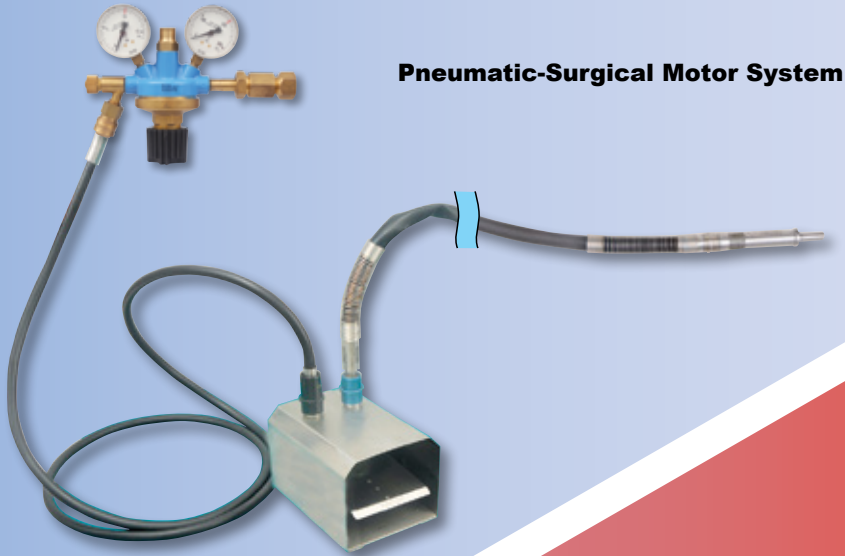

Electro-Surgical Motor System
(Transmission Cable)

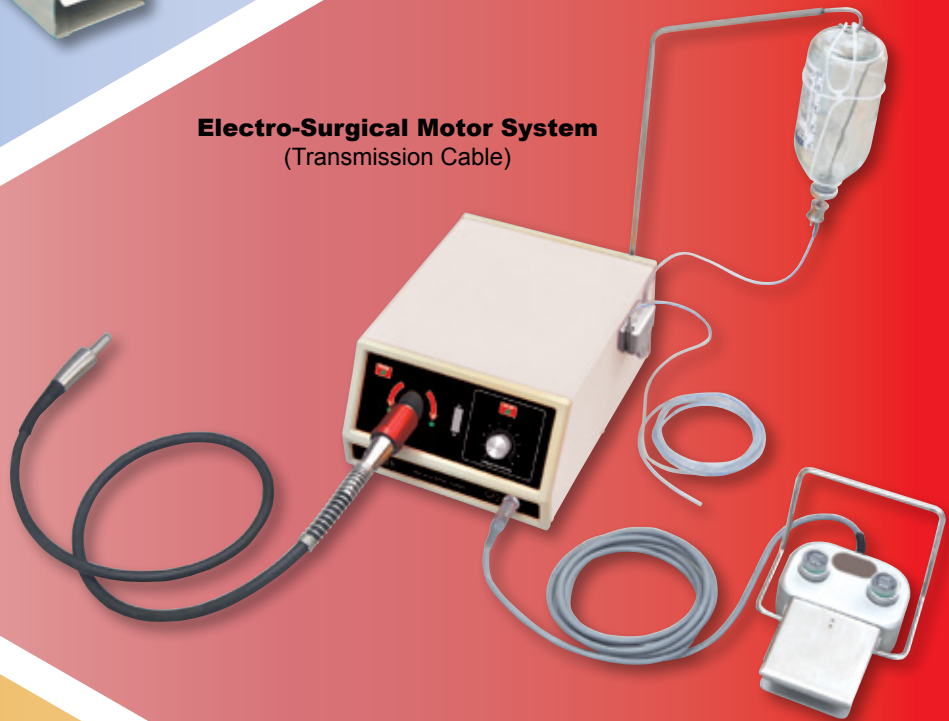

Electro-Surgical Motor System



M6 - 109
Silicone tube, 10 cm

M6 - 112
Silicone tube, 240 cm

M6 - 105
Punch for 500 ml
Solution bottles

M6 - 106
Punch for 1000 ml
Solution bottles

M6 - 107
Silicone tube, 35 cm

M6 - 120
Tubing Set
(M6-105, M6-107, M6-109, M6-112)

M14 - 310
Motor Cable
Use with M14-700

M14 - 800 Electric motor
40.000 rpm

M6 - 054
Foot control pedal, For electronically controlled speed regulation. Connection to M14-700 including push button for forward and reverse gear and push button for irrigation on/off With 4 m. long cable.

M14 - 700 Power Console
40.000 rpm

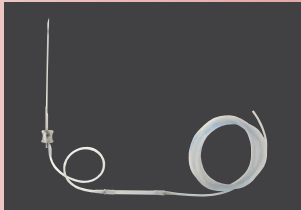

M6 - 120
Tubing Set
(M6-105, M6-107, M6-109, M6-112)

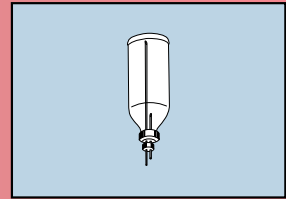

M6 - 105
Punch for 500 ml
Solution bottles

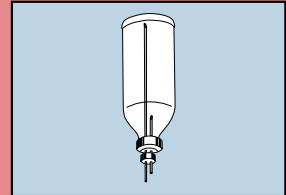

M6 - 106
Punch for 1000 ml
Solution bottles



M6 - 107
Silicone tube, 35 cm

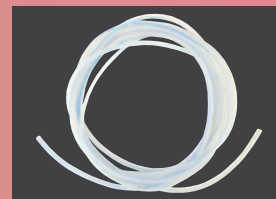

M6 - 112
Silicone tube,
240 cm



M6 - 109
Silicone tube, 10 cm



M6 - 065 180 cm
M6 - 066 230 cm
Autoclave up to max. 3 bar, 143°C

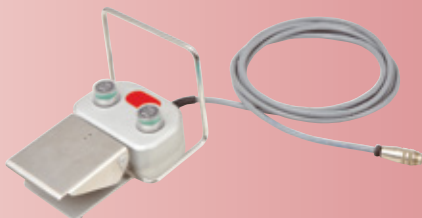

M6 - 055
Foot control pedal, For electronically controlled speed regulation. Connection to M6-034 including push button for forward and reverse gear and push button for irrigation on/off With 4 m. long cable.



M6 - 034
Electro-surgical motor with forward and reverse gear to be used with flexible cables M4-137, M4-138, M6-060, M6-061, M6-065, M6-066 sound and light signal warning start at reverse running position. Foot control M6-054 (Foot control, flexible cable and hand piece have to be ordered separately)

For security; the systems must be operated by using compressed dry air or nitrogen gas, the oxygen gas must never be used.



M7 - 230 B
Air pressure reducer, two way



M7 - 230
Air pressure reducer, one way

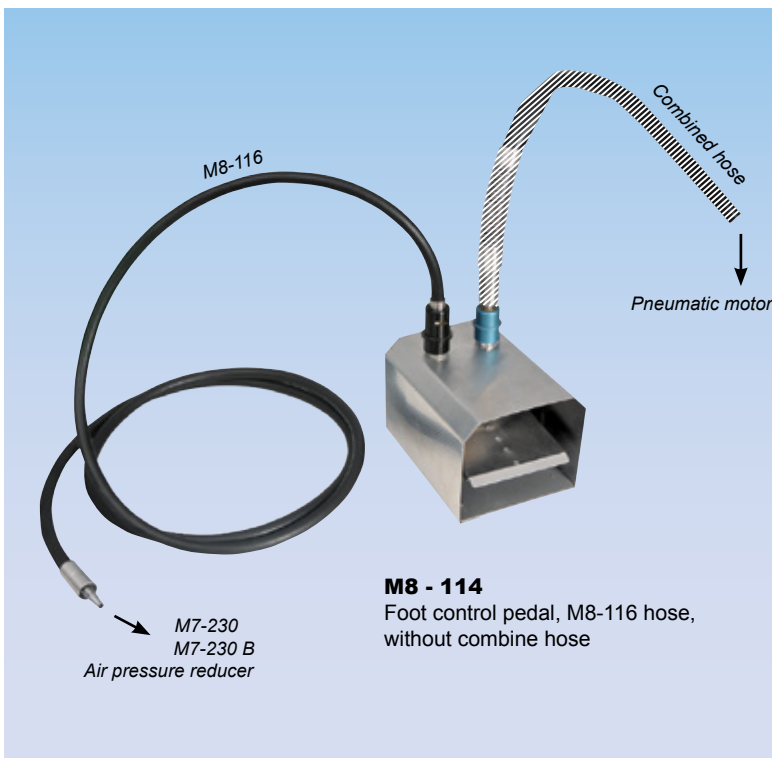

M8 - 114
Foot control pedal, M8-116 hose, without combine hose



M8 - 110 3 m
M8 - 111 5 m
Combine hoses for air supply (for M7-230 and M8-102, M8-103)
Sterilization= 3 Atm 134° C

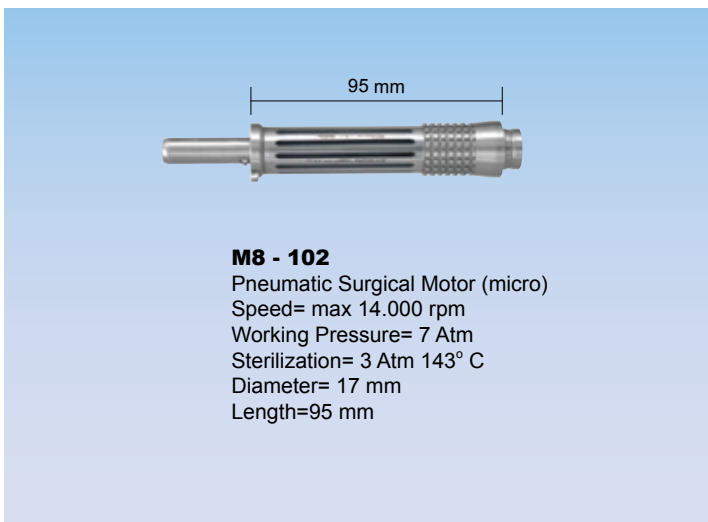

M8 - 102
Pneumatic Surgical Motor (micro)
Speed= max 14.000 rpm
Working Pressure= 7 Atm
Sterilization= 3 Atm 143° C
Diameter= 17 mm
Length=95 mm

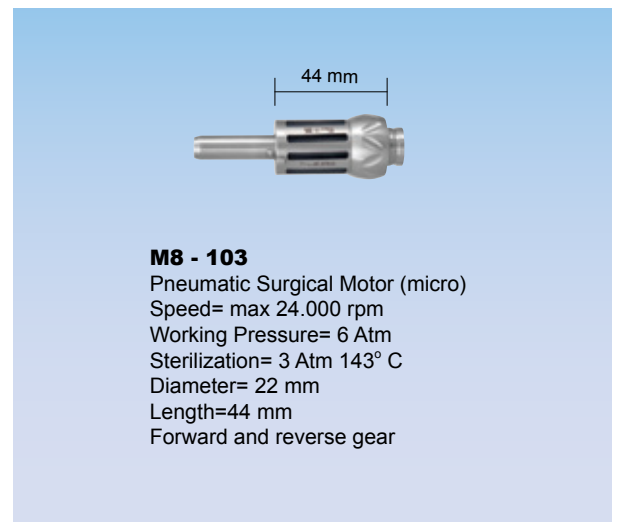

M8 - 103
Pneumatic Surgical Motor (micro)
Speed= max 24.000 rpm
Working Pressure= 6 Atm
Sterilization= 3 Atm 143° C
Diameter= 22 mm
Length=44 mm
Forward and reverse gear

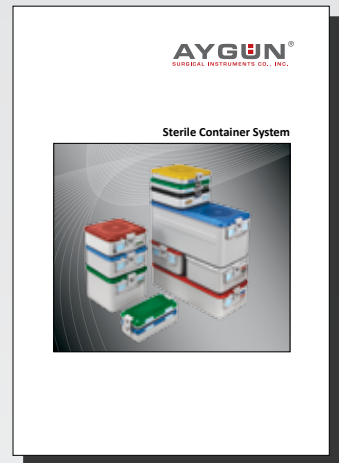

For more information and alternative please see our Sterile Container System catalog.

M14 - 816
Spray oil



M14 - 818
Attachment for Intra

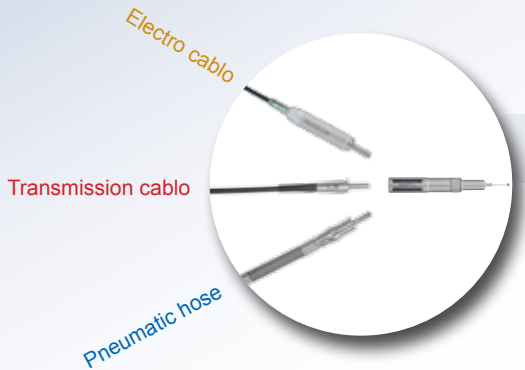

Mini Drill Attachment

MICRO DRILL



M12 - 300
Mini Drill
No key is needed
Only use with pneumatic system
See page 6 for space cutters

1/1

BURRS-SHANK 70 mm LONG, SHANK Ø 2.35 mm, ROUND SHANK

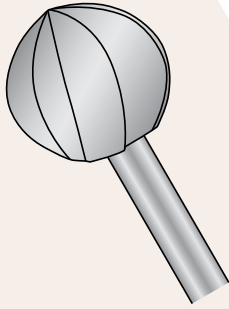



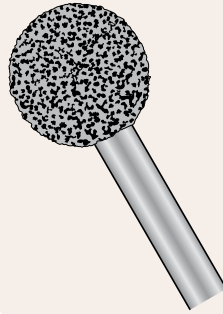



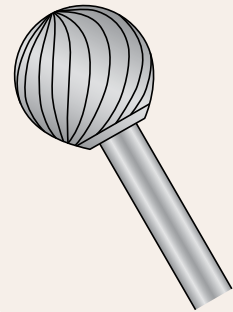





ROSEN
Stainless steel

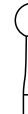

DIAMOND



HIGH SPEED
Tungsten

											
 ROSEN	M8-1520	M8-1521	M8-1522	M8-1523	M8-1524	M8-1525	M8-1526	M8-1527	M8-1528	M8-1529	M8-1530
 DIAMOND	M8-1550	M8-1551	M8-1552	M8-1553	M8-1554	M8-1555	M8-1556	M8-1557	M8-1558	M8-1559	M8-1560
 HIGH SPEED	M8-1570	M8-1571	M8-1572	M8-1573	M8-1574	M8-1575	M8-1576	M8-1577	M8-1578	M8-1579	M8-1580

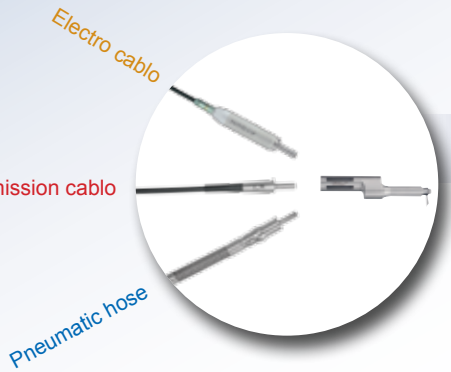

Mini Oscillating Attachment

OSCILLATING SAW



M12 - 360
Micro Oscillating saw
Oscillating degree is 7°
The cutting blade is replaced by using the key in cutting the bones in the limited areas.
Only use with pneumatic system
See page No: 8 for spare cutters
with keys M7-320



M7 - 320
Key only,
for changing
saw blades

MINI OSCILLATING SAW

M8 - 1220

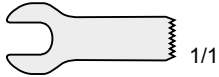

M8 - 1221



M8 - 1222

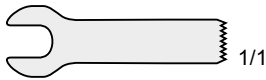

M8 - 1223

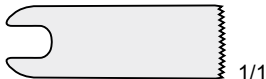

M8 - 1224

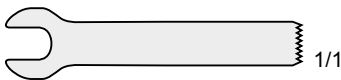

M8 - 1225



M8 - 1226

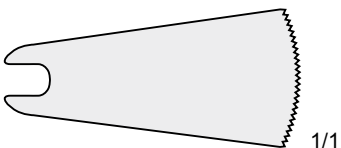

M8 - 1227

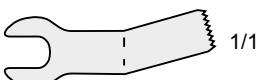

M8 - 1228



M8 - 1229



M8 - 1230

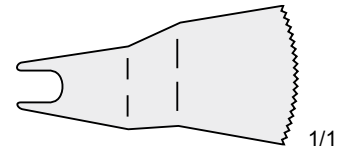

M8 - 1231

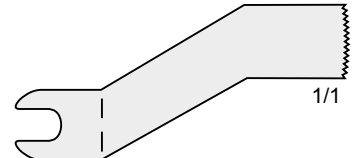

M8 - 1232

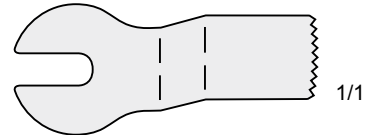

M8 - 1233



M8 - 1234

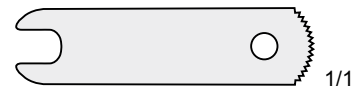

M8 - 1235

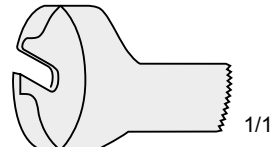

M8 - 1236

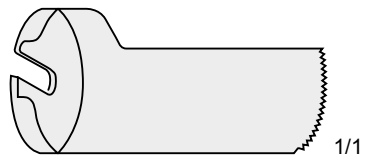

M8 - 1237



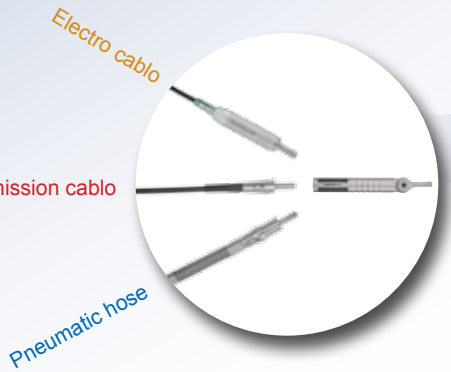

Transmission cable

Pneumatic hose

Electro cable

Mini Sagittal Attachment

SAGITTAL SAW

M12 - 380

Mini Sagittal saw
It is used in deep cutting the bones and other small bones in the mandibular and maxillofacial surgery.
The cutting blade is replaced by key
Only use with pneumatic system
See page No: 10 for spare cutters with keys M7-320



1/1



M7 - 320
Key only,
for changing
saw blades

MINI SAGITTAL SAW

M8 - 1320

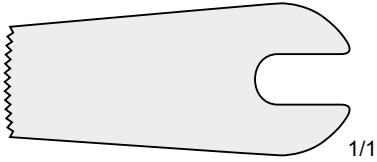

1/1

M8 - 1321

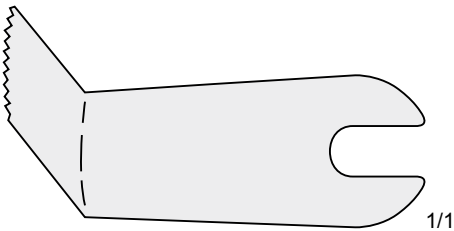

1/1

M8 - 1322

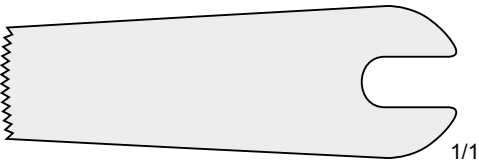

1/1

M8 - 1323

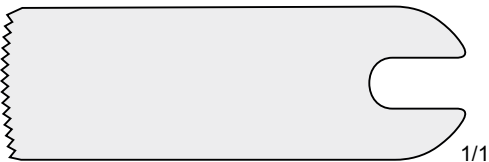

1/1

M8 - 1324

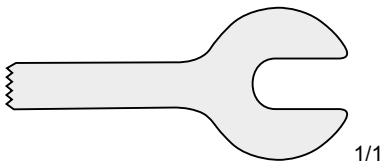

1/1

M8 - 1325

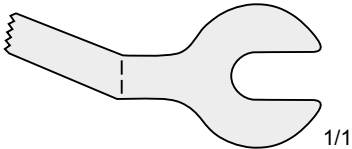

1/1

M8 - 1326

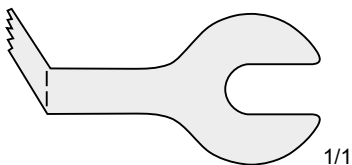

1/1

M8 - 1327



1/1

M8 - 1328



1/1

M8 - 1329

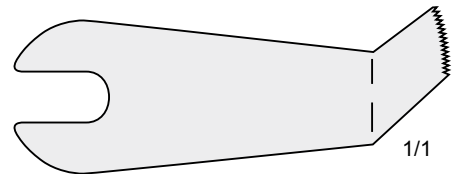

1/1

M8 - 1330

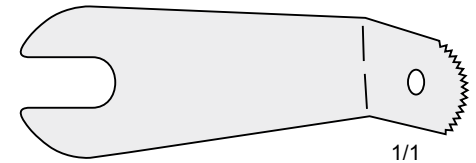

1/1

M8 - 1331

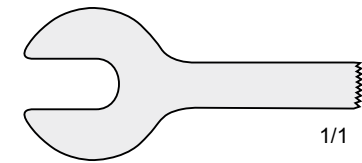

1/1

M8 - 1332

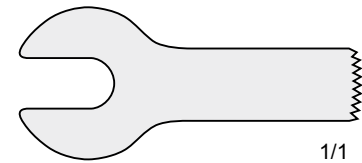

1/1

M8 - 1333

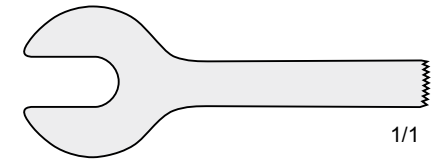

1/1

M8 - 1334

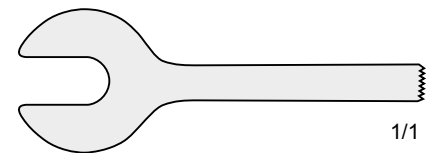

1/1

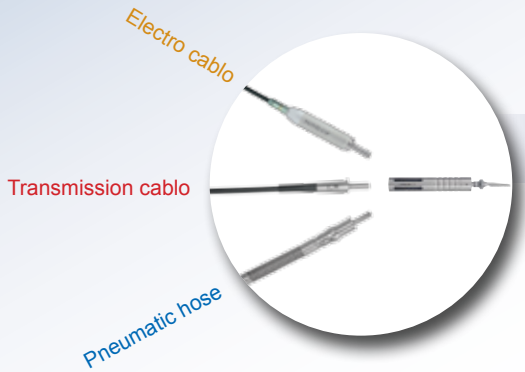











Mini Straight Reciprocating Attachment

RECIPROCATING SAW

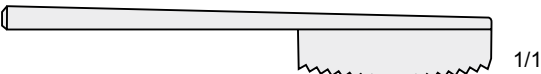

M12 - 423
Straight reciprocating saw
It is used in deep cutting the bones and other small bones in the mandibular and maxillofacial surgery.
No need for key to replace the blades
Only use with pneumatic system 1
See page No: 12 for spare cutters

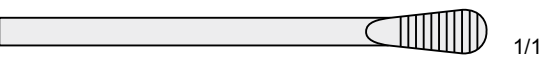
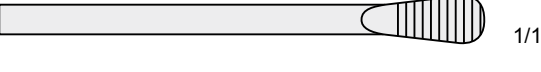
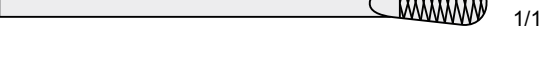
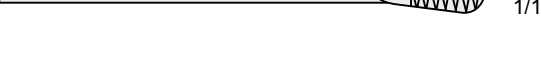
MINI RECIPROCATING SAW BLADES

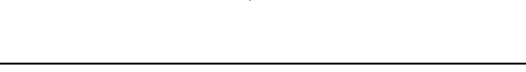
M8 - 1420		1/1
M8 - 1421		1/1
M8 - 1422		1/1
M8 - 1423		1/1
M8 - 1424		1/1
M8 - 1425		1/1
M8 - 1426		1/1
M8 - 1427		1/1
M8 - 1428		1/1
M8 - 1429		1/1
M8 - 1430		1/1
M8 - 1431		1/1
M8 - 1432		1/1
M8 - 1433		1/1

Wire Driver

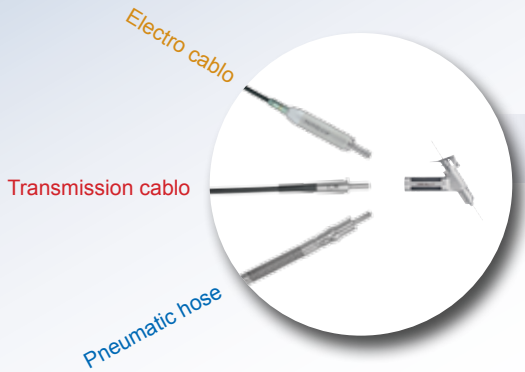

FOR FIXATING SMALL BONES



1/1

M12 - 433
K - Wire Driver
for fixating small bones
Ø 0.6 mm - 1.6 mm
Cannulated

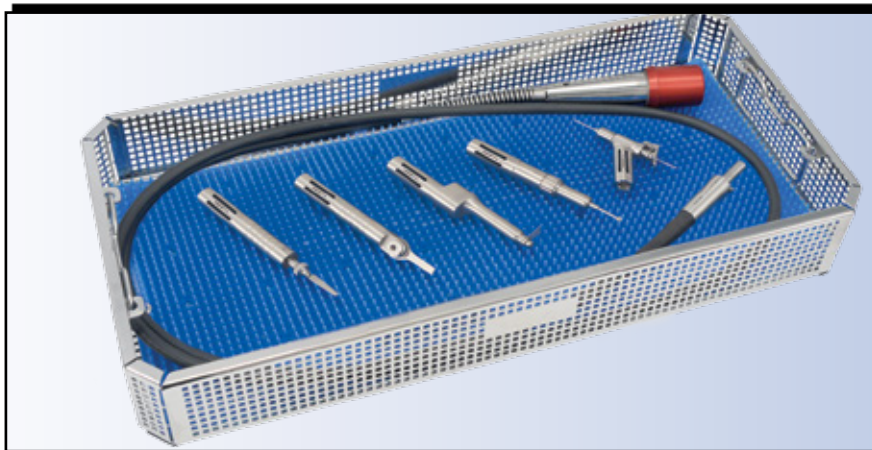
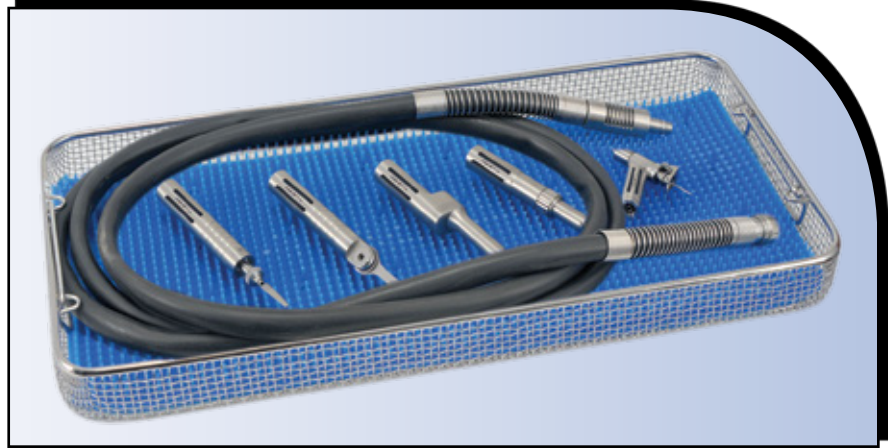

Power System

MINI ELECTRO / PNEUMATIC



Edition 6

Meeting Point For Surgery

AYGUN[®]
SURGICAL INSTRUMENTS CO., INC.

Organize Sanayi Bölgesi 55330
Kutlukent - SAMSUN / TÜRKİYE
Tel : 90 (362) 266 66 80 pbx
Fax : 90 (362) 266 93 30 pbx
E-Mail : aygun@aygun.com
Web : <http://www.aygun.com>

www.aygun.com